



PROCEEDING The 1st International Seminar of Science and Technology for Society Development ISST 2021

Science and Technology for Society 5.0



*Editors:
Siti Hadijah H
Fawzi Rahmadiyan Z*



*Faculty of Science and Technology,
14 October 2021*

PENERBIT UNIVERSITAS TERBUKA

The 1st International Seminar of Science and Technology for Society Development ISST 2021

Proceeding

International Seminar of Science and Technology, Science and Technology for Society 5.0

Tempat dan Tanggal Pelaksanaan: Fakultas Sains dan Teknologi, Universitas Terbuka, 14 Oktober 2021

Committee Head	: Dr. Subekti Nurmawati, M.Si. (Universitas Terbuka)
Conference Chair	: Dr. Ir. Isfarudi, M.Pd. (Universitas Terbuka)
Conference Co-Chair	: Adhi Susilo, S.Pt., M.biotech.St., Ph.D. (Universitas Terbuka)
Secretariat	: Siti Hadijah Hasanah, S.Si., M.Si. (Universitas Terbuka) : ing. Mohamad Rajih Radiansyah, B.AS., M.Sc. (Universitas Terbuka)
Finance Committee	: Ir. Endang Indrawati, M.A. (Universitas Terbuka) : Riyanto, S.IP. (Universitas Terbuka)
Scientific Committee	: Dr. Yuni Tri Hewindati (Universitas Terbuka) : Hedi Heryadi, S.P., M.Si. (Universitas Terbuka)
Event Management Committee	: Dian Nurdiana, S.Kom.,M.Kom. (Universitas Terbuka) : Athiefah Fauziyyah, S.T.P., M.Si. (Universitas Terbuka)
External Affairs Committee	: Drs. Sumartono, M.Si. (Universitas Terbuka) : Ir. Sri Yuniati Putri Koes Hardini, M.P. (Universitas Terbuka)
Publication Committee Administrator	: Effendi Hansori, S.Kom. (Universitas Terbuka) : Mahdy Eka Putra, S.Kom. (Universitas Terbuka)
Editor	: Siti Hadijah Hasanah, S.Si., M.Si. (Universitas Terbuka) : Fawzi Rahmadiyan Zuhairi, S.Si., M.Sc. (Universitas Terbuka)

Penyunting:

1. Siti Hadijah Hasanah, S.Si., M.Si.
2. Fawzi Rahmadiyan Zuhairi, S.Si., M.Sc.

Penata letak: Tomi Guntara, A.Md.

Perancang Kover dan Ilustrasi: Faisal Zamil, S.Des.

ISBN: 978-623-312-829-2

e- ISBN: 978-623-312-830-8

Penerbit:

Universitas Terbuka

Kementrian Pendidikan, Kebudayaan, Riset, dan Teknologi

Jalan Cabe Raya, Pondok Cabe, Pamulang, Tangerang Selatan - 15437

Banten – Indonesia

Telp.: (021) 7490941 (hunting); Fax.: (021) 7490147

Laman: www.ut.ac.id.

Cetakan pertama.....2021

© 2021 oleh Universitas Terbuka



Buku ini di bawah lisensi *Creative Commons* Atribusi Nonkomersial Tanpa turunan 4.0 Internasional oleh Universitas Terbuka, Indonesia. Kondisi lisensi dapat dilihat pada [Http://creativecommons.or.id/](http://creativecommons.or.id/)

Universitas Terbuka : Katalog Dalam Terbitan (Versi RDA)

Nama : Universitas Terbuka

Judul : The 1st International Seminar of Science and Technology for Society Development ISST 2021 : Proceeding International Seminar of Science and Technology, Science and Technology for Society 5.0 (BNBB) / penyunting, Siti Hadijah Hasanah, S.Si., M.Si., Fawzi Rahmadiyan Zuhairi, S.Si., M.Sc. ; penata letak, Tomi Guntara, A.Md. ; perancang kover dan ilustrasi, Faisal Zamil, S.Des.

Cetakan : 1

Deskripsi : Tangerang Selatan : Universitas Terbuka, 2021 | 453 halaman ; 21 cm
(termasuk daftar referensi)

ISBN : 978-623-312-829-2

e-ISBN : 978-623-312-830-8

Subyek : 1. Teknologi

2. Technology

Nomor klasifikasi : 600 [23]

202200040

Dicetak oleh

FOREWORD
OPENING GREETING BY ISST CHAIRMAN

**The 1st International Seminar of Science and Technology
for Society Development
“Science and Technology for Society 5.0”**

Bismillahirrohmanirrohiim.

Assalammu'alaikum Warahmatullahi Wabarakatuh.

Good morning and welcome to our Honourable Guests,

- Prof. Ir. Nizam, M.Sc., DIC, Ph.D., IPU, Asean Eng. – Director General of Higher Education, Research and Technology of The Ministry of Education, Culture, Research and Technology;
- Prof. Shoba Ranganathan – Professor at Macquarie University, Sydney, Australia;
- Kholis Abdurachim Audah Ph.D – Associate Professor at Swiss German University, Indonesia;
- Mohammad Asif Khan, PhD – Associate Professor at Perdana University, Malaysia;
- Prof. Dr. Hafizan bin Juahir- Professor at Universiti Sultan Zainal Abidin, Malaysia;
- Dr. Waseem Haider – Associate Professor at Central Michigan University, USA;
- Dr. Ernik Yuliana, S.Pi., M.T. – Associate Professor at Universitas Terbuka, Indonesia;
- Prof. Drs. Ojat Darajat, M.Bus., Ph.D., Rector of Universitas Terbuka, Indonesia;
- Dr. Subekti Nurmawati, M.Si., Dean of Faculty of Science and Technology, Universitas Terbuka, Indonesia;
- And all seminar presenters and participants.

First, as the chairman of the ISST (International Seminar of Science and Technology), Faculty of Science and Technology, Universitas Terbuka, I would like to welcome all participants of the seminar, may we always be in good health during Covid-19 pandemic. This year is a special year for us, especially for the Faculty of Science and Technology, because we are able to organize the first international seminar with the theme "**Science and Technology for Society 5.0**". We are very grateful with the full support given by the Rector of Universitas Terbuka and several partners involved in this seminar. On behalf of the committee, I would like to express my deepest gratitude.

The global pandemic of Covid-19 has brought changes in various aspects of life, including the development of science and technology. The era of Society 5.0 is a concept of a human-centered and technology-based society that encourage the society to adapt to current essential needs. Such adaptation is indeed a challenge for the development of current and, more importantly, future society. During Covid-19 pandemic, information technology plays an important role in human or society's behaviour. Before the pandemic, activities carried out mostly involve physical presence. However, since the pandemic, a lot of human activities can be assisted by various technologies to reduce the spread of the virus infection.

The realization of a safe, comfortable, productive, and sustainable spatial plan is a challenge for experts and researchers to develop methods for managing environmental development plans in the Covid-19 era. Moreover, good health and food are very important for dealing with the current pandemic. Therefore, this crisis in the current global pandemic is an opportunity for all expertise, especially scientist, to reflect on the concept of Society 5.0 so that it can be applied comprehensively and have a positive impact on all of us. We hope that this international seminar can accommodate discussions of many strategic issues related to Science and Technology for Society 5.0.

We have received a total of 52 scientific articles from academics, practitioners, and lecturers from various institutions. The articles are classified into three sub-themes, namely: “Big Data Science and Information Technology”, “Food Security and Health”, and “Biodiversity for Sustainable Environment”. All articles submitted will be part of the proceeding publication of the International Seminar of Science and Technology for Society Development 2021.

Within this seminar, we have also compiled a seminar book that comprises of various ideas and work of our faculty lecturers and other academics regarding the role of science and technology in this era of 5.0 society related to the three sub-themes of this seminar. This book contains 14 articles that involved 23 internal writers and 5 external writers from outside of Universitas Terbuka. The book will be launched as the beginning of our main activity series of the 1st International Seminar of Science and Technology.

Lastly, please enjoy the seminar. We hope that you will have a pleasant experience during the seminar, both in the form of useful scientific knowledge as well as networking experience with various experts involved.

Thank you,
Wassalamu’alaikum Warahmatullahi Wabarakatuh.
Tangerang Selatan, 14th of October 2021

Signed

Dr. Ir. Isfarudi, M.Pd.
Chairman of International Seminar of Science and Technology for
Society Development, Faculty of Science and Technology,
Universitas Terbuka

**GREETING BY FACULTY OF SCIENCE AND TECHNOLOGY
DEAN OF UNIVERSITAS TERBUKA**

**The 1st International Seminar of Science and Technology
for Society Development
“Science and Technology for Society 5.0”**

Assalammu'alaikum Warahmatullahi Wabarakatuh.

Good morning and best wishes to all of us.

Honorable:

- Prof. Ir. Nizam, M.Sc., DIC, Ph.D., IPU, Asean Eng. – Director General of Higher Education, Research, and Technology of The Ministry of Education, Culture, Research, and Technology;
- Prof. Shoba Ranganathan – Professor at Macquarie University, Sydney, Australia;
- Kholis Abdurachim Audah Ph.D. – Associate Professor at Swiss German University, Indonesia;
- Mohammad Asif Khan, Ph.D. – Associate Professor at Perdana University, Malaysia;
- Prof. Dr. Hafizan bin Juahir- Professor at Universiti Sultan Zainal Abidin, Malaysia;
- Dr. Waseem Haider – Associate Professor at Central Michigan University, USA;
- Dr. Ernik Yuliana, S.Pi., M.T. – Associate Professor at Universitas Terbuka, Indonesia;
- Rector, Vice Rectors, and all leaders of Universitas Terbuka, Indonesia;
- And a very good morning to all participants,

First, praise is to Allah SWT because with His permission, today we are all able to attend the "The 1st International Seminar of Science and Technology". This event is organized by the Faculty of Science

and Technology, Universitas Terbuka, Indonesia, with the theme "Science and Technology for Society 5.0".

Allow me to thank all of you for taking the time to participate, both as keynote speakers, invited speakers, presenters, and as participants, in this seminar. This is the first international seminar held by us, the Faculty of Science and Technology, and we plan to organize the seminar as a yearly event.

The big theme of this year's seminar is "Science and Technology for Society 5.0", with three main sub-themes, namely: "Big Data Science and Information Technology"; "Food Security and Health"; and "Biodiversity for Sustainable Environment".

The theme was chosen because we realize that the role of science and technology is very important, especially in overcoming every challenge and dynamic change in life.

The role of science and technology is like a double-edged sword: in one hand we can use it to overcome problems such as identifying natural changes, analyzing social phenomena in our society, and finding solutions related to the disasters we are currently experiencing together, a global pandemic of Covid-19. However, on the other hand, the application of technology without precaution and proper humanity policy can also lead to disaster.

Dear honorable guests, keynote speakers, presenters, and all participants,

Roles of science and technology have evolved now that we are entering the Society 5.0 era. Therefore, it is important to take advantage of technological advancement to improve the quality of human life without damaging the environment and social structures.

Optimization of many novel discoveries and applications in science and technology, usually involves data collection, processing, analysis, interpretation, and data presentation. Of course, the use of any technological advancement must be carried out in all fields of knowledge in synergy: from food technology, agribusiness, biology, urban and regional planning, mathematics, statistics, information systems, etc.

Therefore, technology utilization involving a multidisciplinary approach will provide different perspectives to tackle many essential human or society problems globally, and we hope that this seminar will provide a pleasant experience to all of you for discussing such phenomena.

Lastly, I would like to thank you for all the support from various parties, that this seminar can run well from the 1st day of preparation until today. And to everyone, we hope you have a great time in today's seminar, and we look forward to a very exciting scientific discussion today!

Thank you,
Wassalamualaikum WrWb.
Tangerang Selatan, 14th of October 2021

Signed

Dr. Subekti Nurmawati, M.Si.
Dean of Faculty of Science and Technology, Universitas Terbuka

GREETING BY RECTOR OF UNIVERSITAS TERBUKA

The 1st International Seminar of Science and Technology for Society Development “Science and Technology for Society 5.0”

Bismillahirrahmanirrahim,

Assalammu’alaikum Warahmatullahi Wabarakatuh.

Good morning and best wishes to all of us.

To our esteemed guests,

- Prof. Ir. Nizam, M.Sc., DIC, Ph.D., IPU, ASEAN Eng. – Director General of Higher Education of The Ministry of Education, Culture, Research, and Technology;
- Prof. Shoba Ranganathan – Professor at Macquarie University, Sydney, Australia;
- Kholis Abdurachim Audah Ph.D. – Associate Professor at Swiss German University, Indonesia;
- Mohammad Asif Khan, Ph.D. – Associate Professor at Perdana University, Malaysia;
- Prof. Dr. Hafizan bin Juahir- Professor at Universiti Sultan Zainal Abidin, Malaysia;
- Dr. Waseem Haider – Associate Professor at Central Michigan University, USA;
- Dr. Ernik Yuliana, S.Pi., M.T. – Associate Professor at Universitas Terbuka, Indonesia;
- Vice rector and all leaders of Universitas Terbuka;
- Dr. Subekti Nurmawati M. Si, Dean of Science and Technology Faculty, and all staff;
- And to all ISST presenters and participants.

Welcome to Universitas Terbuka’s first annual Internasional Seminar of Science and Technology for Society Development. I thank you for your participation. First of all, let us be thankful for the good health that God gives, so we can attend this seminar virtually.

This seminar is organized by The faculty of science and technology of Universitas Terbuka and supported by several institutes such as Masyarakat Bio Informatika dan Biodiversitas Indonesia (MABBI) and Indonesian Operations Research Association (IORA).

On this blessed day, allow me to offer my deepest gratitude to everyone that has spare some time to participate, whether as keynote speakers, experts, presenters as well as participants, for this seminar.

Ladies and gentlemen,

This international seminar is part of our annual seminar program, which is being held as part of Universitas Terbuka Dies Natalis which is celebrated on the 4th of September every year. In our 37th anniversary this year, our Dies Natalis main theme is entitled **“Developing human capital excellence through digital learning ecosystem”**. To strengthen that theme, our science and technology faculty, which organize study programs in the field of science and technology, is holding this international seminar with a theme of **“Science and Technology for Society 5.0”**.

Distinguished colleagues and guests,

Humankind’s will to improve its’s quality of life, gave birth to several industrial revolutions, starting from the 18th century. As time passes by, the way people manage natural resources and produces various products, as well as services also revolutionize the means to process and develop them. The industrial revolution has evolved during human history, from its first around 1760 to the fourth, which we are all experiencing currently.

As technology develops, several challenges have come up that humankind has to face. One of those challenges is to figure out how to maintain our current standard of living without giving more pressure on the earth’s ecosystem. Many human activities are being influenced by its population number. Human population growth is one of the

biggest factors in environmental damages facing the earth today. The world's population constantly expands, with a 1,05% growth each year. Indonesia has one of the biggest increases in the human population, with 2.32% growth each year. This counts for 3,51% of the total human population growth on top of being one of the highest populated developing countries and around the world.

Ladies and gentlemen,

Increasing human population equals increasing needs, such as food and other necessities. Therefore, the need for more land use is greater than ever. Farming and industries will need space to comply with the product demand of the population. On the other hand, a higher population means the need for housing spaces will also increase. Thus, these conflicting needs will result in more land and natural resources exploitation. Another impact of this increasing housing demand is urbanization. With fewer land to farm, more and more people will try their luck in the city hence fewer human resources to take care of the farm. Increasing the urban population will also cause a problem in the city if not anticipated and maintained well. This will give rise to slums area, sanitary and health problems for the community.

To deal with these potential and current problems is still difficult to manage with our current technology and way of life. So, we would need to develop a new paradigm that is more human-focused. The thought that quality of life based only on technology is no more optimal in terms of efficiency and value. The question of how to manage and master technology for human development that synergizes with the protection of people and the environment has currently been asked. In Japan, this concept is conceived by the government, with the help of the academic community, to create a society that values and enjoys its life, known as society 5.0. This thought is a response to the 4th industrial revolution due to its high technological achievement but with minimum societal involvement. There is not a huge difference between the two concepts, however, whereas the 4th industrial revolution relies more on technological advancement and artificial intelligence, society

5.0 put more emphasis on its human component. Big data and artificial intelligence are being transformed into a new way to aid humankind in a more meaningful way.

Distinguished colleagues and guests,

Based on society 5.0 paradigm, science and technology have to help improve the quality of human life without impacting the environment and social structures. Big data, for example, is being used to solve environmental problems and challenges. Fields of science and technology such as food technology, agribusiness, biology, urban and regional planning, mathematics, statistics, and information technology play a part in solving these problems accurately and efficiently. Applied science and technology should involve multiple disciplines to efficiently solve problems using different perspectives.

To all our guests,

Those are the few hopes that I want to convey at this time. I pray that all of our guests, participants, and organizer of ISST are always blessed with good health and fortune. I hope today will be a moment where we could develop new ideas, exchange thoughts, and learn new as well as exciting concepts. whether you are a speaker, expert, presenter, or participant, I, and the rest of the ISST team, wish you an enjoyable and educational time in this seminar.

Thank you for your attention,
Tangerang Selatan, 14th of October 2021

Signed

Prof. Ojat Darajat, M.Bus., Ph.D
Rector of Universitas Terbuka

TABLE OF CONTENTS

OPENING GREETING BY ISST CHAIRMAN	iii
GREETING BY FACULTY OF SCIENCE AND TECHNOLOGY	
DEAN OF UNIVERSITAS TERBUKA	vi
GREETING BY RECTOR OF UNIVERSITAS TERBUKA	ix
TABLE OF CONTENTS	xiii

SUB THEME: BIG DATA SCIENCE AND INFORMATION TECHNOLOGY

STATISTICAL INFERENCE-BASED DECISION MAKING FOR SMALL AND MEDIUM-SIZED ENTERPRISE	
Suparman	1-16
IMPLEMENTATION K-MEDOIDS ALGORITHM FOR DISTRIBUTION MAPPING OF COVID-19 IN SURABAYA	
Vivi Mentari Dewi, Iis Dewi Ratih	17-26
N-SOFT SETS: LITERATURE REVIEW AND RESEARCH POTENTIAL	
Fatia Fatimah	27-39
MODEL OF BEHAVIOR OF THE PALU CITIZENS IN USING ONLINE SIM REGISTRATION WEB FOR SIM A AND SIM C: TECHNOLOGY ACCEPTANCE MODEL PERSPECTIVE	
Shine Pintor Siolemba Patiro, Hety Budiyantri, Lasando Lumbangaol, Diah Aryani	40-83
COMPUTER REPAIR MONITORING SYSTEM DESIGN IN THE COMPANY	
Agni Isador Harsapranata	84-95
SENTIMENT ANALYSIS TO DETERMINE THE POPULARITY OF THE MARKETPLACE USING THE NAIVE BAYES CLASSIFIER METHOD	
Adinda Rizka Chlorine Subagyo, Wahyu Wibowo	96-112

IMPLEMENTATION OF TOPIC MODELLING WITH LATENT
 DIRICHLET ALLOCATION (LDA) ON THE JUDGE'S
 DECISION

Hanipar Mahyulis Sastriana, Wiwit Pura Nurmayanti, Lukmanul Hakim	113-128
COMPARATIVE ANALYSIS OF CLASSIFIER FOR BRI CUSTOMERS PATTERN PREDICTION USING NAIVE BAYES, KNN AND RANDOM FOREST	
Atria, Wiwit Pura Nurmayanti, Umam Hidayaturohman, Ristu Haiban Hirzi	129-140
IMPLEMENTATION OF EXPONENTIAL SMOOTHING AND ARIMA ON COLLECTION AND DISTRIBUTION DATA OF ZAKAT, INFAQ AND SHADAQAH 2015-2020	
Sopiana Indra Wardani, Wiwit Pura Nurmayanti, Siti Arni Wulandya, Muhammad Gazali	141-153
ANALYSIS OF DIAGNOSIS CLASSIFICATION OF DENGUE HEMORRHAGIC FEVER (DHF) USING RANDOM FOREST AND BAGGING METHOD WITH IMBALANCED CLASS RESAMPLING TECHNIQUE	
Nurhidayah, Muhammad Gazali, Siti Arni Wulandya	154-168
OUTLIER DETECTION ON STUDENT REPORT VALUES USING DENSITY-BASED APPROACH LOCAL OUTLIER FACTOR METHOD	
Dinda Ayu Lara Saky, Ristu Haiban Hirzi, Lukmanul Hakim	169-180
ANALYSIS THE EFFECT OF LINK BUILDING USING SOCIAL MEDIA ON MULTI UMAH WEBSITE	
Diah Aryani, Shine Pintor Siolemba Patiro, Aji Setiawan .	181-191
DEVELOPMENT OF WEB-BASED FACILITY SURVEY SYSTEM IN COLLEGE OF VOCATIONAL STUDIES IPB UNIVERSITY	
Walidatush Sholihah, Fendrina Yoarbanu Tjitra, Wina Yulianty, Nur Aziezhah	192-209

SUB THEME: FOOD SECURITY AND HEALTH

ANTIBACTERIAL EFFECTIVENESS OF *EICHOORNIA CRASSIPES SOLMS.* EXTRACT AGAINST SELECTED BACTERIA ISOLATES *IN VITRO*

Lia Yulia Budiarti, Muhammad Bayu Wirabuana,

Muhammad Haris Al Ghipari, Nur Sa'adah Ramadhani,

Silvia Putri Ambarini, Sumiya Danurroeni,

Yogi Waskito Aji, Isnaini210-228

EFFECT OF CHIA SEED ADDITION AS AN ALTERNATIVE EGG SUBSTITUTE TO EXPANSION VOLUME IN SPONGE CAKE

Prima Wijayanti, Dini Nur Hakiki229-238

DESIGNING HAND WASHER SINK FOR PRIMARY STUDENT FROM ERGONOMIC PERSPECTIVE

Tony Wiguna, Triarti Saraswati, Aditya Tirta Pratama239-253

ACCEPTANCE OF INSECT AS FOOD: A REVIEW

Mohamad Rajih Radiansyah, Athiefah Fauziyyah254-263

THE LEVEL OF CONSUMER'S PREFERENCE TO PEPPER POWDER BASED ON THE PIPERINE COMPOUND

Muhamad Holi Widodo, Dini Nur Hakiki264-275

SUB THEME: BIODIVERSITY FOR SUSTAINABLE ENVIRONMENT

FISHERIES MANAGEMENT FOR SOCIETY 5.0 IN INDONESIA

Ernik Yuliana276-285

DEVELOPMENT OF CRISPR/CAS9 PLASMID FOR GENE EDITING OF EGFR_{vIII} GENE OF GLIOBLASTOMA MULTIFORME

Diki, Mutimanda Dwisatyadini, Wahyu Widowati,

Erv Afifah, Cintani Dewi Wahyuni, Jenifer Kiem Aviani ..286-290

TYPES OF MANGROVES WITH POTENTIAL AS MEDICINE
PLANTS IN MANGROVE VEGETATION AREA, BLANAKAN
DISTRICT, SUBANG, WEST JAVA

Mutimanda Dwisatyadini, Susi Sulistiana,

Ludivica Endang Setijorini291-308

THE COMPARISON OF THE POPULATION OF PLAIN AND
MIXED COLORED CATS IN JAKARTA AND PONTIANAK

Khintan Desiranti, Vera Veronica, Diki, Soraya Habibi309-314

ARRANGEMENT OF SLUM SETTLEMENT AREAS
IN KAMPUNG UTAN PANJANG INTO A LIVEABLE CITY
WITH A LAND-READJUSTMENT APPROACH

Nandia Nurhasanah, Aysfan Nandha Yulianti,

Zahra Aulia Syuhada, Raymond Leonard,

Inneke Agustin, Muhammad Alif Leksono,

Achmad Nuzulul Furqan, Didi Indrawan, Ake Wihadanto,

Erika Pradana Putri, Ulul Hidayah315-336

SEAWEED CULTIVATION SARGASSUM SP. USING
POCKET VERTICULTURE METHOD AT HIGH CURRENTS

Rinda Noviyanti337-355

IMPLEMENTATION OF THE PHILOSOPHY OF VALUE AND
LOCAL WISDOM OF THE SAKAI INDIGENOUS
COMMUNITY IN SUSTAINABLE DEVELOPMENT GOALS

Lina Asnamawati, Mery Berlian, Is Eka Herawati,

Timbul Rasoki, Ana Nurmalia356-374

BIOLOGICAL ASPECT OF HUMAN INTELLIGENCE:
ANATOMY, CELL BIOLOGY, AND MOLECULAR BIOLOGY

Fawzi R. Zuhairi, Sri Utami, Heny Kurniawati,

Mutimanda Dwisatyadini, Raflen Aril Gerungan375-407

ECTOPARASITE DIVERSITY AND ABUNDANCE IN
VANNAMEI SHRIMP (LITOPENAEUS VANNAMEI)

CATCHING OF FROM ESTUARIAN CILACAP CHILDREN
AS EARLY CONSERVATION EFFORT

Rokhmani, Kusbiyanto, Yosep Ditya Nugroho408-425

SPATIAL PLANNING INFORMATION SYSTEM IN
INDONESIA

Erika Pradana Putri426-435

STATISTICAL INFERENCE-BASED DECISION MAKING FOR SMALL AND MEDIUM-SIZED ENTERPRISE

Suparman,

*Student, Department of Statistics,
Universitas Terbuka, (INDONESIA)
alosuparman074@gmail.com*

Abstract

More than 22 millions Indonesians running Small and Medium-sized enterprise (UKM stands for Usaha Kecil dan Menengah), absorbed more than 43.9 millions workers and contributed more than Rp 1.6 trillions to Indonesia's Product Domestic Brutto (PDB)" (a citation from Sri Wahyuningsih, Lecturer, Universitas Wahid Hasyim, "PERANAN UKM DALAM PEREKONOMIAN INDONESIA", 2009). "The PKL" stands for Pedagang Kaki Lima (street vendor) selling foods, garment or other small sized commodities is the most popular example of the UKM and it has been chosen as the subject of this study. Survival and development of the UKM are indeed important to Indonesia's economy. One important issue among UKM is in decision making process about whether to stop the business or continue with/without needs for capex. Scientific approach making use of riel data and statistical inference can well be utilized for this purpose and produce reliable basis for a decision making. When cost of goods and selling price have been established and ensure profitability, the remaining question is about the plausible sales projection. Trial running the subject shop of this experiment for 35 days, generates sufficient variable random data of sales, visitors and other relevant information. Further, by making use of statistical inference theory, a reliable estimate of sales potential and other related data will be available for decision making. When the scientific-approached concept is developed among UKM individuals and becomes a culture, it will rectify the path toward enjoying the benefit of the forth coming Society 5.

Keywords: Street vendor, Scientific Approach, Variable random data, Statistical Inference, Society 5.0

1 INTRODUCTION

More than 22 million Indonesians running Small and Medium-sized enterprise, the UKM (Usaha Kecil dan Menengah), absorbed more than 43.9 million workers and contributed more than Rp 1.6 trillion to Indonesia's Product Domestic Brutto (PDB)", (a citation from S. Wahyuningsih, Lecturer Universitas Wahid Hasyim, "Peranan UKM Dalam Perekonomian Indonesia", (2009)) [1]. "PKL=Pedagang Kaki Lima" (street vendor) selling foods, garment or other small sized commodities is a popular example of this business entity and it has been chosen as the subject of this study

PKL is a label attached to those small-sized enterprises operating on roadsides or sidewalk/ pedestrian. They are one, yet most popular example of The UKM group, the Small and Medium-Sized Enterprise.

The purpose of this paper is to collect and analyze sales, customer's data of a PKL and precipitation forecast; additionally obtain also other related data about its operation. Eventually, based upon the statistics of data sample and its inference, a conclusion and basic argument for further steps of decision making related to survival or development if any of the PKL can be formulated.

2 METHODOLOGY

2.1 Subject of The Study

The PKL chosen for this study, located in an area at a busy main street in South Jakarta. It bears the name "Sate Maranggi 29", selling beef, chicken meat and skin 'sate', a typical Indonesian meat barbecue. This relatively new PKL, in operation for less than a month, planned to open 7 days a week starting 13.00 to 09.00 pm, employing two helping boys. It is equipped with visitors' facilities i.e. a semi-permanent plastic covered hood/tent, 2 two meters long tables and 10 chairs. I counted more than a dozen of PKL selling food nearby. Despite the PKL selling similar food quite limited, competition among them is tough. The owner of 'Sate Maranggi 29' explained that buyers prefer delicious taste, low price and acceptable size. Buyers are

mostly those travelling on the way home from their jobs, driving motor bikes. Take away order as well as on-line also offered to buyers.

The owner manages to formulate and produce the foods at a competitive price yet yielding the targeted maximum gross profit of 100 percent/profit margin of 50%.

He has been successful in finding the source of good quality raw materials especially the low price beef and finding a unique tasty recipe of the sauce for the barbecue. The remaining issue to be answered is its business prospect: Its survival or growth or else the other-way-round, bankrupt?

The entrepreneurs running UKM, according to the data published by BPS in 2006, 73% of them graduated from junior high school (SLTP) or lower, 21% from senior high school (SLTA), and only 6 % has a high education background (vocational diploma, bachelor or other university degree) [1].

In view of that, it is very probably that most UKM is managed in a traditional way, particularly in decision making process. I am tempted to take action by offering optional solution, especially the scientific-based one.

The subject being studied, 'Sate Maranggi 29' at the preliminary stage, employed 2 sale boys and paid allowance of Rp50,000/day/person plus free Rp25,000 lunch meal every day. Although this allowance is lower than the minimum regional remuneration requirement of Jakarta (UMR Jakarta 2021): Rp 4.416.186 [2], it is still acceptable because difficulty to find job.

According to BPS Publication (2006) in UKM sectors, 31.7 million out of 43.9 million workers (60%) are not paid, because they are families or the owner himself [1].

The success, failure or in another words the life of any trading business depends basically on whether in a certain period of time, a day, a week, a month or a year, it is capable of getting gain from the exchange between their goods or services they sold and the value in terms of money they collected.

Cash money in an UKM circulates very fast as owners will directly consume gain of their income to finance their daily living expenses. If they can get a picture about their business prospect early enough, they can make decision in time, of continuing the enterprise and make available any additional facilities or cut expenses if needed, or else to stop the current one to avoid any further loss and look for new option.

2.2 Design of Experiment

Pictures of the long period run (example 1 year) of an enterprise, which indicates among others it prospects, will be assumed as population. We can get the important and fairly accurate data and information about the population by running the enterprise in the intended duration. However, this method suffers from two disadvantages – long waiting time and costly. Both are not acceptable.

Thanks to the statistical sampling method and inference theory, the needs to collect all data from population which will be numerous in number can be avoided. To do the inference we take a representative sample, namely a sample which well represents the population. A sample which conforms to the requirement is the random sample fitting the homogenous population and be drawn randomly (not bias).[3]

2.2.1 *Data, Information and Sampling*

Scientific-based analysis will need two tools, the riel random data and the theoretical science: mathematics, statistics and the other ones which are neither statistics nor mathematics.

Our analysis concerned with inference—that is, reaching valid conclusion concerning the population on the basis of information from the sample. [3]

Sale in rupiah, number of buyers, climatic condition-precipitation/rain, and traffics (vehicle also people) are very probably the variables which correlated each other and constitute the variable vectors of the analyzed population. This study will cover only 3 variable vectors, namely:

Sale in rupiah (X_1),
 Number of buyer (X_2), and
 Precipitation data (X_3).

Sale data and number of guest are provided by the entrepreneur and precipitation data is taken from those published by <https://climate-data.org> [4].

Sample size between 30 and 50 is considered as large, and in multivariate case sample is large if $(n - p)$, wherein n =number of observations, p =number of variables) is large (30 - 50) [5]. When the sample is large, tests of hypotheses and confidence region for μ , the population mean, can be constructed without the assumption of normal population and inferences about μ are based on χ^2 [5]. This is the reason of drawing sample size 35. Thus, test for normal distribution of data is no needed.

2.2.2 Statistical Multivariate

The goal of our analysis is inference of the population means, namely to make a valid conclusion about the means of a population based on a sample. As we have $p \geq 1$ variables, multivariate statistical approach shall be used instead of univariate one. We analyze data jointly. Simultaneous analysis yields stronger test, with better error control. [6]

The values of the variables are all recorded for each distinct item, individual, or experimental unit. Accordingly, as this study sample size, $n = 35$ and variable, $p=3$, array of data can be displayed as follow [6]:

Table 1. Observed variable data

Variable, p	Sample, n					
1	X_{11}	X_{21}	X_{31}	X_{351}
2	X_{12}	X_{22}	X_{32}	X_{352}
3	X_{13}	X_{23}	X_{33}	X_{353}

And we can display these data in form of a matrix X_{jk} of p rows and n columns:

$$X_{jk} = \begin{bmatrix} X_{11} & X_{21} & \dots & X_{351} \\ X_{12} & X_{22} & \dots & X_{352} \\ X_{13} & X_{23} & \dots & X_{353} \end{bmatrix} \quad \begin{array}{l} j=1,2, \dots j=n=35 \\ k=1,2, k=p=3 \end{array}$$

The statistical methods designed to elicit information from those types of data sets and the main objective of this scientific investigation is *data/structural reduction, dependence among variables, prediction, hypothesis construction, and testing* [5]

A large data set is bulky and its very mass poses a serious obstacle to an attempt to visually extract pertinent information. By calculating certain summary numbers in accordance with descriptive statistics analysis, similar information can be obtained. Arithmetic average or sample mean is a central value, and the average of squares distances of all data from means provide measure of spread/variation. [7]

Mean of a sample can be computed from n data on each p variables, so that there will be p sample means [6]:

$$\bar{x}_k = \frac{1}{n} \sum_{j=1}^n x_{jk} \quad k=1,2,\dots,p \quad (1)$$

In our particular experiment, $n=35$, $p=3$. the vector mean of X :

$$\bar{X} = \begin{bmatrix} \bar{x}_1 = \frac{1}{35} \sum_{j=1}^n x_{j1} \\ \bar{x}_2 = \frac{1}{35} \sum_{j=1}^n x_{j2} \\ \bar{x}_3 = \frac{1}{35} \sum_{j=1}^n x_{j3} \end{bmatrix} \quad \begin{matrix} j=1,2, \dots, 35 \\ k=1,2,3 \end{matrix}$$

A measure of spread is provided by sample mean variance-covariance, for p variables and n observations it can be calculated by the following formulas [6]

$$s_k^2 = \frac{1}{n} \sum_{j=1}^n (x_{jk} - \bar{x}_k)^2 \quad k=1,2,\dots,p \quad (2)$$

$$s_{ik} = \frac{1}{n} \sum_{j=1}^n (x_{ji} - \bar{x}_i)(x_{jk} - \bar{x}_k) \quad i=1,2,\dots,p, \quad k=1,2,\dots,p \quad (3)$$

In our case, $n = 35$ and $p=3$

The variance covariance:

$$\begin{matrix} s_{11} = 1/35 \sum (x_{j1} - \bar{x}_1)^2 \\ s_{22} = 1/35 \sum (x_{j2} - \bar{x}_2)^2 \quad ; j = 1, 2, 3 \dots \dots 35 \\ s_{33} = 1/35 \sum (x_{j3} - \bar{x}_3)^2 \\ s_{12} = 1/35 \sum [(x_{j1} - \bar{x}_1)((x_{j2} - \bar{x}_2))] \\ s_{13} = 1/35 \sum [(x_{j1} - \bar{x}_1)((x_{j3} - \bar{x}_3))] \\ s_{23} = 1/35 \sum [(x_{j2} - \bar{x}_2)((x_{j3} - \bar{x}_3))] \end{matrix} \quad \Sigma = \begin{bmatrix} s_{11} & s_{12} & s_{13} \\ s_{21} & s_{22} & s_{23} \\ s_{31} & s_{32} & s_{33} \end{bmatrix}$$

In fact $s_{12} = s_{21}$; $s_{13} = s_{31}$; $s_{23} = s_{32}$

s_{11} , s_{22} , s_{33} are variants

s_{12} , s_{13} , s_{21} , s_{23} , s_{31} , s_{32} are covariants

If there is no particular association between two variables, covariants are approximately zero.

Final descriptive statistic is r , the sample correlation coefficient (Pearson's product-moment correlation coefficient), defined as follows [6]:

$$r_{ik} = \frac{S_{ik}}{\sqrt{S_{ii}} \sqrt{S_{kk}}} = \frac{\sum_{j=1}^n (X_{ji} - \bar{X}_i)(X_{jk} - \bar{X}_k)}{\sqrt{\sum_{j=1}^n (X_{ji} - \bar{X}_i)^2} \sqrt{\sum_{j=1}^n (X_{jk} - \bar{X}_k)^2}} \quad (4)$$

Value of r ranges from -1, 0, and +1 and it shows degree of correlation between two variables. 1 is the highest, - and + signs meaning increase of one variable will decrease the other (case -), and increase of one variable increasing also others (case +), and 0 means no correlation.

The summary of matrixes of the vector means, variance and correlation are as follow:

$$\bar{X} = \begin{bmatrix} \bar{X}_1 \\ \bar{X}_2 \\ \bar{X}_3 \end{bmatrix} \quad \Sigma = \begin{bmatrix} S_{11} & S_{12} & S_{13} \\ S_{21} & S_{22} & S_{23} \\ S_{31} & S_{32} & S_{33} \end{bmatrix} \quad R = \begin{bmatrix} 1 & r_{12} & r_{13} \\ r_{21} & 1 & r_{23} \\ r_{31} & r_{32} & 1 \end{bmatrix}$$

sample mean sample variance covariance sample correlation

Inferences about A Vector Mean of the Population.

Descriptive statistics provided us with 3 summary statistics, namely vector sample mean, matrix variance covariance, and matrix correlation.

Inference about vectors means of population based on sample data, is carried out by testing the null hypotheses:

$$H_0 : \mu = \mu_0 \quad \text{and} \quad H_1 : \mu \neq \mu_0$$

This test will affirm the plausability of μ_0 as a value for the population mean.

Since we are working with multivariate data, the proper test formula is the Hotteling T² formula [5]:

$$T^2 = (\bar{X} - \mu_0)' \left(\frac{1}{n} S \right)^{-1} (\bar{X} - \mu_0) = n(\bar{X} - \mu_0)' S^{-1} (\bar{X} - \mu_0) \quad (5)$$

Where [5]

$$\bar{x}_{(p \times 1)} = \frac{1}{n} \sum_{j=1}^n x_j, \quad S_{(\rho \times \rho)} = \frac{1}{n-1} \sum_{j=1}^n (x_j - \bar{x})(x_j - \bar{x})', \quad \text{and } \mu_0 (p \times 1) = \begin{bmatrix} \mu_{10} \\ \mu_{20} \\ \vdots \\ \mu_{p0} \end{bmatrix} \quad (6)$$

X = vector mean of respective variable; n= sample size; p= number of variable; S = variance –covariance; μ_0 = population means of respective variable.

Although we do not assume that data is a normal distribution [X_j not similar to Np (μ, Σ)]; we can still make inferences (hypotheses & make confidence statements) about population data since our sample size is large namely $n - (35 - p) = 32$ ($32 > 30$). However, instead of F distribution, the test should be based on Chi-square distribution, χ^2_p . [5]

$$T^2 \approx \chi^2_p \quad (\text{as } n \rightarrow \infty, (n-1)p/(n-p) F_p, n-p \rightarrow \chi^2_p) \quad (7)$$

Let x_1, x_2, \dots, x_n be random sample from a population mean μ and positive definitive covariance matrix Σ . When $(n - p)$ is large (≥ 30), the hypotheses $H_0: \mu = \mu_0$ is rejected in favour of $H_1: \mu \neq \mu_0$, at level of significance approximately α , if the observed. [5]

$$n(\bar{x} - \mu_0)' S^{-1} (\bar{x} - \mu_0) > \chi^2_p(\alpha) \quad (8)$$

Where in for $n=35$, $p=3$, $\alpha = 0.05$ from table Chi Square:

$$\chi^2_3 (0.05) = 7.81 [3]$$

Then, in our case, rejection criteria is:

$$35(\bar{x}_1 - \mu_1 \quad \bar{x}_2 - \mu_2 \quad \bar{x}_3 - \mu_3) \begin{bmatrix} s_{11} & s_{12} & s_{13} \\ s_{21} & s_{22} & s_{23} \\ s_{31} & s_{32} & s_{33} \end{bmatrix}^{-1} \begin{bmatrix} \bar{x}_1 - \mu_1 \\ \bar{x}_2 - \mu_2 \\ \bar{x}_3 - \mu_3 \end{bmatrix} > \chi^2(0.05) = 7.81 \quad (9)$$

The plausible means region is [5]:

$$\begin{aligned} \bar{x}_1 \pm \sqrt{\chi_p^2(\alpha)} \sqrt{\frac{s_{11}}{n}} & \text{ contains } \mu_1 \\ & \vdots \\ \bar{x}_p \pm \sqrt{\chi_p^2(\alpha)} \sqrt{\frac{s_{pp}}{n}} & \text{ contains } \mu_p \end{aligned} \quad (10)$$

And for $n=35$, $p=3$, $\alpha = 0.05$, $\chi^2_3 (0.05) = 7.81$, the region of

$$\begin{aligned} \mu_1 & \text{ is } \bar{x}_1 \pm \sqrt{(7.81)} \sqrt{[(s_{11})/35]} ; \mu_2 & \text{ is } \bar{x}_2 \pm \sqrt{(7.81)} \sqrt{[(s_{22})/35]} ; \mu_3 & \text{ is } \\ \bar{x}_3 & \pm \sqrt{[(7.81)]} \sqrt{[(s_{33})/35]} \end{aligned} \quad (11)$$

3 RESULTS

3.1 Observed Sample Data and Data Matrix

Table 2. Sale Data in Thousand Rupiah

411	735	332	299	659	261	170
74	185	379	222	165	318	254
338	182	92	133	171	286	173
181	437	177	660	572	260	324
199	150	240	256	679	739	517

Table 3. Number of Customer

9	15	11	7	18	3	6
3	7	8	6	3	10	7
9	8	5	7	7	5	6
6	15	8	8	11	8	8
6	5	5	4	6	8	11

Table 4. Precipitation Data/Rainfall, in mm

1.4	2.1	1.9	1.4	1.3	1.2	0.7
0.9	1.4	1.7	2.1	2	2.3	2
1.6	2	1.5	0.9	1.2	1.2	1.9
1.6	2.2	2.5	1.7	2	2.5	1.7
2	1.9	1.5	2	1.9	2.3	1.9

Vectors of Observed Data Matrix_X

$$X = \begin{bmatrix} 411 & 735 & 332 & 299 & 659 & 261 & 170 & 74 & 185 & 379 & 222 & 165 & 318 & 254 & 338 \\ 182 & 92 & 133 & \underline{171} & 286 & 173 & 181 & 437 & 177 & 660 & 572 & 260 & 324 & 199 & 150 \\ 240 & 256 & 679 & \underline{739} & 517 & & & & & & & & & & & \\ \\ 9 & 15 & 11 & 7 & 18 & 3 & 6 & 3 & 7 & 8 & 6 & 3 & 10 & 7 & 9 \\ 8 & 5 & 7 & \underline{7} & \underline{5} & 6 & 6 & 15 & 8 & 8 & 11 & 8 & 8 & 6 & 5 \\ 5 & 4 & 6 & 8 & 11 & & & & & & & & & & \\ \\ 1.4 & 2.1 & 1.9 & 1.4 & 1.3 & 1.2 & 0.7 & 0.9 & \underline{1.4} & 1.7 & 2. & 2. & 2.3 & 2 & 1.6 \\ 2 & 1.5 & 0.9 & 1.2 & 1.2 & 1.9 & 1.6 & 2.2 & \underline{2.5} & 1.7 & 2 & 2.5 & 1.7 & 2 & 1.9 \\ 1.5 & 2 & 1.9 & 2.3 & 1.9 & & & & & & & & & & \end{bmatrix}$$

3.2 Summary of Descriptive Statistics and Profit Forecast

The aforementioned formulas (1) to (10) are used to compute the followings:

Matrixes of the vector means, variance and correlation are:

$$\bar{X} = \begin{bmatrix} 409 \\ 10 \\ 1.7 \end{bmatrix} \quad \Sigma = \begin{bmatrix} 42824.4 & 599.8 & 20.9 \\ 599.8 & 16.3 & 0.3 \\ 20.9 & 0.3 & 0.2 \end{bmatrix} \quad R = \begin{bmatrix} 1 & 0.72 & 0.23 \\ 0.72 & 1 & 0.18 \\ 0.23 & 0.18 & 1 \end{bmatrix}$$

sample mean sample variance covariance sample correlation

To check the region of each variables mean we use the Formula (10). The result are summarized in *Table 5*, and it shows also the correlation between two variables.

Table 5. Statistics Descriptive

No.	item	Variable, p					
		X ₁	X ₂	X ₃			
1	Vector Mean	509	10	1.7			
2	Vector Mean, min	311	8	1.5			
3	Vector Mean,max	507	12	1.9			
4	Correlation				X ₁ - X ₂	X ₁ - X ₃	X ₂ - X ₃
					0.72	0.23	0.18

Table 6. Profit Forecast, (in Rupiah)

No	Item	Daily	Monthly (25 days)	Annually (12months)
1	Sale, average	409,000	10.225.000	122.700.000
2	Gross profit margin, 50%	204,500	5.112.500	61.350.000
3	Sales cost (*)	To be decided		
4	Utilities			
4.1	Investment Rp 2.400.000	4.000	100,000	1,200,000
4.2	(Depreciation, 24 months) Water, electricity, etc.	1.200	30,000	360,000
5	Gross Profit (2 – 4)	199.300	4.982.500	59.790.000

* Sale cost needs be decided later by the owner which will depend on recruitment of the sales force. The cost will reduce the profit.

3.3 Discussion

1. At running operation of 25 days/month, this business offers a potency monthly profit of Rp 4.982.500 (average), which is slightly above the standard Jakarta regional living cost (UMR Jakarta 2021) of Rp 4.416.186. per month [2] and therefore worth to be continued.
2. The owner shall decide how many sales force to be recruited and at what cost be paid. The cost will diminish his earning.
3. Numbers of current available chairs is the same as mean of customer and together with all other facilities considered to be kept or else added two more chairs as anticipation.
4. A relatively high correlation ($R = 0.72$) between sale and number of customers; on-line marketing and circulating brochures can help inviting the interest of more customers.
5. Precipitation variable correlates very low with both sale and number of customer. The reason is probably due to the fact that this study covered only the dry season period. The study in wet season may give different result.
6. This study is only the beginning. In the future other experiment can be conducted studying effect of other variables such as traffics, differences between week day and week end, new recipe or new foods and drinks. Since multiplying earnings for this enterprise will only be effectively done by opening new outlets, the same new experiment will work in providing basis for decision.

Big Data with its 3Vs feature – Big Volume, very high Variability, and immense Velocity, capable of processing data at any format in in addition to storage and retrieval, in real time. [8]

Society 5.0 according to one definition: "A human-centered society that balances economic advancement with the resolution of social problems by a system that highly integrates cyberspace and physical space" and Big Data is a part of it. [9].

We expect therefore when Society 5.0 is around, it will provide services to anybody, at affordable cost, real time, to process and analyze data and information to generate the required answer for solution.

That is the situation wherein PKLs can enjoy the benefit of the coming Society 5.0 and Big Data, as the latter can provide inputs for PKLs decision making in real time. By merely upload the required data any time and in any format, Big data will take care the manipulation of data and generate the solution for decision making.

4 CONCLUSIONS

This study has provided its subject – Sate Maranggi 29 with a set of arguments for decision making based on a scientific approached. This PKL according to this statistical analysis, in the long run offers an estimated mean income Rp199.300 daily/Rp 4.982.500 monthly/Rp59.790.000 annually, provided all of the sale-related variables remains similar and it operates 25 days a month, 12 months a year. The monthly average net profit namely the monthly income of the owner, is well above minimum living cost limit, thus the business worth to be run. The owner has to decide himself concerning number and salary of sale person in view of the tolerated reduction of his monthly earning. Only minor adjustment needed in view of equipment to entertain the customers.

If the owner intend to develop the business still further to achieve higher gain, multiple to the maximum existing mean sale, the proper strategy is to open other similar enterprise at other location (outlet).

This study has to be considered as the beginning/preliminary introduction of the technic. Some others such as difference between week day and week end, recipe changes, new food and drink menu, can be run in accordance with the needs but similar in process to this experiment.

Introduction and developing familiarity about scientific-based decision making among small and medium-sized enterprises will provide them with a plausible technic in making policy, strategy and

forecasting their businesses. The success of this process will rectify a pavement for small and medium-sized enterprises to enjoy the benefit from the coming Society 5.0 and Big Data.

ACKNOWLEDGEMENTS

Special thanks is due to Mr Rizky Jatnika, owner of the 'Sate Maranggi 29' for his collaboration and supplying data/information.

REFERENCES

- [1] Sri Wahyuningsih, "Peranan UKM dalam Perekonomian Indonesia", Semarang, Indonesia, Fakultas Pertanian, Wahid Hasyim University, 2009, Retrieval 2021.
- [2] Rincian UMR Jakarta 2021 dan Daerah Sekitarnya, Kompas.com - 29/03/2021, Retrieval 2021.
- [3] Sri H. Kartiko and Suryo Guritno, "Metode Statistika Multivariat", Edisi 1, Jakarta, UT University, 2008.
- [4] PONDOK PINANG WEATHER IN AUGUST and SEPTEMBER// WEATHER AVERAGES, <https://climate-data.org>, Retrieval 2021.
- [5] Carolyn J. Anderson, "Inferences About a Mean Vector", Illinois, USA, Department of Educational Psychology, University of Illinois, 2017, Retrieval 2021.
- [6] T. W. Anderson, "An Introduction To Multivariate Statistical Analysis", Third Edition, Stanford CA, Stanford University, Department of Statistics, John Wiley & Sons, Inc., 2003, Retrieval 2021.
- [7] Richard A. Johnson and Dean W Wichern, "Applied Multivariate Statistical Analysis, Sixth Edition, New Jersey, USA, Pearson Prentice Hall, 2007, Retrieval 2021.
- [8] Big data, Wikipedia, the free encyclopedia, Retrieval 2021.
- [9] Achieving Society 5.0, <https://www8.cao.go.jp> > cstp > english > society5_0, Retrieval 2021.

IMPLEMENTATION K-MEDOIDS ALGORITHM FOR DISTRIBUTION MAPPING OF COVID-19 IN SURABAYA

Vivi Mentari Dewi¹, Iis Dewi Ratih²

*^{1,2} Faculty of Vocational, Institut Teknologi Sepuluh Nopember,
Surabaya, (INDONESIA)
vivimentari9@gmail.com*

Abstract

Surabaya was recorded as the city with the highest active Covid-19 in East Java with 225 cases based on data released by the East Java Province on March 1st, 2021. One step to minimizing the increase of cases is by grouping regions based on the number of existing cases. The previous mapping only displayed data on the status of confirmed patients in each region which was updated daily. So in this research, a mapping of urban villages in Surabaya was carried out which would be included in the cluster based on confirmed cases in treatment, confirmation of recovery, and confirmation of death using the algorithm K-Medoids. K-Medoids is a clustering algorithm (unsupervised learning) in machine learning, the development of K-Means which is sensitive to outliers. K-Medoids has better clustering performance for large datasets. The results of the analysis showed that the urban villages with the highest number of deaths were Karah and Kutisari with 3 cases. The results of clustering using K-Medoids with an evaluation value of the Davies-Bouldin Index (DBI) of 0.5666 obtained the optimum cluster of 4 clusters. Cluster 1 (confirmed cases of high death) 35 urban villages, clusters 2 and 3 (confirmed cases under treatment, confirmed cases recovered, and confirmed cases of low death) 56 and 49 urban villages, and cluster 4 (confirmed cases under treatment and confirmed cases recovered high) 14 urban villages. Keywords: Covid-19, Davies-Bouldin Index (DBI), K-Medoids, Machine Learning, Unsupervised Learning

1 INTRODUCTION

Coronavirus Disease 2019 (Covid-19) is a new type of virus that can be transmitted through direct or indirect contact with infected people, surfaces or objects used. Covid-19 cases are spread in all provinces, one of which is East Java, where Surabaya is the capital with the highest active Covid-19 cases in East Java, referring to data released by East Java Province on March 1st, 2021 with 225 active cases (Ulum, 2021). Extra handling is needed to minimize the increase in Covid-19 cases, especially in Surabaya. Steps that can be taken to control the increase in cases are by grouping areas based on existing data. Several studies have conducted clustering of Covid-19 cases in Indonesia (Sindi et al., 2020), but further analysis is needed because there is no research on mapping the distribution of Covid-19 cases in urban villages in Surabaya. The previous mapping on the Surabaya Respond Covid web page only displayed data on the status of confirmed patients in each region which was updated every day. So this research needs to be done to get more detailed information through the formed urban village clusters, as well as to facilitate handling by looking at the characteristics of confirmed cases in treatment, confirmation of recovery, and confirmation of death in each cluster using the clustering method, namely K-Medoids Algorithm. The K-Medoids Algorithm is one of the methods in data mining that is popular among researchers. K-Medoids is one of the clustering algorithms included in machine learning thegroup unsupervised learning which is used to group data into several clusters, where the data is not classed first and then grouped. According to Chrisnanto and Abdillah (2015), the K-Means algorithm is more efficient for smaller data sets, while K-Medoids has better performance for large datasets and K-Medoids also has better performance when compared to K-Means. In addition, according to Kamila, Khairunnisa, and Mustakim (2019) K-Medoids is a development of the K-Means algorithm which is sensitive to outliers in clustering. Research using K-Medoids has been carried out, the results show that themethod K-Medoids is better than K-Means method because the results of the

cluster formed by K-Medoids are more homogeneous than K-Means (Sangga, 2018). In addition, the results of the cluster formed using K-Medoids show a higher validity value than the method K-Means (Marlina et al., 2018). The benefits obtained after conducting this research are getting urban clusters based on cases in treatment, recovery, and death using a more effective and efficient method, namely K-Medoids Algorithm. The results of the cluster formed are distinguished from urban villages based on Covid-19 cases, then evaluated using the Davies-Bouldin Index (DBI) where the method uses the value of cohesion (closeness of data to centroids in a cluster) and separation (distance between centroids and objects in other clusters) (Sundar, Chitradevi, and Geetharamani, 2012). The optimum clusters obtained are in the form of homogeneous villages in one cluster and heterogeneous between clusters, then visualized through mapping and characteristics of confirmed cases in treatment, confirmation of recovery, and confirmation of death based on clusters formed to determine the potential spread of Covid-19 cases in villages in each cluster.

2 METHODOLOGY

The research methodology used in this study is described as follows.

2.1 Data Source

The data used in this study is secondary data obtained from the Surabaya Response Covid-19 website (<https://lawancovid-19.surabaya.go.id/>). The data is data that is *updated* every day regarding the addition and reduction of cases by taking data for March 2021 in 154 urban villages in the city of Surabaya.

2.2 Variables

Variabel in the form of a dataset on the number of Covid-19 cases that used in this research described in Table 1 below.

*Table 1. Data Structure of Covid-19 Cases
for each Urban Villages in Surabaya.*

Number of Urban Villages	X_1	X_2	X_3
1	$X_{1.1}$	$X_{1.2}$	$X_{1.3}$
2	$X_{2.1}$	$X_{2.2}$	$X_{2.3}$
3	$X_{3.1}$	$X_{3.2}$	$X_{3.3}$
\vdots	\vdots	\vdots	\vdots
154	$X_{154.1}$	$X_{154.2}$	$X_{154.3}$

The operational definition for each research variable based on the Decree of the Minister of Health Number HK.01.07/Menkes/247/2020 concerning Guidelines for the Prevention and Control of Covid-19 is explained as follows.

- Under treatment case or confirmation (X_1) is defined as a person who is tested positive for Covid-19 as evidenced by an RT-PCR laboratory examination that requires hospitalization.
- Recovered case (X_2) is defined as a person who has been treated and is declared clean from Covid-19 infection as evidenced by an RT-PCR laboratory examination.
- Death case (X_3) is defined as a confirmed person in Covid-19 treatment who dies.

2.3 Analysis Step

The explanation for each research variable is explained as follows.

- Determine the number of k clusters
- Select objects k randomly as medoids
- Calculate the distance of non-medoids with the medoids initialon all variables using euclidean distance
- Put non-medoids objects in the cluster with the minimum distance
- Calculate the total cost initial
- Repeat steps 2 to 5 until aobtained total cost is new

- g) Calculate the difference among the total cost of the new totalcost initial If $S < 0$ repeat steps 2 to 7, but stop if $S > 0$
- h) Evaluating the results of the cluster is formed using the Davies-Bouldin Index (DBI)

3 RESULTS

Result of clustering the number of Covid-19 cases of urban villages in Surabaya using K-Medoids Algorithm described below.

3.1 K-Medoids Algorithm

3.1.1 Cluster Center

The cluster center shows the initial medoids for each variable in a cluster described in Table 2 below.

Table 2. Initial Cluster Center.

Variables	Cluster			
	1	2	3	4
Confirmed Case of Under Treatment (X_1)	14	3	8	24
Confirmed Case of Recovered (X_2)	13	3	8	24
Confirmed Case of Death (X_3)	0	0	0	0

The cluster center or medoids is a cluster representative point, where the number of clusters formed using K-Medoids algorithm is 4 clusters. The urban villages selected as medoids are Sawunggaling, Kapasari, Made, and Babatan. Medoids in the first cluster is Sawunggaling Urban Village by the number of confirmed cases of under treatment at 14, confirmed cases of recovered at 13, and confirmed cases of death at 0. Medoids in the second cluster is Kapasari Urban Village by the number of confirmed cases of under treatment at 3, confirmed cases of recovered at 3, and confirmed cases of death at 0. Medoids in the third cluster is Made Urban Village by the number of confirmed cases of under treatment at 8, confirmed cases of recovered at 8, and confirmed cases of death at 0. Medoids in the fourth cluster is Babatan Urban Village by the number of confirmed cases of under treatment at 24, confirmed cases of recovered at 25, and confirmed cases of death at 0.

3.1.2 Member of Cluster

Member of Clustering using K-Medoids Algorithm described in Table 3 below.

Table 3. Member of Cluster.

Klaster	Number of Cluster Member
1	35
2	56
3	49
4	14

The results of clustering using K-Medoids algorithm were found in cluster 1 as many as 35 urban villages, in cluster 2 as many as 56 urban villages, in cluster 3 as many as 49 urban villages, and in cluster 4 as many as 14 urban villages.

3.2 Davies-Bouldin Index (DBI)

Davies-Bouldin Index (DBI) is an internal evaluation used to determine the most optimal number of clusters of clustering using K-Medoids algorithm that described in Table 4 below.

Table 4. Davies-Bouldin Index (DBI).

Number of Cluster	DBI
3	0.8082

Table 5. Davies-Bouldin Index (DBI) (Continuation).

Number of Cluster	DBI
4	0.5666
5	0.5896

Value of Davies-Bouldin Index (DBI) by using the number of clusters as much as 3 to 5, in which the clusters formed said the optimum cluster if the DBI value is positive and close to zero. So it can be concluded that the optimum number of clusters for K-Medoids algorithm using of 4 clusters with a DBI value of 0.5666.

3.3 Mapping for Cluster Result of K-Medoids

Visualization of clustering the number of Covid-19 cases of urban villages in Surabaya using K-Medoids Algorithm described in Figure 1 below.

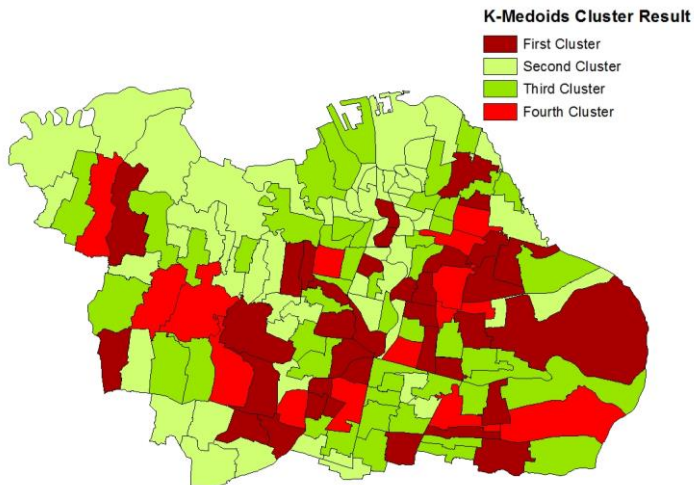

Figure 1. Mapping of K-Medoids.

Description for 4 cluster using boxplot to find out the character of each cluster according to confirmed cases under treatment, confirmed cases recovered, and confirmed cases died described in Figure 2 below.

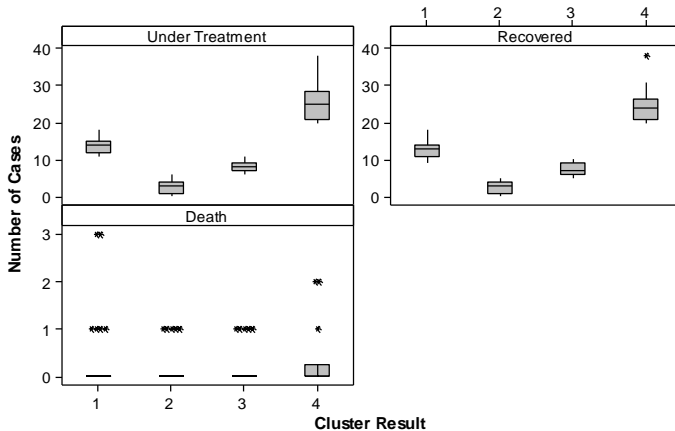

Figure 2. Boxplot of Covid-19 Cases Cluster Result.

The boxplot of cluster results using K-Medoids algorithm shows that there are 4 clusters formed with a large diversity of data on confirmed cases in treatment, confirmed cases recovered, confirmed cases died in the fourth cluster is quite large. This can be shown through the width of the boxplot in each cluster which is quite different. Moreover, the fourth cluster has a width boxplot that is very different from other clusters, where based on the boxplot it can be seen that the fourth cluster is an urban village with high Covid-19 cases by looking at confirmed cases in treatment and confirmed cases recovering. While the 1st cluster is a urban village with high confirmed cases of death. The second and third clusters are urban village with a low number of confirmed cases under treatment, confirmed cases recovered, and confirmed cases death. Considering that the first dan fourth clusters are areas with high Covid-19 cases, the Surabaya City Government should focus more on handling urban villages in these clusters in order to minimize the increase in Covid-19 cases, especially confirmed cases in treatment and confirmed cases of death.

4 CONCLUSIONS

The results of the clustering using *K-Medoids* algorithm and cluster evaluation with a DBI of 0.5666 obtained the optimum cluster formed as many as 4 clusters, where members in cluster 1 (urban villages with confirmed cases of high mortality) were 35 urban villages, in cluster 2 (urban villages with the number of confirmed cases under treatment, confirmed cases recovered, and confirmed cases of low death) as many as 56 urban villages, in cluster 3 (urban villages with confirmed cases under treatment, confirmed cases recovered, and confirmed cases low death) as many as 49 urban villages, and in cluster 4 (urban villages with confirmed confirmed cases of high under treatment and confirmed cases recovery) as many as 14 urban villages.

ACKNOWLEDGEMENTS

Thanks to my self for doing all this hard work and never quitting, also my lecturer in Business Statistics Department, Institut Teknologi Sepuluh Nopember who has guide author during preparation of this paper.

REFERENCES

- [1] Ulum, M. (2021) 'Covid-19 cases in Surabaya are again the highest in East Java', *Bisnis.com*, 2nd March. Available at: <https://surabaya.bisnis.com/read/20210302/531/1362583/case-covid-19-di-surabaya-re-tertinggi-di-jawa-timur>.
- [2] Sindi, S., Ningse WRO, Sihombing, IA, Ilmi, F., and Hartama, D. (2020) 'K-Medoids Clustering Algorithm Analysis in Grouping the Spread of Covid-19 in Indonesia', *Jti (Journal of Information Technology)*, 4(1), pp. 166–173.
- [3] Chrisnanto, YH and Abdillah, G. (2015) 'Application of Partitioning Around Medoids (PAM) Clustering Algorithm to See an Overview of Capabilities', *National Seminar on Information and Communication Technology*, 2015(Sentika), pp. 444–448.

- [4] Kamila, I., Khairunnisa, U., and Mustakim, M. (2019) 'Comparison of K-Means and K-Medoids Algorithms for Grouping Loading and Unloading Transaction Data in Riau Province', *Scientific Journal of Engineering and Management of Information Systems*, 5(1), p. 119. doi:10.24014/rmsi.v5i1.7381.
- [5] Sangga, VAP (2018) 'Comparison of the K-Means Algorithm and the K-Medoids Algorithm in Grouping Livestock Commodities in Central Java Province in 2015', Project *Final of Statistics Department, Faculty of Mathematics and Natural Sciences, Islamic University of Indonesia Yogyakarta*, 53(9), pp . 1689–1699.
- [6] Marlina, D., Putri, NF, Fernando, A., and Ramadan, A. (2018) 'Implementation of K-Medoids and K-Means Algorithms for Grouping of Disability Distribution Areas in Children', *Journal of CoreIT: Journal of Computer Science and Information Technology Research Results*, 4(2), p. 64. doi:10.24014/coreit.v4i2.4498.
- [7] Sundar, C., Chitradevi, M., and Geetharamani, G. (2012) 'AN ANALYSIS ON THE PERFORMANCE OF K-MEANS CLUSTERING ALGORITHM FOR CARDIOTOCOGRAM DATA CLUSTERING', *International Journal on Computational Sciences & Applications (IJCSA)*, 2, pp . 11–20.
- [8] Ministry of Health RI (2020) 'Decree of the Minister of Health of the Republic of Indonesia Number HK.01.07/MenKes/413/2020 concerning Guidelines for Prevention and Control of Corona Virus Disease 2019 (Covid-19)', *MenKes/413/2020*, 2019, pp. 1–207. Available at:
<https://covid19.go.id/storage/app/media/Regulation/KMK>
No. HK.01.07-MENKES-413-2020 on Guidelines for Prevention and Control of COVID-19.pdf.

***N*-SOFT SETS: LITERATURE REVIEW AND RESEARCH POTENTIAL**

Fatia Fatimah

Department of Mathematics, Universitas Terbuka, (INDONESIA)
fatia@ecampus.ut.ac.id

Abstract

N-soft sets have attracted many researchers rapidly. This paper presents a systematic literature review to provide the state of the art of *N*-soft sets. Scope for further research potential using *N*-soft sets and their extensions in decision-making problems is also explained. Keywords: *N*-Soft Sets, Literature Review, Research Potential, Decision-Making

1 INTRODUCTION

Real-world problems are complex. Therefore, these problems need to consider uncertainties whose handling is vital for obtaining fairish solutions. Uncertainty can be incomplete data, indistinguishability situations, randomness, fuzziness, and soft sets.

We focus on soft sets theory [1] that allows all parameters such as numbers, words, sentences, and functions. Thus, a soft set relates the parameters or attributes with information about the elements in the universe. This theory has been extensively applied in many different areas to manage uncertainty. Some of the recent soft set applications are as follows: in coding theory [2], smartphone selection [3], artificial neural network [4], credit scoring [5], context-aware video recommender systems using soft-rough set [6], social network analysis [7], movie selection [8].

Nowadays, we often face ratings in real-world situations, and decision-making based on that becomes significant. Nevertheless, soft set presents limitations to dealing with ranking or rating systems in non-binary evaluations. Fatimah et al. [9] introduced the concept of

N -soft set as the novel idea of a parameterized description of the universe of objects that depends on a finite number of ordered grades.

This paper aims to provide an outline of the N -soft set, its various extensions, its operations and to give a perspective to the research community about the potential of N -soft set theory in different fields. The rest of this paper is systematized: Section 2 introduces the concept of N -soft set, some basic operators, and extensions of N -soft set. Section 3 points out the trends and directions of the N -soft set context, and finally, the paper is concluded in Section 4.

2 N -SOFT SETS: LITERATURE REVIEW

Fatimah et al. [9] have illustrated N -soft set main features with real examples, and they have investigated its essential properties and fundamental operations, plus its relationships with existing models.

2.1 N -Soft Sets: Concepts and Basic Operations

This subsection wraps up the concept and basic operations of the N -soft set. The formal definitions are as follows:

Definition 1 [9]. Let U imply the universe of objects under consideration and E the set of attributes, $A \subseteq E$. Let $R = \{0, 1, 2, \dots, N-1\}$ be the set of ordered grades where $N \in \{2, 3, \dots\}$. A triple (F, A, N) is called an N -soft set on U if F is mapping from A to $2^{U \times R}$, with the characteristic that for each $a \in A$ and $u \in U$ there exists a particular $(u, r_a) \in U \times R$ such that $(u, r_a) \in F(a)$, $r_a \in R$.

The interpretation of the pair $(u, r_a) \in F(a)$, is that the element u belongs to the set of a -approximations of the set U with the grade r_a . The N -soft set tabular representation is recalled in Table 1.

Table 1. *N*-Soft Set.

(F, A, N)	a_1	a_2	...	a_q
u_1	$\{r_{11}\}$	$\{r_{12}\}$...	$\{r_{1q}\}$
u_2	$\{r_{21}\}$	$\{r_{22}\}$...	$\{r_{2q}\}$
...
u_p	$\{r_{p1}\}$	$\{r_{p2}\}$...	$\{r_{pq}\}$

Incredibly, this definition of *N*-soft set (Definition 1) is suitable and flexible to decision making, when experts must assess a set of alternatives based on various types of uncertainty attributes. In the first paper of *N*-soft set, Fatimah et al. [9] initially introduced several basic definitions and operations to deal with *N*-soft set. We mention some of them in this paper.

Definition 2 [9]. Define (F^0, Q, N) the normalized *N*-soft set from (F, A, N) , by the expression: for all $a_i \in A$, $u_i \in U$, $F^0(a_j)(u_i) = F(a_j)(u_i) - m$, where $m = \min r_{ij}$ in the tabular representation of the original (F, A, N) and $Q = \{1, 2, \dots, q\}$.

Definition 3 [9]. Two *N*-soft sets (F_1, A_1, N_1) and (F_2, A_2, N_2) are equal over the same universal U , $(F_1, A_1, N_1) = (F_2, A_2, N_2)$, if and only if $F_1 = F_2$, $A_1 = A_2$, and $N_1 = N_2$.

Definition 4 [9]. Two *N*-soft sets (F, A_1, N) and (G, A_2, N) on U are equivalent under normalization if $(F^0, Q_1, N) = (G^0, Q_2, N)$.

Definition 5 [9]. A weak complement of the *N*-soft set (F, A, N) is any *N*-soft set, (F^c, A, N) , where $F^c(a) \cap$

$$F(a) = \emptyset, \text{ for each } a \in A.$$

In tabular form, the weak complement acquires from any table with the same universe and set of attributes, where the number in each cell is always distinct from the number in the suitable cell of the genuine tabular representation.

2.2 Extensions of *N*-Soft Sets

In the last few years, the development of hybrid models of uncertain knowledge has been snowballing. Table 2 confirms the interest of many researchers in hybridization *N*-soft sets (NSS). They

are fuzzy N -soft sets [10], hesitant N -soft sets [11], hesitant fuzzy N -soft sets [12], interval-valued hesitant fuzzy N -soft sets [13], N -soft set approach to rough sets [14], intuitionistic fuzzy N -soft rough sets [15], N -soft topology [16], multi hesitant N -soft sets [17], neutrosophic N -soft sets [18], generalized vague N -soft sets [19], neutrosophic vague N -soft sets [20], Pythagorean fuzzy N -soft sets [21], complex fuzzy N -soft sets [22], complex Pythagorean fuzzy N -soft sets [23], complex spherical fuzzy N -soft sets [24], complex single-valued neutrosophic N -soft set [25], picture fuzzy N -soft sets [26], M -parameterized N -soft topology based on Technique for Order of Preference by Similarity to Ideal Solution (TOPSIS) approach [27], N -soft rough sets [28], Multi (Q, N) -soft multi granulation rough sets [29], and multi-fuzzy N -soft set [30].

Let us dwell on that N -soft sets advances. Fuzzy N -soft sets [10] is a hybrid model that combines fuzzy set theory with N -soft sets. Hesitant N -soft sets are a fusion of N -soft sets and hesitancy [11]. Hesitant fuzzy N -soft sets are a mix of hesitant fuzzy set theory with N -soft sets [12]. Interval-valued hesitant fuzzy N -soft sets blend of N -soft sets and interval-valued hesitant fuzzy sets [13]. The corresponding structures between N -soft sets and rough structures of various types N -soft sets are proposed by Alcantud et al. [14]. Akram et al. [15] introduced intuitionistic fuzzy N -soft sets, N -soft rough intuitionistic fuzzy sets, and also intuitionistic fuzzy N -soft rough sets. The N -soft topology consists of N -soft interior, N -soft exterior, N -soft closure, N -soft basis, N -soft frontier, and their related results [16].

N -soft set research development in 2020 as follows. Fatimah proposed multi hesitant N -soft sets [17] as a form of expansion of N -soft sets needed to represent multiple opinions from various respondents for multiple criteria and decisions. Neutrosophic N -soft sets as a hybrid model of neutrosophic sets and N -soft sets [18]. Generalized vague N -soft sets is a suitable combination of generalized vague soft sets with N -soft sets [19]. Neutrosophic vague N -soft sets are composed of neutrosophic vague sets and N -soft sets [20]. Pythagorean fuzzy N -soft sets as an integrating Pythagorean fuzzy set with N -soft set [21].

In 2021, N -soft set research is still growing. Complex fuzzy N -soft sets combine CFSs with N -SSs to handle the complex data in decision-making [22]. Complex Pythagorean fuzzy N -soft sets are the fusion of complex PFS theory with N -soft sets [23]. Complex spherical fuzzy N -soft sets describe parameterized information and ordinal ranking systems [24]. Complex single-valued neutrosophic N -soft set combines the 2-dimensional single-valued neutrosophic nature of the attributes with parameterized ordered grades [25]. Picture fuzzy N -soft set is a generalization of picture fuzzy sets (PFSs) and N -soft sets (N -SS) by observing that one of the essential concepts of neutral grade is missing in intuitionistic fuzzy N -SS (IFN-SS) theory [26]. M -parameterized N -soft topology based on the TOPSIS approach is proposed to deal with the actual situation in life when the grading/rating of both parameters and alternatives [27]. N -soft rough sets as a combination of rough sets and N -soft sets [28]. Multi (Q, N) -soft sets, multi (Q, N) -soft rough sets, and multi (Q, N) -soft multi-granulation rough sets [29]. Fatimah and Alcantud [30] proposed a new model that enhances multi-fuzzy set theory with the N -soft sets called multi-fuzzy N -soft set.

Table 2. Extensions of N -Soft Sets.

Year	Proposed model	Conclusion/Algorithm	Authors
2018	FNSS	<ol style="list-style-type: none"> 1. The algorithm of choice values of (F, N)-soft sets. 2. The algorithm of R-choice values of (F, N)-soft sets. 3. The algorithm comparison table of (F, N)-soft sets. 	[10]
2019	HNSS	<ol style="list-style-type: none"> 1. The algorithm of choice values of HNSSs. 2. The algorithm of weighted choice values of HNSSs. 	[11]

Year	Proposed model	Conclusion/Algorithm	Authors
		<ol style="list-style-type: none"> 3. The algorithm of choice values for arithmetic scores of HNSSs. 4. The algorithm of weighted choice values for arithmetic scores of HNSSs. 	
	HFNSS	<ol style="list-style-type: none"> 1. The algorithm of TOPSIS method based on HFNSS 2. The algorithm of the choice value of HFNSS 3. The algorithm of the L-choice value of HFNSS 	[12]
	IVHFNSS	The algorithm of the proposed approach for MAGDM	[13]
	NSS to RS	<ol style="list-style-type: none"> 1. The corresponding structures of Pawlak's rough sets, tolerance rough sets, and multigranulation rough sets can be derived from a given N-soft set 2. Integrated use of combinatorial and graph-theoretic techniques to represent tolerance rough structures by N-soft sets 	[14]
	IFNSRS	<ol style="list-style-type: none"> 1. The algorithm of selection of an alternative in an IFNSS. 2. The algorithm of selection of an alternative in an IFNSRS 	[15]

Year	Proposed model	Conclusion/Algorithm	Authors
	N-Soft Topology	Two algorithms for modeling uncertainties in the multi-criteria group decision-making	[16]
2020	MHNSS	The algorithm of the choice value of MHNSS	[17]
	NNSS	Algorithm 1. Neutrosophic N-soft set Algorithm 2. Neutrosophic N-soft set TOPSIS Method	[18]
	GVNSS	The decision-maker uses the two-terminal values α and β of the interval to make the decision	[19]
	NVNSS	It is presented method of priority relation ranking based on neutrosophic vague N -soft sets	[20]
	PFNSS	1. The algorithm of choice values of PFNSS. 2. The algorithm of D -choice values of PFNSS	[21]
2021	CFNSS	1. The algorithm of choice values of CFN-SSs. 2. The algorithm of l -choice values of CFN-SSs 3. The algorithm of the comparison table of CFN-SSs	[22]
	CPFNSS	1. The algorithm of choice values of CPFNSS 2. The algorithm of T-choice values of CPFNSS	[23]

Year	Proposed model	Conclusion/Algorithm	Authors
		3. The algorithm of the comparison table of CPFNSS	
	CSFNSS	1. The algorithm of CSFNSS-TOPSIS method 2. The algorithm of choice values of CSFNSSs. 3. The algorithm of weighted choice values of CSFNSSs.	[24]
	CSVNSS	Steps to deal MAGDM problem by CSVNN-TOPSIS method	[25]
	PFNSS	An algorithm to cope with PFNSS	[26]
	MPNSS	Algorithm 1: (MPNS topology-based method 1). Algorithm 2: (MPNS topology-based method 2)	[27]
	NSRS	The algorithm addresses some limitations of the extended rough sets models in dealing with inconsistent decision problems	[28]
	Multi (Q, N)-soft MGRS	1. The algorithm of multi (Q, N)-soft sets. 2. The algorithm of multi (Q, N)-soft rough sets. 3. The algorithm of multi (Q, N)-soft multi-granulation rough sets	[29]
	MFNSS	Decision-making by weighted choice values of induced HNSSs	[30]

N -soft sets have inspired many researchers in a short period. N -soft sets are not only concerned with theoretical concepts but also include decision-making algorithms and applications.

3 N -SOFT SETS RESEARCH POTENTIAL

It is crucial to uniting the notation to define concepts, extensions, and procedures for N -soft sets. New concepts can be defined clearly to be understood and used effectively in actual data. Some promising further research are M -polar N -soft sets, expanded dual hesitant fuzzy N -soft sets that combine expanded dual hesitant fuzzy [31] with N -soft sets, hesitant N -soft graphs, negative parameters in N -soft sets that inspired from [32], and probabilistic N -soft sets. The researchers can confirm that the new hybrid models are more accurate than those obtained by traditional ones.

Grading non-binary evaluations has become necessary in diverse fields. Thus, future studies in N -soft sets should consider more data sources to reach more relevant research. Researchers can further investigate the applications of N -soft sets hybrid models for data science, forecasting, medical diagnosis, game theory, and social sciences.

On the other side, future research should explore using merge algorithms to select input alternatives and optimal parameters to provide the system's best decision. Future research may also focus on using artificial intelligence analysis to perform N -Soft sets to diverse life challenges better. In web mining, future research can use hybrid model N -soft sets from visitor access patterns to analyze web access logs and find groups of pages that often occur together. Those visits may be used for the prediction of user preferences. Development of decision-making procedures for evaluating the model in terms of the capture of the main parameters. The coding programs for each algorithm in R software.

4 CONCLUSIONS

We have discussed the scope of non-binary values using the N -soft set. This paper recalled an overview about N -soft set paying attention to theoretical concepts including extensions, computational tools, or applications in which N -soft set have provided satisfactory results and fixed a consistent notation.

Forthcoming, we hope novel hybrid models that can improve the performance of N -soft sets with the additional advantages of other uncertainty theories. Some of that ideas can be M -polar N -soft sets, dual hesitant fuzzy N -soft sets, hesitant N -soft graphs, negative parameters in N -soft sets, probabilistic N -soft sets. We can also apply the N -soft set in medical diagnosis, data science, game theory, social sciences, and forecasting in the future. These promising hybridizations will allow us to design more flexible decision-making procedures that fit various people's needs.

REFERENCES

- [1] Molodtsov, D. (1999). Soft set theory—first results. *Computers & Mathematics with Applications*, 37(4-5), 19-31.
- [2] Mostafa, S. M., Kareem, F. F., & Jad, H. A. (2020). Brief review of soft set and its application in coding theory. *Journal of New Theory*, (33), 95-106.
- [3] Saqlain, M., Jafar, M. N., & Riaz, M. (2020). A new approach of neutrosophic soft set with generalized Fuzzy TOPSIS in application of smartphone selection. *Neutrosophic Sets and Systems*, 32, 307-316.
- [4] Liu, J., Chen, Y., Chen, Z., & Zhang, Y. (2020). Multi-attribute decision making method based on neutrosophic vague N -soft sets. *Symmetry*, 12(5), 853.
- [5] Xu, D., Zhang, X., Hu, J., & Chen, J. (2020). A novel ensemble credit scoring model based on extreme learning machine and generalized fuzzy soft sets. *Mathematical Problems in Engineering*

- [6] Abbas, S. M., Alam, K. A., & Shamsirband, S. (2019). A soft-rough set based approach for handling contextual sparsity in context-aware video recommender systems. *Mathematics*, 7(8), 740.
- [7] Hao, F., Park, D. S., & Pei, Z. (2018). When social computing meets soft computing: opportunities and insights. *Human-centric Computing and Information Sciences*, 8(1), 1-18.
- [8] Haruna, K., Ismail, M. A., Suyanto, M., Gabralla, L. A., Bichi, A. B., Danjuma, S., ... & Herawan, T. (2019). A soft set approach for handling conflict situation on movie selection. *IEEE access*, 7, 116179-116194.
- [9] Fatimah, F., Rosadi, D., Hakim, R.B.F., & Alcantud, J. C. R. (2018). *N*-soft sets and their decision making algorithms. *Soft Computing*, 2, 3829–3842.
- [10] Akram, M., Adeel, A., & Alcantud, J. C. R. (2018). Fuzzy *N*-soft sets: A novel model with applications. *Journal of Intelligent & Fuzzy Systems*, 35(4), 4757-4771.
- [11] Akram, M., Adeel, A., & Alcantud, J. C. R. (2019). Group decision-making methods based on hesitant *N*-soft sets. *Expert Systems with Applications*, 115, 95-105
- [12] Akram, M., Adeel, A., & Alcantud, J. C. R. (2019). Hesitant fuzzy *N*-soft sets: A new model with applications in decision-making. *Journal of Intelligent & Fuzzy Systems*, 36(6), 6113-6127.
- [13] Akram, M., & Adeel, A. (2019). TOPSIS approach for MAGDM based on interval-valued hesitant fuzzy *N*-soft environment. *International Journal of Fuzzy Systems*, 21(3), 993-1009.
- [14] Alcantud, J. C. R., Feng, F., & Yager, R. R. (2019). An *N*-soft set approach to rough sets. *IEEE Transactions on Fuzzy Systems*, 28(11), 2996-3007.
- [15] Akram, M., Ali, G., & Alcantud, J. C. R. (2019). New decision-making hybrid model: intuitionistic fuzzy *N*-soft rough sets. *Soft Computing*, 23(20), 9853-9868.

- [16] Riaz, M., Çağman, N., Zareef, I., & Aslam, M. (2019). N-soft topology and its applications to multi-criteria group decision making. *Journal of Intelligent & Fuzzy Systems*, 36(6), 6521-6536.
- [17] Fatimah, F. (2020). Pengambilan keputusan multi hesitant N-soft sets. *Jurnal RESTI (Rekayasa Sistem Dan Teknologi Informasi)*, 4(6), 1110-1116.
- [18] Riaz, M., Naeem, K., Zareef, I., & Afzal, D. (2020). Neutrosophic N-soft sets with TOPSIS method for multiple attribute decision making. *Neutrosophic sets and systems*, 32, 146-170.
- [19] Chen, Y., Liu, J., Chen, Z., & Zhang, Y. (2020). Group decision-making method based on generalized Vague N-soft sets. In *2020 Chinese Control And Decision Conference (CCDC)*, 4010-4015. IEEE.
- [20] Liu, J., Chen, Y., Chen, Z., & Zhang, Y. (2020). Multi-attribute decision making method based on neutrosophic vague N-soft sets. *Symmetry*, 12(5), 853.
- [21] Zhang, H., Jia-Hua, D., & Yan, C. (2020). Multi-attribute group decision-making methods based on Pythagorean fuzzy N-soft sets. *IEEE Access*, 8, 62298-62309.
- [22] Mahmood, T., Ur Rehman, U., & Ali, Z. (2021). A novel complex fuzzy N-soft sets and their decision-making algorithm. *Complex & Intelligent Systems*, 1-26.
- [23] Akram, M., Wasim, F., & Al-Kenani, A. N. (2021). A hybrid decision-making approach under complex Pythagorean fuzzy N-soft sets. *International Journal of Computational Intelligence Systems*, 14(1), 1263-1291.
- [24] Akram, M., Shabir, M., Al-Kenani, A. N., & Alcantud, J. C. R. (2021). Hybrid decision-making frameworks under complex spherical fuzzy N-soft sets. *Journal of Mathematics*.
- [25] Akram, M., Shabir, M., & Ashraf, A. (2021). Complex neutrosophic N-soft sets: A new model with applications. *Neutrosophic Sets and Systems*, 42, 278-301.

- [26] Rehman, U. U., & Mahmood, T. (2021). Picture fuzzy N-soft sets and their applications in decision-making problems. *Fuzzy Information and Engineering*, 1-33.
- [27] Riaz, M., Razzaq, A., Aslam, M., & Pamucar, D. (2021). M-parameterized N-soft topology-based TOPSIS approach for multi-attribute decision making. *Symmetry*, 13(5), 748.
- [28] Zhang, D., Li, P. Y., & An, S. (2021). N-soft rough sets and its applications. *Journal of Intelligent & Fuzzy Systems*, (Preprint), 1-9.
- [29] Akram, M., & Ali, G. (2021). Group decision-making approach under multi (Q, N)-soft multi granulation rough model. *Granular Computing*, 6(2), 339-357.
- [30] Fatimah, F., & Alcantud, J.C.R. (2021). The multi-fuzzy N-soft set and its applications to decision-making. *Neural Computing & Application*. <https://doi.org/10.1007/s00521-020-05647-3>.
- [31] Fatimah, F., & Alcantud, J. C. R. (2018). Expanded dual hesitant fuzzy sets. *International Conference on Intelligent Systems (IS)*, 102-108.
- [32] Fatimah, F., Rosadi, D., & Hakim, R. B. F. (2018b). Probabilistic soft sets and dual probabilistic soft sets in decision making with positive and negative parameters. *Journal of physics: conference series*, 983(1).

MODEL OF BEHAVIOR OF THE PALU CITIZENS IN USING ONLINE SIM REGISTRATION WEB FOR SIM A AND SIM C: TECHNOLOGY ACCEPTANCE MODEL PERSPECTIVE

Shine Pintor Siolemba Patiro¹; Hety Budiyan²;
Lasando Lumbangaol³; Diah Aryani⁴

^{1,3}: Universitas Terbuka; ²Universitas Negeri Makassar,

⁴Universitas Esa Unggul (INDONESIA)

shinepintor@ecampus.ut.ac.id

Abstract

The adopting a new technology behavior is strongly affected by environmental conditions and underlying psychological factors. The gap between education level and social level as the background of this research is very influential toward the adoption of new information technology behavior. Technology Acceptance Model (TAM) is a theory that considered capable in understanding, explaining, and predicting the adoption of an information technology behavior. Thus, this study aims to uncover the application of the TAM development model through the factors that cause perceived usefulness variable (subjective norms, images, and result demonstrability) in understanding, explaining, and predicting the intention of the people in Palu City to use the SIM On Line Web Registration for extending SIM A and SIM C. The study used a sequential exploratory design with a sample size of 300 people which diversified across the city of Palu. Data collection techniques using surveys and purposive sampling. The Social Desirability Response (SDR) test was also conducted in this study to assure the naturalness of the respondents in filling out the questionnaire. The data analysis technique uses Structural Equation Modeling (SEM) with the help of the AMOS application. The results showed that the main predictor variables in TAM affect the intention to adopt the SIM On Line Web Registration application. Perceived usefulness, behavioral intention, and image are influenced

by subjective norms. While the perception of usefulness is affected by the perceived ease of use, image, and results from demonstrability.

Keywords: TAM; SDR; SEM; subjective norms; image; result demonstrability

1 INTRODUCTION

Nowadays, information and communication technology (ICT) is developing rapidly. Based on data from Hootsuite, as of January 2021, there is 7.83 billion population of the world, according to UN data, and 4.66 billion of them have used the internet. Meanwhile, smartphone users have reached 5.22 billion users, and for social media, users have reached 4.2 billion (Fatria, 2021). Based on a survey conducted by the Association of Indonesian Internet Service Providers (APJII) in April 2019, the number of internet users in Indonesia was 171.7 million people which accounted for 64.8% of the total population. Moreover, internet users increased by 10.2% or 27.9 million people when compared to the previous year. This increase is due to rapid infrastructure development in various regions, such as the availability of fiber optic and other supporting communication infrastructure technology that supports internet activities for 540 APJII members (Wahyudiono, 2019).

According to Burhan (2020), one of the ten trends in the development of technology, communication, and information in Indonesia is the increased use of the internet or IoT in the rapidly growing industrial sector. Moreover, the significant growth, both in terms of the types of active consumers and the development of technology applications and communication technology devices, shows that there are excellent opportunities for the evenly distributed development of internet infrastructure throughout Indonesia.

Likewise, Palu, the capital city of Central Sulawesi Province, also experienced significant development in the use of ICT. One of the contributing factors is to avoid clashes between villagers that often occur in Palu. As stated by Aliana (2014) to anticipate the rise of clashes between residents in Palu, the Kabonena Sub-district

government, Ulujadi District, has arranged internet network facilities for the whole community in that area. Further, Kabonena chief of the village, Lukman Lawengah, said that the facility can also help his party in preventing clashes between residents that often occur in Palu. In addition, the public can also learn about ICT. "Internet network facilities are located at the kelurahan office and are intended for the people of Kabonena," according to Lukman Lawengah." Moreover, he also stated that the internet network was specifically intended for teenagers where this group is indicated as the trigger of the clashes. Thus, with the development of ICT, the public is expected to update their information fast (Alihana, 2015).

It has been known that people in Palu have realized the usefulness of ICT. There are several reasons why Palu citizens enjoy using internet technology, which the authors summarize from the results of the author's initial interviews with 10 people in Palu in 2020. These reasons include:

1. Following current trends.

"The majority of our society is very up to date on the developments. Whether it's in the real world or cyberspace. Especially now that the price of gadgets is very low! Almost everyone, young and old, even children, can be connected (online) via a smartphone or tablet. Everything is sophisticated and easy....". (male; 30 years old; civil servant)

2. Means to make friendship

"If we have lost contact with our old friends, we can get reconnected on social media. Just type his name, if he is actively using social media then we can find him again. We can also gather our friends using a special group as a sharing place as well as a reunion. we can also meet new friends from various areas". (adolescent; 19 years old; student)

3. Relieve stress

"For those of us who have a lot of activities, both studying and working, we often experience stress and boredom. In my opinion, social media is one of the most effective ways to release our

boredom. We can share with friends, chat, and much more. Updating social media can eliminate boredom and tiredness when we are waiting for something or when there is no work at the office. Sometimes I'm a little curious to see the activities of my friends. So, with the internet, we can share exciting experiences to relieve stress.” (female; 28 years old; private employee)

4. Network building facilities.

“Just like in the real world, we can also socialize with more people across regions and even across countries. We can follow different communities that suit our interests. For me, social media can bring me together with people who have the same interests. For people who have businesses, social media can expand their network to get customers from all over the country and even abroad.” (male; 40 years old; BUMN employee)

5. As self-identity.

“Using the internet makes us seen as up-to-date people, not ignorant. Nowadays, everything is on the internet everywhere. It's a shame if you don't know what the internet is” (female; 20 years old; student)

6. Gives its satisfaction.

“If there is the internet, many problems can be solved without having to come to the crime scene. I was once asked to help a friend to find information on boarding houses. Just click on the internet, you can immediately get the boarding house he wants.” Likewise, if you want to pay for electricity and water, all you have to do is click on it.” (female; 35 years old; housewife)

The excerpt from the interview above shows that the people of Palu have a positive attitude towards the use of ICT. Additionally, they also have positive subjective norms regarding the use of the internet network in supporting their activities. Based on the perception of usefulness, it is clear from the excerpt, that in general, the people of Palu have a good perception of the usefulness of ICT to support their daily activities. Further, other factors that contribute to their need in using ICT are images related to self-identity and satisfaction from using ICT.

The conditions of application and use of ICT in an organization are a major concern in information systems studies and practice. However, despite impressive progress in terms of hardware and software capabilities, problems related to the underutilization of the system remain. Abdullah and Ward (2016) state that low use of installed systems is a major factor in the “productivity paradox” associated with an organizational investment in information technology. Understanding and creating conditions when information systems are accepted by all members of the organization remains a major issue and priority in research related to information systems.

The Palu Police Traffic Unit (PPTU) starting on October 6, 2015, implemented an online network system for the making of driving license (SIM) and the extension of SIM (Hajiji, 2015). As stated by the Head of Registration and Identification of the PPTU, Ipda Suprojo, in Palu for this initial stage, SIM making using the online network is limited to SIM extensions first but will be applied to the making of new SIMs shortly. Thus, according to him, all data regarding SIM ownership will be synergized between districts/cities and between provinces throughout Indonesia. However, there is a slight problem in implementing online SIM services in Central Sulawesi, namely that there are Police Resort Office (Polres) who do not yet have a SIM Administration Implementing Unit. In addition, the main problem related to online SIM renewal registration is that many people are not accustomed to using electronic devices (computers) and online systems (Hajiji, 2015). He explained that there are around 300 participants who have registered for the online SIM extension, mostly from Palu. Therefore, the Palu Police will try to continue to raise public awareness regarding SIM renewal and extension using an online network system for simplification purposes in providing SIM services.

The appropriate social cognition model in understanding, explaining, and predicting this phenomenon is the *Technology Acceptance Model* (TAM) proposed by Davis (1985). This theoretical model is a development of the *Model Theory of Reasoned Action* (TRA) proposed by Fishbein and Ajzen (2010) regarding the role of

subjective attitudes and norms in explaining and predicting intentions and behavior in social psychology research. In TRA, there are three important items, namely:

1. The existence of conformity in the measurement of attitudes and behavior. In other words, the attitude that is measured is an evaluation of the behavior to be displayed, so that the attitude towards the behavior can explain and predict the behavior displayed.
2. There is a difference between belief and attitude.
3. Explain the relationship between external stimuli, in this case, the attitude object, with beliefs, attitudes, and behavior.

Furthermore, Fishbein and Ajzen (2010) explain the difference between two attitude constructs, the attitude toward the object/*attitude toward the object* (Ao) which is an individual's positive/negative evaluation of a particular object, and the attitude toward the behavior/*attitude toward the behavior* (Ab) which is an individual's positive/negative evaluation of the behavior displayed. Ajzen and Fishbein (1980) state that attitudes toward behavior (Ab) have a stronger relationship with displayed behavior than attitudes toward objects (Ao). Thus, in TAM theory, attitude towards behavior is used to explain and predict behavior. Because the output in TAM theory is to use or not to use technology in their work, so the attitude variable is the attitude towards the use of new technology.

Based on attitude studies in management information systems, Fishbein and Ajzen (2010) distinguish between beliefs that shape attitudes and attitudes themselves. They proposed that beliefs are consequences perceived by individuals as a result of the behavior displayed. In terms of using technology according to TAM theory, the beliefs that shape attitudes towards technology use consist of perceptions of ease of use and perceived usefulness of using the technology (Chauhan and Jaiswal, 2017; Davis, 1989; Hsiao and Yang, 2011).

Perceived usefulness is defined as an individual's level of belief that using a certain technological system will improve his or her performance at work (Davis et al., 1989). Perceived ease of use is defined as the individual's level of belief about the ease with which it is physically and mentally in using a particular technological system (Davis et al., 1989). The TAM model states that the effect of external variables, such as system characteristics, development processes, and training, on intention to use new technology is mediated by perceived usefulness and perceived ease of use (Venkatesh and Davis, 2000).

The last decade has shown significant progress in explaining and predicting the acceptance behavior of the use of information technology in organizations. In particular, the TAM model proposed by Davis (1989) and Davis et al (1989), has provided substantial theoretical and empirical support for this phenomenon. Many empirical studies are showing that the TAM model is consistent in explaining and predicting (about 40%) the use, intention, and behavior of using information technology better than the TRA and TPB models (Venkatesh and Davis, 2000).

However, based on the results of previous studies, the perceived usefulness in the TAM model is consistent in explaining and predicting behavioral intentions. While perceived usefulness is one of the main factors driving the intention to use new technology, it is important to understand the causal factors and the effect of changing these factors over time as experience increases in using the new technology. On the other hand, perceived ease of use is less consistent in explaining and predicting behavioral intentions based on previous studies. Venkatesh and Davis (2000) conducted a study to uncover the factors that cause perceived ease of use associated with a lack of ability to explain and predict intentions to use new technologies. However, the role of perceived usefulness in the TAM model to explain and predict intention to use new technology has always been a major concern for researchers in information systems technology. Therefore, a better understanding of the factors that cause perceived usefulness allows

organizations to design intervention programs so that users can accept the use of new information system technologies. They also showed several factors that shape attitudes towards the behavior of using new technologies, namely: subjective norms, image, job suitability, output quality, and results that can be shown.

Based on the results of initial interviews with ten residents of Palu, their perceptions of usefulness regarding the use of internet network technology are shaped by subjective norms, images, and results that can be shown. Therefore, the TAM model that will be used in this study is extended through the formation of a relationship between the influence of subjective norms, images, and results that can be shown in the perception of usefulness regarding the use of Online SIM Registration Web for SIM A and SIM C extensions which are applied in Central Sulawesi Province on October 6, 2015. Thus, this study aims to reveal the application of the extension of the TAM model through the causal factors of perceived usefulness variables (subjective norms, images, and demonstrable results) in understanding, explaining, and predicting the intentions of the people of Palu to use the Online SIM Registration Web in extending the SIM for SIM A and SIM C groups.

A theoretical review and hypothesis development

Figure 1 shows the extension of the TAM model used in this study by adding subjective norm variables and result in demonstrability which influenced the usability perception variable which in turn formed attitudes towards the use of new technology which had an impact on the intention to use new technology. Similarly, perceptions of ease-of-use shape attitudes toward the use of new technologies, which in turn explain and predict intentions to use new technologies.

Subjective norm and its influence on behavioral intention

According to Fishbein and Ajzen (2010), the subjective norm is an individual's perception regarding the approval of his/her important people to display certain behaviors. In the TRA model proposed by

Fishbein and Ajzen (2010) and the TPB model proposed by Ajzen (1991), subjective norms have a direct effect on behavioral intentions because, although, someone has a negative attitude towards the behavior to be displayed, if his/her important people (reference group) suggest him/her to behave in a certain way, then he/she is motivated to comply with the expectations of this reference group.

Previous studies revealed the influence of subjective norms on intentions to use new technology systems has yielded mixed results. For example, Blut et al (2016) show that subjective norms have an insignificant effect on behavioral intentions, which is contrary to Hwang et al (2016). Davis *et al* (1989) examined the comparison of TAM and TRA models and proposed that subjective norms had an insignificant effect compared to perceived usefulness and perceived ease of use on intentions to use new technology. However, they realize that further research is needed to reveal the social influence on intention and behavior of using new technology through subjective norms. Thus, in this study, we will reveal the influence of subjective norms on behavioral intentions to use internet technology, namely the use of the SIM Online Registration Web for the extension of SIM A and SIM C.

H1: Subjective norms have a positive effect on the intention of the people of Palu to utilize the SIM On Registration Web Line for extension of SIM A and SIM C.

Subjective norms and their effect on perceived usefulness

In the TRA (Ajzen and Fishbein, 1980) and TPB (Ajzen and Madden, 1986) models, subjective norms have a direct influence on behavioral intention as in this study. However, this study also establishes the relationship between the influence of subjective norms on the intention to utilize SIM Online Web Registration technology indirectly through perceived usefulness.

Based on the influence of subjective norms on behavioral intentions mediated by perceived usefulness, two processes are

underlying the relationship, which is internalization and identification. Identification according to Hopp (2013) and Igwe et al (2020) is a process that shows the incorporation of individual beliefs with the beliefs of the reference group regarding the behavior to be displayed. The concept of internalization here is following Baierl et al (2014) who proposed that internalization is a process where informational social influence. In other words, it is an influence because it receives information from other parties as evidence that shows a reality.

As in the context of this study, if the reference group (other people who are considered important) states that the technology is useful, then the people of Palu will have confidence in the SIM Online Registration Web technology, and subsequently, that belief will form an intention to utilize the technology. Under the type of power to French and Raven's taxonomy (1958), namely expert power, that internalization is based on that power (Baierl et al., 2014). The basis for this statement is a reference group (other people who are considered important) who approve or suggest individuals behave in a certain way, are considered to have expertise and credibility related to the behavior displayed (Baierl et al., 2014).

Based on the internalization process, subjective norms have an indirect influence on the intention to use new technology through perceived usefulness, not a direct influence on behavioral intentions based on individual adherence to their reference group (Venkatesh and Davis, 2000). The information processing model based on George and Desmidt (2018) is following the influence of the internalization process which was also proposed by Kelman and Myers (2011).

The TAM model developed in this study shows that the internalization process concerning the influence of subjective norms on behavioral intentions mediated by perceived usefulness will occur in the context of using a technology system that is voluntary or mandatory (Wang and Goh, 2017). Thus, when the perception of the people of Palu regarding the benefits of the SIM Online Registration Web is formed due to the reference group, which presents the response to persuasive social information.

H2: Subjective norms have a positive effect on the perception of the people of Palu regarding the usefulness of using the SIM Online Registration Web.

Image and social influence

Individuals often respond to normative social influences to develop and maintain a good image in front of their reference group (Kelman and Myers, 2011). Mijin et al (2019) examined the diffusion of innovation that defines the image. According to them, image is a level that shows using innovation is an increase in one's status in society. The model used in these studies shows that subjective norms have a positive effect on an image because it is important for an individual in a group or society to display a behavior that is believed to improve his or her self-image in the group or society (Lin et al., 2015; Hopp, 2013). Kelman and Myers (2011) state that the source of social influence is a process of identification that is different from compliance and internalization. Based on the taxonomy of power proposed by French and Raven (1958) that the basis of identification is referent power.

In a work/organizational environment, with a high level of interdependence among organizational members, the status of an individual increase due to the presence of power and influence through the process of social exchange, coalition formation, and resource allocation (Kelman and Myers, 2011). As stated by Laws and Rivera (2012) that an individual who displays certain behaviors and is consistent with group norms will gain recognition as a member of the group, as well as social support as a member of the group. Furthermore, this individual can also achieve his/her goals that only happen in a group action or group membership (Laws and Rivera, 2012).

High power and influence resulting from increased individual status is the basis for generating even greater productivity (Hwang et al., 2016). For example, in a work/organizational environment, a member of the organization perceives that using a new technology

system will improve his or her performance, then this will indirectly improve his/her self-image beyond the performance benefits he receives due to the use of the new technology. Thus, the identification process in this study occurs in the relationship between the influence of subjective norms on self-image, which in turn affects the perception of usefulness.

H3: Subjective norms have a positive effect on the public image of Palu in utilizing the OnLine SIM Registration Web.

H4: The public image of Palu has a positive effect on the perception of the usefulness of using the SIM Online Registration Web.

The results that can be shown and their influence on perceptions of usefulness

The effectiveness of the use of new technology can be seen in the acceptance of the community towards the technology because people feel that the existence of new technology is convenient for daily work. Moreover, this is a result of innovation through the application of new technological systems that affect people's perceptions of their usefulness (Cengiz and Bakirtas, 2020). Hence, individuals are expected to form a positive perception of the usefulness of the new technology system if its use and the positive results are real. On the other hand, if the implementation of a system is effectively able to provide results that are in line with a particular job, but it still looks vague, then system users will not understand the actual use of the system (Gangwar and Date, 2016).

Godoe and Johansen (2012) found a positive and significant correlation between the results indicated by the intention to use a new technology system. The relationship between demonstrable results and perceived usefulness is also consistent in the job characteristics model which emphasizes that knowledge of job outcomes is a key psychological underlying motivation for work (Mortenson and Vidgen, 2016).

H5: The results that can be shown have a positive effect on the perception of the people of Palu on the usefulness of using the SIM Online Registration Web.

Perceived ease of use and its effect on perceived usefulness and intention to use.

In the TAM model, Davis *et al* (1989) stated that the perceived ease of use had a direct effect on the individual's perceived usefulness of the new technology to be used and the perceived usefulness had a direct effect on the intention to use. This is because the perception of usefulness indicates the expected impact of the use of a new technology system on improving job performance, while the perception of ease of use is more directed at the process of using the new technology system (Davis, 1993). In other words, the perceived impact of increased performance is caused by the ease of using the new technology system.

Thus, the application of a new technology system that is easier to use should further increase the benefits for users of the technology. Furthermore, Davis *et al* (1989), and Venkatesh (1999) show that perceived ease of use had a direct influence on intention to use as well as an indirect effect on the intention to use through perceived usefulness.

H6: The perception of the people of Palu on the ease of using the SIM Online Registration Web has a positive effect on the perception of usability.

H7: The perception of the people of Palu on the ease of using the SIM Online Registration Web has a positive effect on the intention to use.

H8: The perception of the people of Palu on the usefulness of using the SIM Online Registration Web has a positive effect on the intention to use.

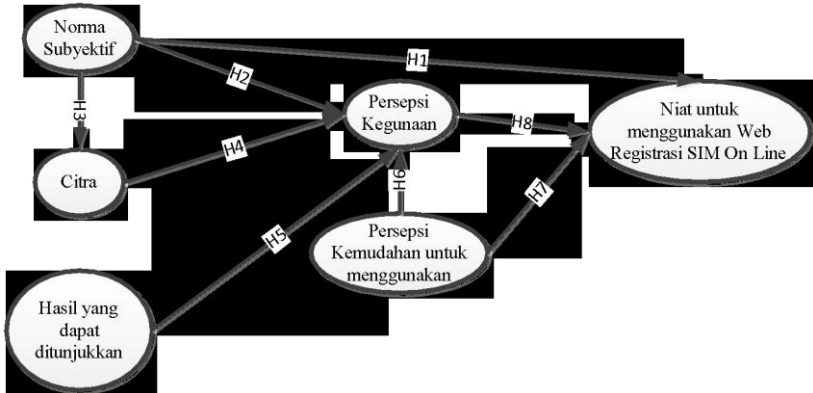

Figure 1. TAM research-development model
 Source: Davis et al (1989); Davis (1993); Venkatesh (1999)

2 METHODOLOGY

This research was conducted qualitatively and quantitatively. The qualitative phase was carried out on September 10, 2015, until September 12, 2015, the period before the implementation of the online SIM registration web. The author conducted a *Focus Group Discussion* (FGD), as a preliminary study, with 10 people consisting of 4 students from one of the universities in Palu, 3 civil servants, and 3 entrepreneurs. The selection of respondents was based on the following considerations: (1) understanding the use of internet network technology, (2) having SIM A or SIM C or both which will expire in December 2015, and (3) being willing to be involved in the research. As stated by Mak and Ip (2017) that the main emphasis of study exploratory is on finding ideas and inputs as it relates to the issue of ecological validity so that the authors choose a research background that is truly real according to the situation and conditions when the online SIM registration web will be implemented. Further, it is also intended to guarantee the generalizability of the research results to other situations and conditions similar to this research.

After conducting the FGD, the author made a transcript from the FGD recording. The transcript was made with the help of a researcher at P2EB UGM. The transcribed FGD recordings were analyzed using content analysis. Mak and Ip (2017) state that in content analysis, validity is not a significant problem. With careful operational definition and appropriate selection of indicators, the coding sheet is assumed to measure adequately. Meanwhile, Ahmed and Ting (2020) proposed that the validity test in content analysis is enough to use *content validity* or *face validity*.

In addition to testing *face validity*, *coding sheets* must also have high reliability. Ringle and Sarstedt (2016) state that the importance of reliability lies in the assurance provided that the data obtained are independent of the event, instrument, or person who measures it. In addition, this reliability test wants to see whether the coding sheet can produce the same findings when carried out by different people. There are 3 ways to test the reliability of coding sheets (Krippendorff, 2004), namely stability, reproducibility, and accuracy. Due to its simple nature, most researchers who use content analysis use the reproducibility method as in this study, where the reliability test was carried out by looking for the value of *the coefficient of reliability*, Holsti (1963) gave the following formula:

$$R = \frac{2(C_{1,2})^2(C_1 + C_2)}{C_1 + C_2 C_1 + C_2}$$

C_{1,2} = Number of categories of assessment results that were approved (considered equal) by all coders.

C₁, C₂ = Sum of all categories used by all coders.

The value of *the coefficient of reliability* generated in this stage is 0.76. The value of *intercoder reliability* is categorized as good because it is more than 0.6 (Holsti, 1963), which means that different people's interpretation of the interview results is the same.

From the results of the FGD, the authors summarized several items selected by at least 10% of the respondents (Fishbein and Middlestadt, 1995), and considered them important as the basis for compiling a questionnaire to be used in conducting *confirmatory factor analysis*. These items include:

1. If the online SIM Registration Web is implemented then I will use it when extending the SIM.
2. If the online SIM Registration Web is implemented then I plan to use it when extending the SIM.
3. If an online SIM Registration Web is implemented then I want to use it when extending SIM.
4. If the online SIM Registration Web is implemented then I am willing to use it when extending the SIM.
5. With the SIM Registration Web online, my work in the office will not be disturbed.
6. Web SIM registration online will save my time in activities.
7. With the online SIM Registration Web, it is easy for me to extend my SIM.
8. I think the online SIM Registration Web is easy to use.
9. In my opinion, the online SIM Registration Web can be accessed anywhere.
10. I'm sure my friends suggest using the SIM Registration Web online when extending the SIM.
11. I'm sure my friends also use SIM Registration Web online when extending SIM.
12. If I use the SIM online Registration Web, I don't look like a tech-savvy person.
13. In my opinion, the use of Web SIM registration online is prestigious.
14. It's easy for me to explain the SIM renewal process to other people if I use the SIM Registration Web online.
15. I feel there are benefits if you use the SIM online Registration Web.

Based on these items, the authors compiled a questionnaire to be used in conducting *Confirmatory Factor Analysis* (CFA) with a total of 150 respondents. CFA was carried out using the SPSS 21 program with the following results (see Table 1):

Table 1. Confirmatory Factor Analysis

Variable	Item	Value factor loading
1	<ul style="list-style-type: none"> If the online SIM Registration Web is applied then I will use it when extending the SIM. 	0.76
	<ul style="list-style-type: none"> If the online SIM Registration Web is implemented then I plan to use it when extending the SIM. 	0.47
	<ul style="list-style-type: none"> If the online SIM Registration Web is implemented then I want to use it when extending the SIM. 	0.89
	<ul style="list-style-type: none"> If the online SIM Registration Web is implemented then I am willing to use it when extending the SIM. 	0.44
2	<ul style="list-style-type: none"> With the online SIM Registration Web, my work in the office will not be disturbed. 	0.77
	<ul style="list-style-type: none"> Web SIM registration online will save my time in activities. 	0.85
3	<ul style="list-style-type: none"> With the SIM Registration Web online, it is easy for me to extend my SIM. 	0.39
	<ul style="list-style-type: none"> I think the online SIM Registration Web is easy to use. 	0.81
	<ul style="list-style-type: none"> I think the online SIM Registration Web can be accessed anywhere. 	0.73
4	<ul style="list-style-type: none"> I'm sure my friends recommend using the online SIM Registration Web when extending the SIM. 	0.76

Variable	Item	Value factor loading
	<ul style="list-style-type: none"> I'm sure my friends also use the SIM Registration Web online when extending their SIM. 	0.83
5	<ul style="list-style-type: none"> If I use the SIM Registration Web online, I don't look like a tech-savvy person. 	0.74
	<ul style="list-style-type: none"> I think the use of the online SIM Registration Web is prestigious. 	0.71
6	<p>2 It is easy for me to explain the SIM renewal process to other people if using the online SIM Registration Web.</p>	0.92
	<ul style="list-style-type: none"> I feel there are benefits if using the SIM Registration Web online. 	0.90

Based on the results of Table 1, it can be seen that item 2 and item 4 in variable 1 and item 1 in variable 3 have a loading factor value below 0.6, so the authors decided to exclude these items. Then, we test the construct validity back (discriminant validity and validity of convergence) uses the same 150 respondents, with the following results (see Table 2):

Table 2. Results of the validity and reliability

Variable	Item	Values Loading factor	AVE	CR	α
1	<ul style="list-style-type: none"> If the Web SIM online registration is applied, I will use it when extending the SIM. 	0.66	0.522	0.684	0.766
	<ul style="list-style-type: none"> If the online SIM Registration Web is implemented then I want to use it when extending the SIM. 	0.78			
2	<ul style="list-style-type: none"> With the SIM Registration Web online, my work in the office will not be disturbed. 	0.76	0.570	0.726	0.865
	<ul style="list-style-type: none"> The SIM Registration site online will save me time in the move. 	0.75			
3	<ul style="list-style-type: none"> I think the online SIM Registration Web is easy to use. 	0.91	0.759	0.862	0.771
	<ul style="list-style-type: none"> I think the online SIM Registration Web can be accessed anywhere. 	0.83			
4	<ul style="list-style-type: none"> I'm sure my friends recommend using the SIM Registration Web online when extending the SIM. 	0.86	0.636	0.884	0.976

Variable	Item	Values Loading factor	AVE	CR	α
	<ul style="list-style-type: none"> I'm sure my friends also use a SIM Registration site online when extending a license. 	0.73			
5	<ul style="list-style-type: none"> If I use the SIM Registration Web online, I don't look like a tech-savvy person. 	0.94	0.856	0.922	0.739
	<ul style="list-style-type: none"> According to my use, the SIM Registration site online is of greater prestige. 	0.91			
6	<ul style="list-style-type: none"> It is easy for me to explain the SIM renewal process to other people if using the online SIM Registration Web. 	0.72	0.579	0.733	0.822
	<ul style="list-style-type: none"> I feel there are benefits when using the SIM Registration Web online. 	0.80			

The results of the discriminant validity test in Table 2 show that the items or indicators used to represent the construct to be measured with a factor loading value above 0.6. As stated by Hair *et al* (2014) that the loading factor value above 0.6 for each indicator representing the construct to be measured has good discriminant validity.

The AVE value which indicates the validity of the convergence is obtained by calculation with the formula:

$$AVE = \frac{\sum_{n=1}^i (\lambda_i^2)}{n}$$

n = number of measurement indicators; λ_i = *factor loading* (Hair et al., 2014)

The results of calculation of the value AVE produced more than 0.5, thus, the three constructs have a good convergent validity (Hair et al., 2014; Kock, 2019).

The value of construct reliability generated in this study was obtained through the formula:

n = number of measurement indicators; λ_i = *factor loading* (Hair et al., 2014)

Table 2 also shows that the value of *Cronbach alpha* and *composite reliability* of each construct exceeds 0.7, thus the measure used in this study is *reliable* (Hair et al., 2014; Kock, 2019). In this study, the method of reliability test used is a *composite of reliability*, which is better to estimate the internal consistency of a construct (Hair et al., 2014; Ringle and Sarstedt, 2016)

Development of a scale of measurement in research using scales of measurement used by previous researchers, such as indicators for variables of perceived usefulness, perceived ease of use, and behavioral intentions were adapted from Davis (1989) and Davis et al (1989). Subjective norm variable indicators were adapted from Taylor and Todd (1995). Indicators of self-image variables and results that can be shown are adapted from Moore and Benbasat (1991). Based on the results in Table 2 then: variable 1 is the intention to use the SIM Online registration web (2 indicators); variable 2 is perceived usefulness (2 indicators); variable 3 is the perceived ease of use (2 indicators); variable 4 is a subjective norm (2 indicators); variable 5 is self-image (2 indicators), and variable 6 is the result that can be shown (2 indicators).

Socially Desirable Response

The *Socially Desirable Response* (SDR) test is conducted using a *non-paired sample*, for each indicator of the 6 constructs measured. In doing so, we entrusted each of the 30 questionnaires in the South Palu District for the questionnaire with direct questions and in the West Palu District (Pondok Indah Simple Restaurant) for the questionnaire with indirect questions. This test was performed using non-parametric statistics using SPSS 16. For *non-paired samples*, the test used was Mann *Whitney*. The test results show that the p-value obtained is more than 0.05 which concluded that the two samples (*non paired*) come from a population that has the same average (*mean*) or expectations. In other words, the average respondents' answers from both samples are the same. For more details see Table 3.

Table 3. Test Results Socially Desirable Response

Constructs	Indicators Measurement	Value p
intention to use	I1	0.831
	I2	0,363
perception of usefulness	PU1	0.797
	PU2	0.309
Perceived ease of use	PoU1	0.599
	PoU2	0.088
Norma subjectively	SN1	0.357
	SN2	0.850
Citra	img1	0.230
	img2	0,400
results can be shown	RD1	0.611
	RD2	0.788

3 RESULTS

Characteristics of Respondents

Respondents of this study consist of 300 people. All of these respondents have SIM A and SIM C with a validity period that will expire in December 2015. Of the 300 people, 67.5% were male and 32.5% were female; 64.2% married and 35.8% unmarried; 20.8% aged 30 years and under, 33.3% aged 31 to 45 years, and 45.8% aged 45 years and over; 8.33% are students, 25% work as civil servants, 39.2% work as employees in private companies, 26.7% work as employees in State-Owned Enterprises, and 0.83% work elsewhere; 8.33% were high school graduates, 50% were undergraduates, and 41.7% were postgraduates; 64.2% of the respondents have SIM C and 35.8% have SIM A; 67% of them earn IDR 2,400,000 – IDR 4,000,000 and 33% more than IDR 4,000,000.

Structural Model Test Results

The sample size used in this study is 300 respondents obtained through a survey using a purposive withdrawal technique. There are no clear directions for determining the appropriate sample size for using SEM. For example, Rakotoa Simbola and Bili (2018) state that a sample size of 100 - 200 is a sufficient number to use SEM. With a sample of 300 people, this number follows the considerations above. Data analysis in this study used Structural Equation Modeling (SEM) with the help of IBM SPSS AMOS 23 software. The selection of SEM estimation techniques for this study was based on the consideration that the data contained outliers and were not normal. Thus, the Maximum Likelihood (ML) estimation technique was determined to be used. This is because it is very suitable for the assumption of data normality that is not met (Tabachnick and Fidell, 2019; Kock, 2019; Ringle and Sarstedt, 2016; Alam et al., 2019; Weijters and Baumgartner, 2019)

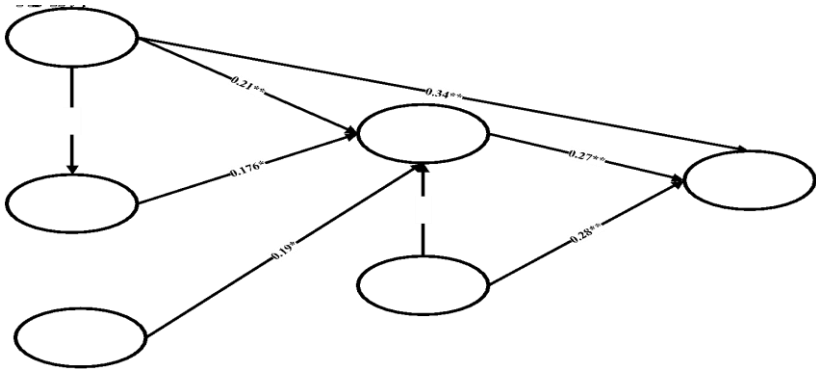

Figure 2. Structural model test results

Remarks : * significant at $p < 0.05$; ** significant at $p < 0.001$

Table 4. The Goodness of fit v model

Type goodness of fit model	Index goodness of fit model	Recommended value	Result	Information
Absolute fit measures	Chi-square statistic (χ^2 or CMIN)	Small	5.801	Good
	P	≥ 0.05	0.604	Good
	GFI	≥ 0.90	0.976	Good
	RMSEA	≤ 0.08	0.050	Good
Incremental fit measures	Normed ² (CMIN/DF)	$2 \leq \text{Normed}^2 \leq 5$	2.771	Good
	CFI	≥ 0.94	0.951	Good
Parsimonious fit measures	AGFI	≥ 0.90	0.983	Good

Table 5. Estimated Structural Parameters

Path Hypothesis	Path coefficient	t-value	Conclusion
H1	0.340	3.100**	Supported
H2	0.211	2.200**	Supported
H3	0.156	2.002*	Not Supported
H4	0.176	*	Supported
H5	20130.190 2.186	*	Supported
H6	0.220	2.329**	Supported
H7	0.280	2.901*	Supported
H8	0.270	2.333*	Supported

Note: * significant at $p < 0.05$; ** significant at $p < 0.001$

The results of this study indicate that the extended TAM model, used in this study, can explain and predict the intention of the Palu citizens to use the Online SIM Registration Web implemented by the Central Sulawesi Provincial Government. TAM was developed by adapting the Theory of Reasoned Action (TRA) to explain the causal relationship between the user's internal beliefs (usability and ease of use), attitudes, intentions, and usage behavior. Although, in the last 20 years TAM has successfully emerged as a well-established model capable of explaining and predicting user acceptance of the technology (Venkatesh and Davis, 2000), several studies have attempted to validate the developed TAM model with all its original constructs such as this study.

This study uses an extended TAM model by combining three additional variables, namely subjective norms, self-image, and demonstrable results. In general, the two main variables in the TAM model, perceived usefulness and perceived ease of use can explain and predict the intention of the people of Palu to use the online SIM registration web which will be implemented by the Central Sulawesi provincial government. Overall, the variance in the intention of the people of Palu to use the online SIM registration web can be explained by predictor variables of 48% and the rest is explained by other factors outside the model.

The first hypothesis in this study is supported. As the results presented in Table 5, the Critical Ratio (t-statistic) value is above 1.96, implying that the more positive the subjective norms possessed by the people of Palu regarding the use of the Online SIM Registration Web for the extension of SIM A and SIM C, the more it will affect their intention to use them. The results of this study further emphasize the influence of subjective norms on behavioral intentions. As stated by Fishbein and Ajzen (2010) that the direct effect of subjective norms on behavioral intentions is that people will display a behavior, even though he/she does not prefer the behavior or its consequences as a result of his/her belief in one or more people whom they consider important who suggest/agrees on those certain behaviors, and is sufficiently motivated to comply (Fishbein and Ajzen, 2010).

TAM studies that have successfully demonstrated the direct effect of subjective norms on behavioral intentions have yielded mixed results. For example, research conducted by Patiro et al (2016), Patiro and Budiyanto (2016), and Patiro and Sihombing (2014) found a significant effect of subjective norms on behavioral intentions. Cengiz and Bakirtas (2020) also state that some psychological studies suggest that subjective norms are important determinants of perceived usefulness and behavioral intentions. As stated earlier, TRA identified subjective norms and attitudes as determinants of behavioral intentions (Davis et al., 1989), but the original TAM model did not include subjective norms as a variable.

The use of information technology can stem from an individual's desire to perform such actions, which implies that user perceptions may influence the decision to participate or not (Godoe & Johansen, 2012). Many studies have been conducted and show that subjective norms positively influence individual behavior related to technology acceptance and use (Mortenson & Vidgen, 2016). Following Venkatesh and Davis (2000) who stated that subjective norms were included in the model as an effort to increase understanding of user adoption behavior and acceptance of new information systems and technologies. The results of this study indicate that the people of Palu

intend to use the online SIM registration web to extend SIM A and C if the people closest to them advise them to use it.

The second hypothesis in this study is supported. As the results show. in Table 5, that the Critical Ratio (t-statistic) value is above 1.96. This means that the more positive the subjective norms regarding the use of the online SIM registration web application for the extension of SIM A and SIM C, the people of Palu will feel a positive perception about the usefulness of the application.

The direct relationship between subjective norms and behavioral intentions in TRA and TPB is based on the principle of compliance. The TAM model in this study includes two additional theoretical mechanisms that subjective norms can influence intentions indirectly through perceived usefulness. The two mechanisms are internalization and identification as proposed by Venkatesh and Davis (2000). Internalization refers to the process when an individual feels that important people think he or she should accept and use the system. Additionally, he incorporates the beliefs of the important person into his belief structure. Internalization is equivalent to that referred to by Deutsch and Gerard (1955) as quoted by Sharma et al (2016), informational social influence (as opposed to normative), which is defined as “the influence of receiving information from others as evidence of the existence of reality. In the context of this current study, if a supervisor, co-worker, colleague, friend, or relative suggests that the online SIM registration web system is very useful in extending SIM A and SIM C, then someone might believe that the system is really useful, and ultimately form an intention to use it.

In the case of internalization, subjective norms have an indirect effect on intentions through perceived usefulness, as compared to a direct adherence effect on intentions. Salancik and Pfeffer (1978) examined the social information processing model (cited by Venkatesh and Davis (2000)), where the results are consistent with the resulting internalization effect in this study. The TAM model developed in this study explains the concept of internalization. According to Hsiao and Yang (2011), internalization is not a form of

compliance. In addition, internalization will appear in the context of acceptance and use of systems that are voluntary or mandatory, when the use of the system is carried out by what is mandated or is mandatory, the user's perception of the usability will increase in response to persuasive social information. Thus, as in this study, when the online SIM registration web is perceived to be of real benefit, then the information conveyed by the web user to relatives, friends, co-workers, colleagues, and superiors will be well internalized which in turn will form the intention to want to participate and use it.

The third hypothesis is also supported in this study. The results of the support for this hypothesis can be seen in Table 5 which is indicated by the Critical ratio (t-statistic) value that exceeds 1.96. Individuals often respond to social normative influences to build or maintain their image held in reference groups (Hsiao and Yang, 2011). Moore and Benbasat (1991) cited by Venkatesh and Davish (2000) define an image as "the extent to which the use of innovation is considered to improve a person's image which has an impact on his status in a social system.

The TAM model developed in this study states that subjective norms will affect This is because, if an individual believes that he or she should perform the behavior (eg, using the system) as suggested by his reference group, then he will then do so and that will tend to improve his position in the group to which he belongs (Partala and Saari, 2015).

Based on the taxonomic perspective of power proposed by French and Raven (1959) as cited by Venkatesh and Davis (2000), the basis for identifying a person's image is based on the strength of a reference group. In a typical work environment, with a high degree of interdependence high among members of society in carrying out its duties, the increase in status in the group is the basis of power and influence through processes such as social exchange, coalition formation, and resource allocation (Abbasi et al., 2015). As stated by Faqih et al (2015) by performing behavior that is consistent with group norms, an individual will achieve a special status and social support

received from his group so that it has a positive impact on his self-image. The background of this research is the application of an online SIM registration web system to extend SIM A and SIM C. Therefore, like it or not, the people of Palu City are required to adopt the system, although it is not a necessity. This is because the people of Palu City maintain the image they have in community groups that they are people who tend to be open to new technological systems. Thus, his subjective norms will affect his self-image when faced with the acceptance and use of a new technology system, which in this case is an online SIM registration web.

The fourth hypothesis is supported by the results shown in Table 5. According to Deutsch and Gerard (1955), informational social influence can be defined as the influence received when a person accepts information obtained from others as evidence of the fact that happened. The informational social influence will be accepted if it is considered as an instrument for finding solutions to some problems faced by individuals, or because it supports or adds to what individuals already believe about some prominent aspects of their environment (Burnkrant and Cousineau, 1975).

When an individual feels that there is still insufficient information, an ambiguous situation, or an immediate demand to perform an action or decision, it will make people replace information that seems to be considered more competent than others through direct proof of their own (Cohen and Golden, 1972). Lee and Hong (2016) show that when an individual makes a purchase decision, he/she tends to receive informational social influence if he thinks that information from others (for example, product reviews) will help him achieve the goal of reducing buying costs.

Increased power and influence resulting in higher status will be the common basis for greater productivity gains (Sharma et al., 2020). Thus, an individual learns that using the system will lead to an increase in his or her performance (which is the definition of perceived usefulness) which is indirectly due to an improved image, on top of all the performance benefits that are directly attributed to the use of the

new technology system (Venkatesh and Davis, 2000). As in the background of this study, the image observed by people of Palu as a consequence of perceived subjective norms will shape their perception that using an online SIM registration web when extending a SIM will provide many benefits. The benefits he will receive are the information he receives from his reference group when he will decide to behave or not. This will affect his self-image as a representation of the reference group related to the acceptance or use of the new system.

The fifth hypothesis in this study is also well supported. The results perceived by Palu citizens regarding the use of online SIM registration web when extending a SIM have further increased their perception of the usefulness of the new system and technology. The results of this study are in line with Moore and Benbasat (1991), Agarwal and Prasad (1999), and Zhang et al (2010). Results demonstrability is defined as the extent to which the results obtained from using new systems and technologies can be seen and communicated (Moore & Benbasat, 1991). Further, this variable is crucial when adopting an innovation (Agarwal & Prasad, 1999). According to Moore and Benbasat (1991) and Agarwal and Prasad (1999), there is a significant correlation between behavioral intentions to adopt and the results that can be demonstrated. Zhang et al (2010) examined mobile health applications, stated that the results that can be shown are considered real and observable because they can express and share with others their pleasant experiences while using certain mobile health applications.

This study shows that when the people of Palu have a pleasant experience in using the online SIM registration web application to extend their SIM, they will deliver this information to their closest people. Therefore, supporting Venkatesh and Davis (2000) who state that the results that can be demonstrated, are tangible aspects of the results when the individual uses a new technological innovation and will directly shape and affect the perceived usefulness, which implies that individuals can be expected to form more positive perceptions of

the usefulness of a system if the covariance between use and positive outcomes is easy to see. On the other hand, if a new system and technology produce work that is relevant and effective by the results desired by users, but is not visible in reality, then system users will not likely understand how useful the system is (Gow et al., 2019). Empirically, Calisir et al (2014) also found a close and significant relationship between perceived usefulness of use and proven results. The relationship between demonstrable results and perceived usefulness is also consistent with the job characteristics model, which emphasizes knowledge of the actual results of work activities as a psychological state that underlies work motivation.

The sixth hypothesis is also well supported in this study. These results can be seen in Table 5 which is indicated by the Critical Ratio (t statistic) value above 1.96. The results of this study indicate that the more positive the perception of the people of Palu in using the online SIM registration web application, the perception of the people of Palu regarding the usefulness of the application is also more positive.

The TAM model developed in this study adopts the TAM model proposed by Davis et al (1989) by linking perceived ease of use to perceived usefulness variables, because the easier a system is to use, the more it will increase the perceived job performance (Venkatesh and Davis, 2000; Dwivedi et al. 2016). There is plenty of empirical evidence accumulated over a decade which shows that perceived ease of use will have a positive and significant effect on the intention to use, either directly or indirectly through its effect on perceived usefulness (Davis et al. 1989; Venkatesh, 1999; Venkatesh and Davis, 2000). For example, the TAM model developed by Venkatesh and Davis (1996) considers that ease of use is the psychological basis for a person's self-efficacy towards a new technological system that is adjusted to the objective usefulness that is felt through direct behavioral experience in using the system. As a result of this study, Palu citizens who find it easy to use the online SIM registration web application automatically immediately feel the benefits that will be received when they use the application.

The TAM model developed by Davis et al (1989) integrates perceived ease of use of technology and perceived usefulness of technology as two main constructs. The perception of usability in this study shows the extent to which the people of Palu believe that using an online SIM registration web application will improve their performance. The existence of an online SIM registration web application should provide various benefits for its users, especially the people of Palu, such as general convenience, simplification of payments compared to other forms of payment, all of which may support a positive attitude towards use and a higher intention to use the application when extending driver's license.

The perception of the ease of using the online SIM registration web application shows the perception of the people of Palu about the effort and time on using the service and the extent to which the technology can be understood. Previous studies have consistently acknowledged that perceived ease of use has a direct effect on perceived usefulness and attitudes (Chauhan, 2015; Yousafzai et al., 2007). A study using TAM also revealed that there is a significant positive relationship between perceived ease of use and perceived usefulness (Van der Heijden, 2003; Yang, 2012). Thus, as the results of this study, the ease of using the online SIM registration web application system when extending a SIM can affect the perception of usability and attitudes of users.

Hypothesis seven is also supported. The results of this study indicate that the higher the positive perception of the people of Palu regarding the ease of using the online SIM registration web application, the more they will intend to use it when extending their SIM.

The theory of reasoned action (TRA) proposed by Ajzen and Fishbein (1980) states that attitudes have an important role in explaining and predicting the intention to engage in the behavior. The theory of planned behavior (TPB) and the technology acceptance model (TAM) are each separate derivatives of TRA but are considered as their development. In particular, the TPB extends the TRA to

include a new determinant of behavioral intention, namely perceived behavioral control (Taylor and Todd, 1995).

Perceived behavioral control according to Schifter and Ajzen (1985) and Ajzen and Madden (1986) describes the extent to which people perceive they have control over the behavior they display. The logic of perceived behavioral control refers to the concept of self-efficacy proposed by Bandura (1977) (cited by Fishbein and Ajzen (2010)). According to Bandura (1977) self-efficacy means that individuals are more likely to engage in behaviors they believe they can control compared to behaviors they believe are less controllable (cited by Fishbein and Ajzen (2010)).

The TAM model was developed at the same time as the TPB development. The TAM model is based on the concept of TRA, which proposes a set of determinants of behavioral intentions, especially for the behavior of adopting systems and information technology. These determinants include perceived ease of use, which refers to the degree to which a person believes that using a particular system will be free from difficult effort (Venkatesh and Davis, 2000). The effort is a limited resource that a person can allocate to various activities for which he is responsible (Fishbein and Ajzen, 2010). The results of this study indicate applications that are considered easier to use will be more likely to be accepted by potential users. Moreover, the results also show when the online SIM registration web application was launched by the Palu Police, the Palu citizens perceived that the application was accessible and user-friendly when used to extend a SIM. The application is expected to provide convenience for the people of Palu when extending a SIM.

Finally, the eighth hypothesis is also well supported. The more positive the perception of the people of Palu City regarding the usefulness of the online SIM registration web application, the higher the intention to want to use the application.

Perceived usefulness is defined as the extent to which a person believes that using a particular system will improve his/her job performance (Venkatesh and Davis, 2000). This refers to the definition

of the word useful, i.e. capable of being used profitably (Davis, 1989; Venkatesh and Davis, 2000). In an organizational context, people are generally forced to produce good performance with salary increases, promotions, bonuses, and other rewards (Robbins and Judge, 2013). A system that has high perceived usefulness is a system that is believed by users to produce a positive relationship between use and performance (Venkatesh and Davis, 2000).

The results of this study are in line with Davis et al (1989), Lin and Lu (2000), Moon and Kim (2001), and Taylor and Todd (1995) which successfully demonstrated that perceived usefulness was able to explain and predict individual behavioral intentions in the behavior of adoption of new information systems and technologies. The higher the perceived usefulness of the new information technology system, the higher the intention to use it. Further, the perceived usefulness is the subjective probability that using technology will improve the way users complete a given task. Based on theories in social psychology, such as the TRA (Ajzen and Fishbein, 1980; Fishbein and Ajzen, 1975) and the TPB (Schifter and Ajzen, 1985; Ajzen and Madden, 1986), the TAM has been validated as a robust conceptual framework (Davis, 1989; Davis et al., 1989).

Davis et al. (1989) stated that perceived usefulness refers to consumers' perceptions of the outcomes of past experiences. The experience of the people of Palu in the past when interacting with the internet will create information about the usefulness of the internet. Based on this, when the online SIM registration web application was launched by the Palu Police as a means of assistance for the community to extend a SIM, the people of Palu have a positive perception of the usefulness of the application because it was considered to increase their comfort in doing so. With the formation of positive perceptions about the benefits of the online SIM registration web application, the intention of the people of Palu to use the application is increasing.

4 CONCLUSIONS

The TAM is a very popular model for understanding, explaining, and predicting the use of new information technology systems. To date, there have been many impressive studies on the application of the TAM model. Although several studies have confirmed the ability of the TAM model to explain and predict new information systems and technologies, there is still some skepticism among researchers regarding the application and theoretical accuracy of this model. Consequently, the authors are interested in concluding that research on TAM may have reached a saturation level, so that future research will focus on developing new models that will take advantage of the strengths of the TAM model while improving on its weaknesses.

In general, the extension of the TAM model in this study has successfully explained and predicted the behavior of people who adopt a new information technology system. As the background of the study is the behavior of the people of Palu in using the SIM registration web application online. Furthermore, the results of this study show that the eight hypotheses proposed are well supported, indicating that the TAM model used in this study has a good explanatory ability to the behavior of the people of Palu related to the behavior of adopting a new information technology system, namely the Online SIM registration.

Behavioral intentions can be explained and predicted well by the two main predictor variables, namely perceived usefulness and perceived ease of use. Perceived usefulness can be explained by perceived ease of use. Several additional variables which in this case are considered as antecedents of perceived usefulness, namely: subjective norms, images, and results that can be shown can explain these variables well. Subjective norms can explain and predict behavioral intentions very well which further emphasizes its role as an antecedent of intention as stated in the TRA and TPB models.

Managerial implications

The results of this study can be used as a basis for internet technology service providers in identifying and understanding the antecedent factors of prospective users' intentions in adopting the new

internet system and technology. To increase the intention of potential users of the technology services offered, service providers must focus on the usefulness and ease of use of the system. Service providers do not need to reproduce redundant features but preferably features that are user-friendly so that users can feel more useful and easier when using them. Further, service providers must consider reference group factors that can influence potential users' intentions to adopt the new technology system. Hence, the resulting technological system must be able to be accessed and used by various levels of society so that the system can be well received.

Limitations and suggestions

This study only measures up to the behavioral intention. Thus, the actual behavior of the people of Palu has not been seen in adopting the online SIM registration web application. Henceforth, it is hoped that the research conducted can measure up to the stage of actual behavior.

This research is cross-sectional to determine the causal path of several variables being measured. Future research is expected to be able to be carried out longitudinally so that it can be carried out until the measurement of actual behavior. In addition, future research should consider experimental or longitudinal studies so that better conclusions regarding causality can be drawn.

This study only covers the people of Palu in Central Sulawesi Province. In the future, it is hoped that the research carried out will be able to cover all districts/cities in Central Sulawesi Province and even throughout Indonesia so that generalization of research results can be carried out.

REFERENCES

- [1] Abbasi, M. S., Tarhini, A., Elyas, T., & Shah, F. (2015). Impact Of Individualism And Collectivism Over The Individual's Technology Acceptance Behaviour: A Multi Group Analysis Between Pakistan And Turkey. *Journal Of Enterprise Information Management*, 28(6), 747–768.
- [2] Agarwal, R. And Prasad, J. (1997). The Role Of Innovation Characteristics And Perceived Voluntariness In The Acceptance Of Information Technologies. *Decision Sciences*, 28(3): 557-582.
- [3] Ajzen, I. (1991). The Theory Of Planned Behavior. *Organizational Behavior And Human Decision Processes*, 50(2), 179–211
- [4] Ajzen, I., & Fishbein, M. (1980). *Understanding Attitudes And Predicting Social Behavior*. Englewood-Cliffs, Nj: Prentice-Hall.
- [5] Ajzen, I., & Madden, T. J. (1986). Prediction Of Goal-Directed Behavior: Attitudes, Inten-Tions, And Perceived Behavioral Control. *Journal Of Experimental Social Psychology*, 22, 453-474.
- [6] Ahmed, S. And Ting, D. H. (2020). Shopping Cues: Conceptualization, Scale Development, And Validation. *International Journal Of Market Research*, 62(1), 95–112
- [7] Alam, T. F., Sultana, N., And Rayhan, M. I. (2019). Structural Equation Modeling: An Application
- [8] Of Broadband Penetration And Gdp Growth In Asia. *Journal Of Economic Structures*, 8(17), 1-11
- [9] Alihana, F. (2015), "Antisipasi Bentrok, Lurah Siapkan Fasilitas Internet, "Metro Sulawesi.Com, Tersedia Di: [Http://Www.Metrosulawesi.Com/Article/Antisipasi-Bentrok-Lurah-Siapkan-Fasilitas-Internet](http://Www.Metrosulawesi.Com/Article/Antisipasi-Bentrok-Lurah-Siapkan-Fasilitas-Internet), Diakses Pada Tanggal 31 Mei 2017.
- [10] Baierl, R., Grichnik, D., Spörrle, M., & Welpel, I. M. (2014). Antecedents Of Social Entrepreneurial Intentions: The Role Of An Individual's General Social Appraisal. *Journal Of Social Entrepreneurship*, 5(2), 123–145.
- [11] Blut, M., Wang, C. & Schoefer, K. (2016) Factors Influencing The Acceptance Of Self-Service Technologies: A Meta-Analysis. *Journal Of Service Research*, 19, 4, Pp..396–416.

- [12] Burhan, F. A. (2020). 10 Tren Teknologi 2020, Kecerdasan Buatan Dan 5g Berkembang Pesat. *Kata Data*, Tersedia Di: <https://katadata.co.id/Agustiyanti/Digital/5e9a4c3a63f7e/10-Tren-Teknologi-2020-Kecerdasan-Buatan-Dan-5g-Berkembang-Pesat>, Diakses Pada Tanggal 4 Mei 2021.
- [13] Burnkrant, R.E. And Cousineau, A. (1975). Informational And Normative Social Influence In Buyer Behavior. *Journal Of Consumer Research*, 2(3): 206–215.
- [14] Calisir, F., Gumussoy, C., Bayraktaroglu, A., & Karaali, D. (2014). Predicting The Intention To Use A Web-Based Learning System: Perceived Content Quality, Anxiety, Perceived System Quality, Image, And The Technology Acceptance Model. *Human Factors And Ergonomics In Manufacturing & Service Industries*, 24(5), 515–531.
- [15] Cengiz, E. And Bakirtas, H. (2020). Technology Acceptance Model 3 In Understanding Employee's Cloud Computing Technology. *Global Business Review*, 1–20
- [16] Chauhan, S. (2015). Acceptance Of Mobile Money By Poor Citizens Of India: Integrating Trust Into The Technology Acceptance Model. *Info*, 17(3): 58–68
- [17] Chauhan, S., & Jaiswal, M. (2017). A Meta-Analysis Of E-Health Applications Acceptance: Moderating Impact Of User Types And E-Health Application Types. *Journal Of Enterprise Information Management*, 30(2), 295–319.
- [18] Cohen, J. B. And Golden, E. (1972). Informational Social Influence And Product Evaluation. *Journal Of Applied Psychology*, 56: 54–59.
- [19] Davis, F. D. (1985). A Technology Acceptance Model For Empirically Testing New End-User Information Systems: Theory And Results. Unpublished Doctoral Dissertation, Mit Sloan School Of Management, Cambridge, Ma.
- [20] Davis, F. D. (1989). Perceived Usefulness, Perceived Ease Of Use, And User Acceptance Of Information Technology. *Mis Quarterly*, 13(3), 319–340

- [21] Davis, F. D. (1993). User Acceptance Of Computer Technology: System Characteristics, User Perceptions. *International Journal Of. Man-Machine Studies*, 38 (3), 475-87.
- [22] Davis, F. D., Bagozzi, R. P., & Warshaw, P. R. (1989). User Acceptance Of Computer Technology:
- [23] A Comparison Of Two Theoretical Models. *Management Science*, 35(8), 982–1003.
- [24] Deutsch, M., And Gerard, H. B. (1955). A Study Of Normative And Informational Social Influences Upon Individual Judgment. *Journal Of Abnormal And Social Psychology*. 51: 629–636.
- [25] Dwivedi, Y., Shareef, M., Simintiras, A., Lal, B., & Weerakkody, V. (2016). A Generalised Adoption Model For Services: A Cross-Country Comparison Of Mobile Health (M-Health). *Government Information Quarterly*, 33(1), 174–187.
- [26] Faqih, K. M., & Jaradat, M. I. R. M. (2015). Assessing The Moderating Effect Of Gender Differences And Individualismcollectivism At Individual-Level On The Adoption Of Mobile Commerce Technology: Tam3 Perspective. *Journal Of Retailing And Consumer Services*, 22, 37–52.
- [27] Fatria, J. (2021) Pengguna Internet Di Dunia Capai 4.66 Miliar. *Kalbaronline*, Tersedia Di: <https://www.kalbaronline.com/2021/02/04/pengguna-internet-di-dunia-capai-4-66-miliar/>, Diakses Pada Tanggal 4 Mei 2021.
- [28] Fishbein, M. And S. Middlestadt (1995), “Non Cognitive Effects On Attitude Formation And Change: Fact Or Artifact? “*Journal Of Consumer Psychology*, Vol. 4, No. 2, Pp. 181-202.
- [29] Fishbein, M. And Ajzen, I. (2010). Predicting And Changing Behavior: The Reasoned Action Approach. New York, Ny: Psychology Press Taylor And Francis Group Llc
- [30] Gangwar, H., & Date, H. (2016). Critical Factors Of Cloud Computing Adoption In Organizations: An Empirical Study. *Global Business Review*, 17(4), 886–904.

- [31] Godoe, P., & Johansen, T. (2012). Understanding Adoption Of New Technologies: Technology Readiness And Technology Acceptance As An Integrated Concept. *Journal Of European Psychology Students*, 3(1), 38–52.
- [32] Gow, C. X., Wong, S. C., And Lim, C. S. (2019). Effect Of Output Quality And Result Demonstrability On Generation Y's Behavioural Intention In Adopting Mobile Health Applications. *Asia-Pacific Journal Of Management Research And Innovation*, 15(3): 111–121.
- [33] Hair, J. F., W. C. Black, B. J. Babin, And R. E. Anderson (2014), *Multivariate Data Analysis*, 7th Ed. Essex, England: Pearson Education, Ltd.
- [34] Hajiji, M (2015),” Satlantas Palu Terapkan Perpanjangn Sim Secara Online, “Antara Sulteng.Com, Tersedia Di: [Http://Www.Antarasulteng.Com/Berita/21524/Satlantas-Palu-Terapkan-Perpanjangn-Sim-Secara-Online](http://www.antarasulteng.com/Berita/21524/Satlantas-Palu-Terapkan-Perpanjangn-Sim-Secara-Online), Diakses Pada Tanggal 29 Mei 2017
- [35] Holsti, O.R. (1963), “Content Analysis,” In Robinson, J.A. Ed., *The Quantitative Analysis Of Content: A Handbook With Application For The Study Of International Crisis*, Nortwestern: Nortwestern University Press, Pp. 596-692.
- [36] Hopp, T. M. (2013). Subjective Norms As A Driver Of Mass Communication Students' Intentions To Adopt New Media Production Technologies. *Journalism & Mass Communication Educator*, 68(4): 348–364.
- [37] Hsiao, C. H., & Yang, C. (2011). The Intellectual Development Of The Technology Acceptance
- [38] Model: A Co-Citation Analysis. *International Journal Of Information Management*, 31(2), 128–136
- [39] Hwang, Y., Al-Arabiati, M., And Shin, D-H. (2016). Understanding Technology Acceptance
- [40] In A Mandatory Environment: A Literature Review. *Information Development*, 32(4): 1266–1283

- [41] Kelman, S., & Myers, J. (2011). Successfully Achieving Ambitious Goals In Government: An Empirical Analysis. *American Review Of Public Administration*, 41, 235-262.
- [42] Kock, N. (2019). Factor-Based Structural Equation Modeling With Warppls. *Australasian Marketing Journal*, 27, 57–63
- [43] Krippendorff, K. (2004). *Content Analysis An Introduction To Its Methodology*. 2nd Edition, Thousand Oaks, California: Sage Publications, Inc
- [44] Laws, V. L. And Rivera, L. M. (2012) The Role Of Self-Image Concerns In Discrepancies Between Implicit And Explicit Self-Esteem. *Personal Social Psychology Bulletin* 38(11): 1453–1466.
- [45] Lee, J. And Hong, I. B. (2016). Predicting Positive User Responses To Social Media Advertising: The Roles Of Emotional Appeal, Informativeness, And Creativity. *International Journal Of Information Management*, 36: 360–373
- [46] Lin, C. C. J., & Lu, H. (2000). Towards An Understanding Of The Behavioural Intention
- [47] To Use A Web Site. *International Journal Of Information Management*, 20(3), 197–208.
- [48] Lin, T. T. C., Younbo, J., And Sim, C. (2015). Towards An Understanding Of Intention To Use Mobile Videos: Impression Management, Perceived Facilitation, And Social Norms. *Mobile Media & Communication*, 3(1) 106–124
- [49] Mak, M. K. Y. And Ip, W. H. (2017). An Exploratory Study Of Investment Behaviour Of Investors. *International Journal Of Engineering Business Management*, 9: 1–12
- [50] Mijjin, N., Jang, H., Choi, B., And Khongorzul, G. (2019). Attitude Toward The Use Of Electronic Medical Record Systems: Exploring Moderating Effects Of Self-Image. *Information Development*, 35(1): 67–79
- [51] Moon, J. W., & Kim, Y. G. (2001). Extending The Tam For A World-Wide-Web Context. *Information And Management*, 38(4), 217–230.

- [52] Moore, G. C., And Benbasat, I. (1991). Development Of An Instrument To Measure The Perceptions Of Adopting An Information Technology Innovation. *Information Systems Research*, 2(3): 192–222.
- [53] Mortenson, M. J., & Vidgen, R. (2016). A Computational Literature Review Of The Technology Acceptance Model. *International Journal Of Information Management*, 36(6), 1248–1259.
- [54] Partala, T., & Saari, T. (2015). Understanding The Most Influential User Experiences In Successful And Unsuccessful Technology Adoptions. *Computers In Human Behavior*, 53, 381–395.
- [55] Rakotoasimbola, E. And Blili, S. (2019). Measures Of Fit Impacts: Application To The Causal Model Of Consumer Involvement. *International Journal Of Market Research*, 61(1), 77–92
- [56] Ringle, C. M. And Sarstedt, M. (2016). Gain More Insight From Your PLS-Sem Results: The Importance-Performance Map Analysis. *Industrial Management & Data Systems*, 116(9), 1865–1886
- [57] Robbins, S. P. And Judge, T. A. (2013). *Organizational Behavior*. 15th Edition, Upper Saddle River, New Jersey: Pearson Education, Inc
- [58] Schifter, D. E. And Ajzen, I. (1985). Intention, Perceived Control, And Weight Loss: An Application Of The Theory Of Planned Behavior. *Journal Of Personality And Social Psychology*, 49(3), 843–851.
- [59] Sharma, S. K., Al-Badi, A. H., Govindaluri, S. M., & Al-Kharusi, M. H. (2016). Predicting Motivators Of Cloud Computing Adoption: A Developing Country Perspective. *Computers In Human Behavior*, 62, 61–69.
- [60] Sharma, M., Gupta, R., & Acharya, P. (2020). Prioritizing The Critical Factors Of Cloud Computing Adoption Using Multi-Criteria Decision-Making Techniques. *Global Business Review*, 21(1), 142–161
- [61] Tabachnick, B. G. And Fidell, L. S. (2019). *Using Multivariate Statistics*. 7th Edition, Usa: Pearson Education, Inc Or Its Affiliates

- [62] Taylor, S. And Todd, P. (1995). Decomposition And Crossover Effects In The Theory Of Planned Behavior: A Study Of Consumer Adoption Intentions. *International Journal Of Research In Marketing*, 12(2): 137–155
- [63] Van Der Heijden, H. (2003). Factors Influencing The Usage Of Websites: The Case Of A Generic Portal In The Netherlands. *Information And Management*. 40(6): 541–549
- [64] Venkatesh, V. (1999). Creation Of Favorable User Perceptions: Exploring The Role Of Intrinsic Motivation. *Mis Quarterly*. 23(2): 239–260.
- [65] Venkatesh, V. And Davis, F. D. (1996). A Model Of The Antecedents Of Perceived Ease Of Use: Development And Test. *Decision Science*. 27(3): 451–481.
- [66] Venkatesh, V., & Davis, F. D. (2000). A Theoretical Extension Of The Technology Acceptance
- [67] Model: Four Longitudinal Field Studies. *Management Science*, 46(2), 186–204.
- [68] Wahyudiono (2019). Implikasi Penggunaan Internet Terhadap Partisipasi Sosial Di Jawa Timur. *Jurnal Komunika*, 8(2): 63-68
- [69] Wang, X. And Goh, D. H-L. (2017). Video Game Acceptance: A Meta-Analysis Of The Extended Technology Acceptance Model. *Cyberpsychology, Behavior, And Social Networking*, 20(11): 662-671
- [70] Weijters, B. And Baumgartner, H. (2019). Analyzing Policy Capturing Data Using Structural Equation Modeling For Within-Subject Experiments (Semwise). *Organizational Research Methods*, 22(3), 623-648
- [71] Yang, K. (2012). Consumer Technology Traits In Determining Mobile Shopping Adoption: An Application Of The Extended Theory Of Planned Behavior. *Journal Of Retailing And Consumer Services*. 19(5): 484–491

- [72] Yousafzai, S.Y.; Foxall, G.R.; And Pallister, J.G. (2007).
Technology Acceptance: A Meta-Analysis Of The Tam: Part 2.
Journal Of Modelling In Management. 2(3): 281–304
- [73] Zhang, H., Cocosila, M., & Archer, N. (2010). Factors Of Adoption
Of Mobile Information Technology By Homecare Nurses.
Computers, Informatics, Nursing (Cin), 28(1), 49–56.

COMPUTER REPAIR MONITORING SYSTEM DESIGN IN THE COMPANY

Agni Isador Harsapranata

Bina Sarana Informatika University

agniiisador@gmail.com

Abstract

Technological developments today are unavoidable, have a good impact on the running of a company's business. In this study the authors are interested in designing a computer repair system in the company. In this study, the author uses the waterfall method, so that all stages of the system design can be observed in detail at each stage. The design of this system aims to facilitate management in the IT department, in monitoring the repair process of computers that need repair, either in the process of purchasing new parts, or there are improvements in the program side, until the computer is completed under repair. In this design, the speed of the repair stages can be monitored, and if there is a delay in repairs, departmental leaders can intervene directly, what are the obstacles in the computer repair process. This design utilizes open source applications, namely, Php programs, Apache servers, and Mysql databases. By utilizing a Web-based program, it makes it easier for every employee in the company to use the application either by using a smartphone or a desktop computer, compared to before, every employee in the company had to use email or telephone to confirm whether the computer repair had been completed or not.

Keywords: Apache, Php, Mysql, Information Systems

1 INTRODUCTION

The speed of development of business processes in a company encourages every part of the company to create procedures that are faster in producing a report. So that the faster reports are made, helping decision makers to make the right decisions. One part that is

quite important in the company is the IT department, in that section there is a responsibility to ensure that the entire system can run properly, so that the company's business processes are not disrupted. With this, the authors are interested in conducting research to create a system design that helps to record all computer repair activities, so that it can make it easier for each department in the company to find out the progress of improvements being made by the IT department. The repair process involves the repair process, the purchase of computer spare parts, and the process of deleting computer assets if the device cannot be repaired.

2 METHODOLOGY

In this study the author uses the Waterfall method[1], where in this method the stages of research are: Requirements Analysis, Design, Implementation, Verification, Maintenance, in the description as shown in Figure 1.

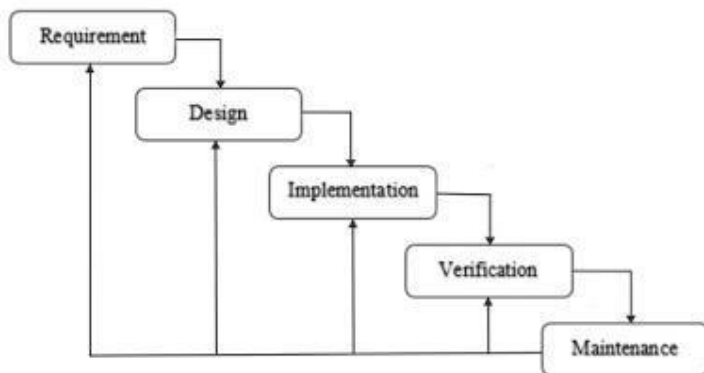

Figure 1. Waterfall model [1]

In the waterfall method, the author uses an approach using the Unified Modeling Language diagram, and the following are the stages that the author does in designing this information system:

a. Requirements Analysis

In the needs analysis stage, the author observes the system that is already running, and also analyzes all input and output documents.

b. Design

In the needs analysis stage, the author observes the system that is already running, and also analyzes all input and output documents. In the design stage, the author uses a Use Case Diagram, as shown in Figure 2.

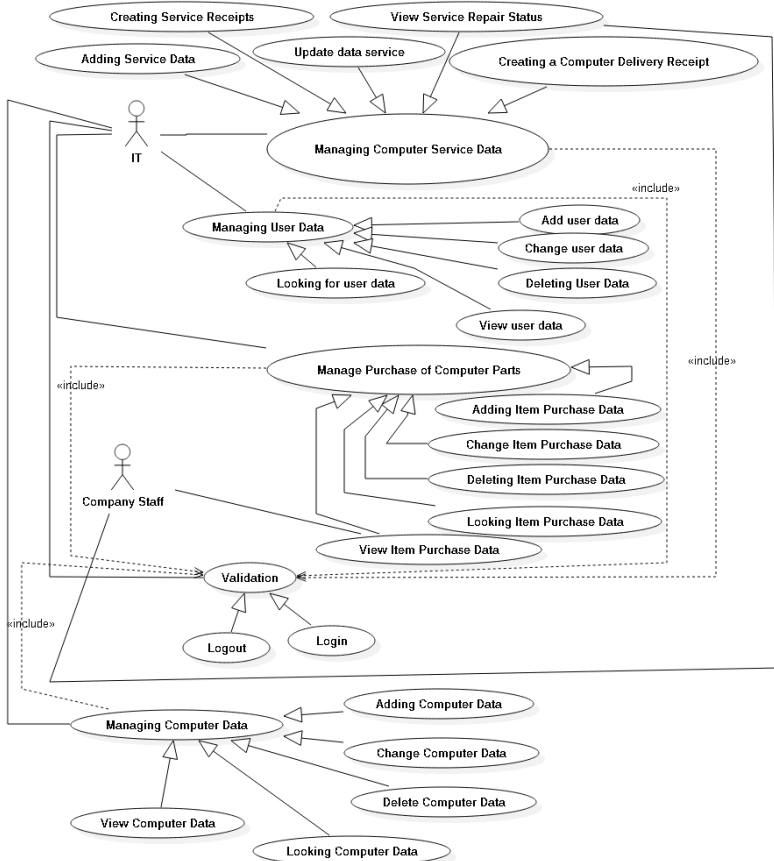

Figure 2. Use Case Diagram Monitoring System.

From the Use Case diagram as shown in Figure 2, it can be explained as follows:

1. Actor : IT

Description : Managing Computer Service Data

- a. IT can adding service data.
- b. IT can Creating service receipts.

- c. IT can update data service.
 - d. IT can view service repair status.
 - e. IT can creating a computer delivery receipt.
2. Actor : IT
Description: Managing User Data
- a. IT can adding user data.
 - b. IT can change user data.
 - c. IT can delete user data.
 - d. IT can view user data.
 - e. IT can looking user data.
3. Actor : IT
Description: Manage Purchase of Computer Parts
- a. IT can adding item purchase data.
 - b. IT can change item purchase data.
 - c. IT can delete item purchase data.
 - d. IT can view item purchase data.
 - e. IT can looking item purchase data.
4. Actor : IT
Description: Managing Computer Data
- a. IT can adding computer data.
 - b. IT can change computer data.
 - c. IT can delete computer data.
 - d. IT can view computer data.
 - e. IT can looking computer data.
5. Actor : IT
Description: Validation
- a. IT can login to the system.
 - b. IT can logout from the system.
6. Actor : Company Staff
Description: View Service Repair Status
- a. Company Staff can View Service Repair Status.
7. Actor : Company Staff
Description: View Item Purchase Data
- a. Company Staff can View Item Purchase Data.

And after making a design using a Use Case diagram, the author continues to use a class diagram, as shown in Figure 3. According to Rosa in Software Engineering [2], the class diagram describes the structure of the system in terms of defining the classes that will be created to build the system. Classes have what are called attributes and methods or operations. And for an explanation of the class can be seen in Table 1.

Table 1. Class Diagram Monitoring System

Class Name	Description
UserInformationSystem	Is a class that handles users and authorities in the use of information systems
ComputerData	Is a class that handles computer part data
ComputerServiceData	Is a class that handles computer service data
ManagingUserData	Is a class that handles user data queries
ManagingComputerData	Is a class that handles computer data queries
ManagingComputerServiceData	Is a class that handles computer service data queries
PurchaseData	Is a class that handles purchase data
ManagePurchaseofComputerParts	Is a class that handles purchase data queries
Validation	Is a class for user authentication
Interface	Is a class that handles each form view
DatabaseConnection	It is a class that handles database connections and querying data
Main	Is a Main class

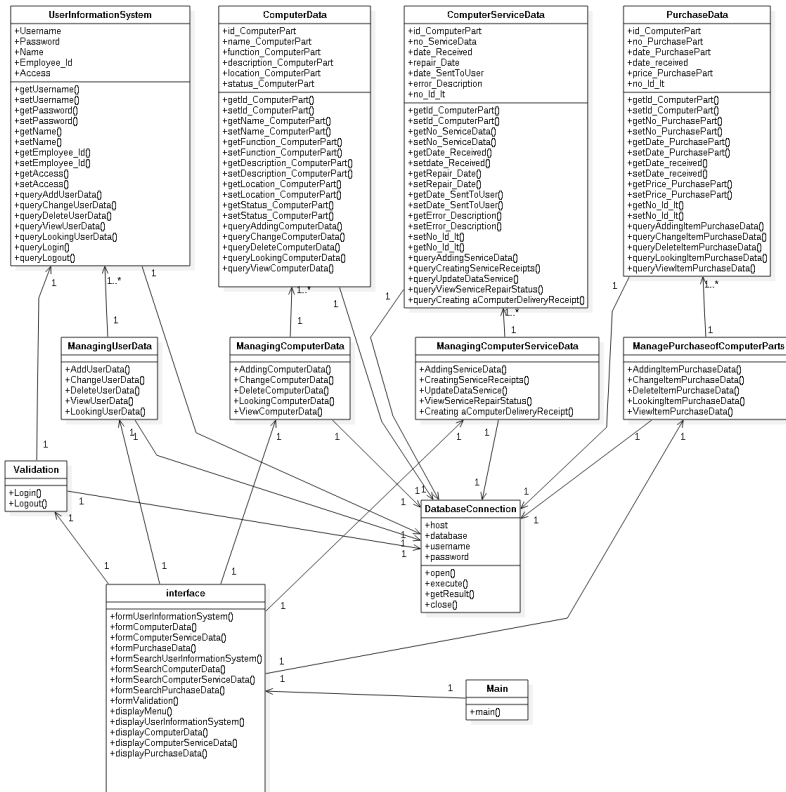

Figure 3. Class Diagram Monitoring System.

After designing the class diagram, the author continues the design using an activity diagram as shown in Figure 4.

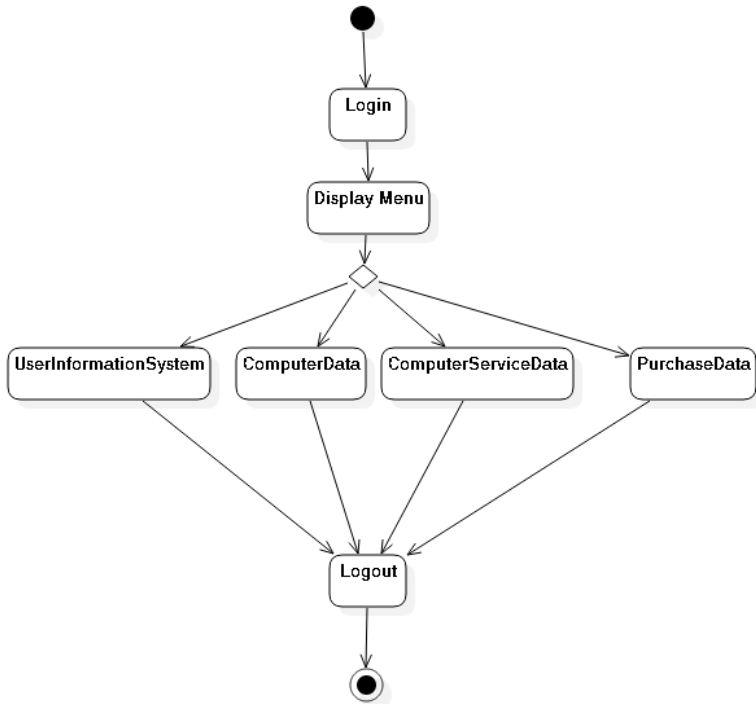

Figure 4. Activity Diagram Monitoring System.

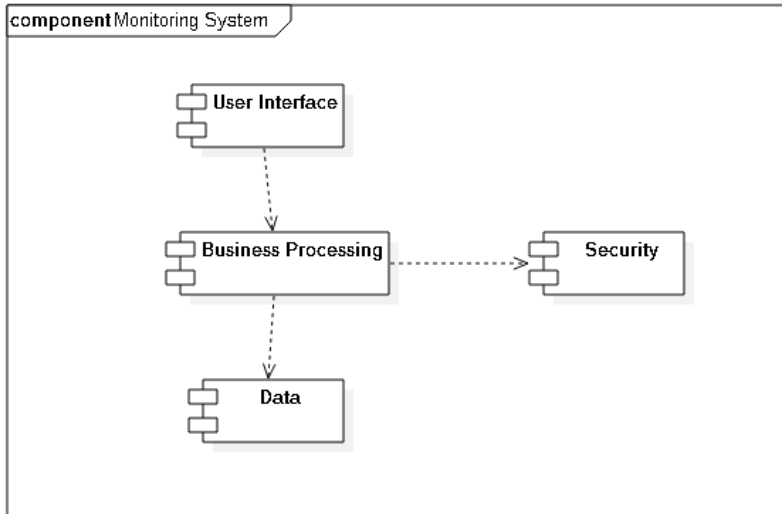

Figure 5. Component Diagram Monitoring System.

Can be seen in Figure 5, Component Diagram Monitoring System, describes the design of the relationship between components on the server, in running the information system. After making the component design, the author continues with a sequence diagram, where here the author displays a sequence diagram for the managing user data section, as shown in Figure 6.

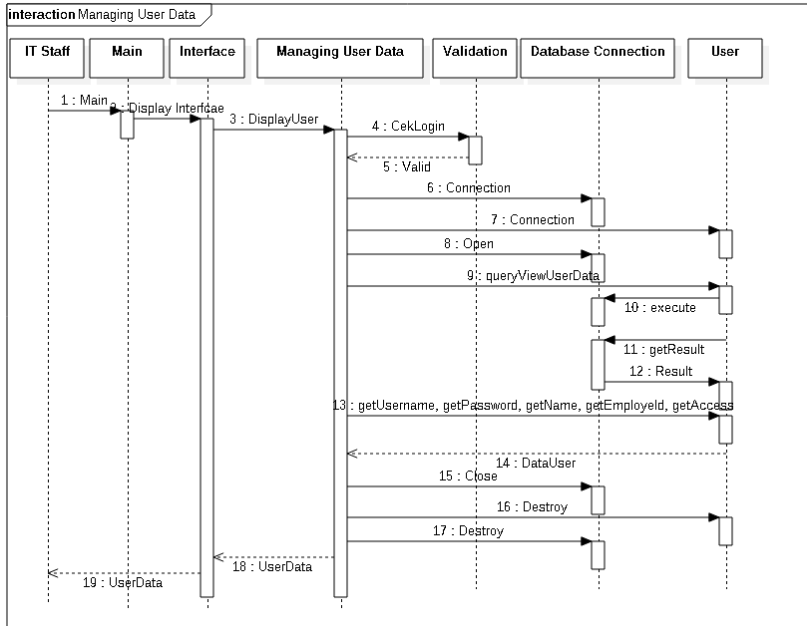

Figure 6. Sequence Diagram Managing User Data.

c. Implementation

In this stage, the author implements both the program code and database to be run directly, and is tested at every stage of the process, and ensures that each stage of the process can run according to the system design that has been made.

d. Verification

In this stage, the author verifies the stages of each information system process, and ensures that it has input and output in accordance with the design and expectations of users of the information system. Where both the PHP program, Web Server, and Mysql Database can run well and do not experience errors, in the course of the information system process.

e. Maintenance

At this stage the author ensures that the system is always in good working condition, the author monitors the mysql database, where the mysql database is an open source product [2], so ensuring that the product is always in an updated condition and does not experience problems, as well as for open source programs. PHP and Apache Web Server[3].

3 RESULTS

After doing the design, the following is the result of the application that is run as shown in Figure 7, is the display of logging into the information system.

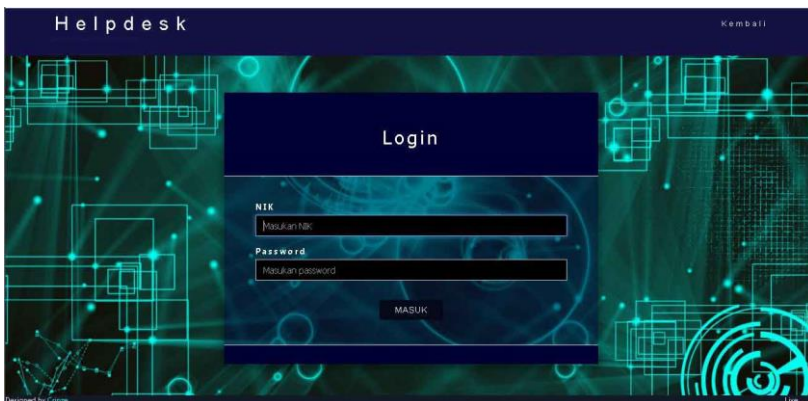

Figure 7. Login Form

4 CONCLUSIONS

With this information system, it makes it easier for communication between company staff and the IT department, as a service provider, plus also assists the IT Manager in monitoring the performance of each IT staff in it.

REFERENCES

- [1] A. I. Harsapranata, “Perancangan Kontrol Rumah Menggunakan Internet Of Things Memanfaatkan Telegram Dan ESP8266,” in *Seminar Nasional Multi Disiplin Ilmu*, 2020, pp. 978–979, [Online]. Available: <https://www.unisbank.ac.id/ojs/index.php/sendu/article/view/7989>.
- [2] A. isador Harsapranata, “PERANCANGAN WEB LOADBALANCING , SSL , DAN SINKRONISASI DATA SERVER MENGGUNAKAN OPEN SOURCE DI ASTRIDO,” in *Seminar Nasional Teknologi 2019*, 2019, pp. 677–682, [Online]. Available: <https://jurnal.teknikunkris.ac.id/index.php/semnastek2019/article/view/335>.
- [3] R. Taufiq *et al.*, “RANCANG BANGUN SISTEM INFORMASI PENGOLAHAN NILAI SISWA BERBASIS WEB PADA SMK PUTRA RIFARA TANGERANG Rohmat,” in *SEMINAR NASIONAL MULTI DISIPLIN ILMU*, 2020, pp. 978–979, [Online]. Available: <https://www.unisbank.ac.id/ojs/index.php/sendu/article/view/8011>.

SENTIMENT ANALYSIS TO DETERMINE THE POPULARITY OF THE MARKETPLACE USING THE NAIVE BAYES CLASSIFIER METHOD

Adinda Rizka Chlorine Subagyo¹, Wahyu Wibowo²

^{1,2}Faculty of Vocational, Institut Teknologi Sepuluh Nopember,

Surabaya, (INDONESIA)

rizkaadinda13@gmail.com

Abstract

Marketplace is a platform with the aim of being an intermediary between sellers and buyers in online product transactions. The number of marketplaces in Indonesia is increasing from year to year. This cause buyer to be confused about choosing an online shopping site with safe and convenient transaction process. Three highest marketplaces with good reputations in Indonesia are Shopee, Tokopedia, and Lazada. This research is to determine the popularity of the marketplace among Shopee, Tokopedia, and Lazada using sentiment analysis. Sentiment is an assessment or opinion about services on the marketplace, which captures positive or negative opinions. A marketplace with a positive response shows that the marketplace has high popularity compared to other marketplaces. This research uses the Naïve Bayes Classifier method on Shopee, Tokopedia, and Lazada reviews obtained from the Google Play site. The result of this research show that Lazada is leading as a marketplace that has the highest popularity compared to Shopee, Tokopedia and Lazada, with a positive sentiment percentage for Lazada at 75%, Tokopedia at 70%, and Shopee at 63%.

Keywords: Marketplace, Naïve Bayes Classifier, Sentiment Analysis

1 INTRODUCTION

In March 2019, Indonesia was ranked 5th in the world in terms of the largest number of internet users namely 143,46 million users[1]. The high number of internet users in Indonesia indicates that various activities can be carried out using the internet, such as accessing social media and games. Marketplace is one of the sites frequently visited by internet users in Indonesia. Marketplace is a platform with the aim of being an intermediary between sellers and buyers in online product transactions. Three highest marketplaces with good reputations in Indonesia are Shopee, Tokopedia and Lazada [2].

Shopee is a marketplace from Singapore and was released in 2015. The advantages of Shopee are the easy application and payment method, and it also has a Cash on Delivery (COD) payment feature. The disadvantages of Shopee are complicated free shipping promos and incomplete bank payments. Meanwhile, Tokopedia is a marketplace from Indonesia and was released in 2014. The advantage of Tokopedia is fast and complete payment method. The disadvantage of Tokopedia there is no address setting and both in the application and the website, the size of thumbnail is small. Lastly, Lazada is a marketplace from Germany and was released in 2012. The advantages of Lazada are fast delivery and various products. The disadvantage of Lazada is the payment confirmations take quite a long time and the Cash on Delivery (COD) payment feature is only available in a few cities [3]. Each marketplace has advantages and disadvantages. Buyers will certainly choose to shop at the best marketplace among Shopee, Tokopedia and Lazada. Thus, an assessment is needed to compare services between Shopee, Tokopedia and Lazada through sentiment analysis.

Sentiment analysis is one of the fields of computer science that studies linguistic computing, natural language processing, and text mining to analyze emotions or someone's assessment of a particular product or activity [4]. The sentiments of Shopee, Tokopedia and Lazada users contain review comments on several sites, one of which is Google Play. Based on this review, a sentiment analysis will be

carried out to determine the popularity of the marketplace among Shoppe, Tokopedia and Lazada using the Naïve Bayes Classifier method.

Naïve Bayes Classifier is a simple probability-based prediction technique method from the application of Bayes' Theorem with strong independent assumptions [5]. This method works very well compared to other classification models. Naïve Bayes Classifier has a better accuracy rate than other classification models [6]. Therefore, in this research, the Naïve Bayes Classifier method will be used for sentiment analysis.

This research will compare the number of reviews between Shopee, Tokopedia and Lazada. Then classify using the Naïve Bayes Classifier method, and evaluate the measurement of classification accuracy using accuracy, sensitivity, AUC (Area Under Curve) and G-Mean (Geometric Mean) to see the level of model accuracy in classifying. Thus, the result of the review classification can be used to determine popularity among Shopee, Tokopedia and Lazada based on the number of reviews that contain positive responses.

2 METHODOLOGY

Data obtained by technique scraping on webpage Google Play. The data used are Shopee, Tokopedia and Lazada users reviews on 1 November 2020 - 22 January 2021 as much as 6.000 reviews. The variables in this study consisted of predictor variables, namely basic words in each review and the response variables, namely the classification of review sentiments: positive or negative.

Text mining is the discovery of new and previously unknown information by computers, which automatically extract information from different unstructured text sources [7]. Text mining data sources that come from relatively unstructured text because it uses human grammar or commonly called natural language.

Data preprocessing is the initial stage of text mining to prepare documents into structured data. Data preprocessing goes through several steps, namely: slang word (change non-standard words into

standard words), filtering (remove unimportant words using stopword), tokenization (break words into more meaningful or token), and stemming (change affixed words to root words) [8].

K-fold cross validation is a method to partitioning data into training data and test data. This method is often used in research because it can reduce bias. Standard method for evaluation is 10-fold cross validation. Research previous studies show that 10-fold cross validation is the best choice to get an accurate estimate. Best number of folds for validity test, recommended using 10-fold cross validation [9].

Naïve Bayes Classifier is a simple probabilistic classification algorithm that calculates a set of probabilities by adding up the frequency and combination of values. This algorithm uses Bayes Theorem and assumes all attributes are independent [10]. Advantages of using Naïve Bayes Classifier is this method only requires a small amount of data (training data) to determine estimates parameters needed in the classification process.

$$P(C_j|X_1, X_2, \dots, X_n) = \frac{P(X_1, X_2, \dots, X_n|C_j)P(C_j)}{P(X_1, X_2, \dots, X_n)} \quad (2)$$

Where $P(C_j|X_1, X_2, \dots, X_n)$ represents probability class C_j on X_1, X_2, \dots, X_n (posterior), $P(X_1, X_2, \dots, X_n|C_j)$ represents probability X_1, X_2, \dots, X_n on class C_j (likelihood), $P(C_j)$ represents probability of class C_j (prior), and $P(X_1, X_2, \dots, X_n)$ represents probability of X_1, X_2, \dots, X_n (evidence). The value of $P(X_1, X_2, \dots, X_n)$ is always fixed for each in one review. The values of $P(C_j|X_1, X_2, \dots, X_n)$ will be compared with other $P(C_j|X_1, X_2, \dots, X_n)$ values to determine the classification of reviews.

Classification is to make an assessment of an object data to enter into a certain class from a number of class which available [5]. Classification techniques are best suited for predicting or describing data set with binary and nominal category, however less effective for ordinal categories [11]. Classification and prediction result can be evaluated using measurement classification of accuracy.

Measurement classification of accuracy aims to see the performance of the classification. In measuring the classification of accuracy, it is necessary to know the number in each prediction class and actual class which consist of True Positive (TP), True Negative (TN), False Positive (FP) and False Negative (FN). Measurement that are often used to calculate classification accuracy are accuracy, sensitivity, specificity [12]. While there are unbalanced data, measurement of classification accuracy using G-Mean and AUC (Area Under Curve) [13].

Word cloud is a visualization method frequently used text document. Word cloud aims to graphical display of a document done with plotting words that often appear in two-dimensional space. Word cloud displays popular words appears from a document. Frequency of frequent words appears indicates high frequency appearance of the word in documents [14].

Several studies were conducted for sentiment analysis. Research to determine the popularity of the marketplace shows Lazada leading as the most popular marketplace between Bukalapak and Blibli.com, with the percentage of the popularity level of Lazada, Bukalapak and Blibli.com being 95.9%, 93.7% and 89.3% [15]. Another study showed that the results of Shopee sentiment classification using The Naïve Bayes Classifier obtained an accuracy rate of 97.4% [8]. Research using a classification based on the Naïve Bayes Classifier algorithm to rank the popularity of tourist destinations in Bali shows that in fact, Kuta Beach is the most popular tourist spot in Bali. When compared with the results of the study, it was found that the ranking often changed [16]. In addition, research on the use of internet to examine one item sets shows that both male and female mostly use the internet to access social media. While the examination of two item sets shows that both male and female mostly use the internet to access financial services and news. The use of association rule mining to examine three item sets shows that the majority of male user access e-mail, financial services, and news. Meanwhile, some female user access to financial services, goods/services and news [17].

3 RESULTS

This section will describe the number of reviews between Shopee, Tokopedia and Lazada, classification with Naïve Bayes Classifier, and determine popularity among Shopee, Tokopedia and Lazada.

a. Number of Shopee, Tokopedia and Lazada Users Reviews

Number of Shopee, Tokopedia and Lazada user reviews shown in Figure. 1.

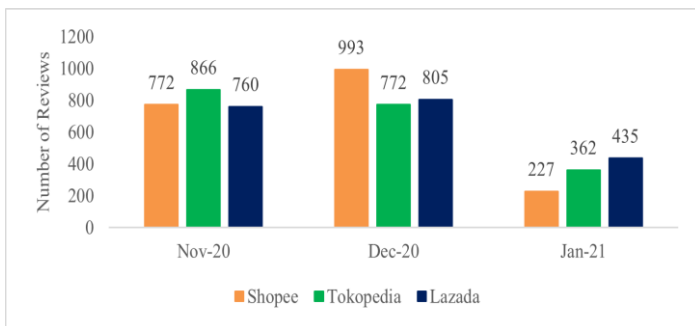

Figure. 1. Number of Shopee, Tokopedia and Lazada User Reviews

Number of Shopee Tokopedia and Lazada reviews in Figure. 1 shows that In November 2020, the highest number of reviews was on Tokopedia with 866 reviews. In December 2020, the highest number of reviews was on Shopee with 933 reviews, In January 2021, the highest number of reviews was Lazada reviews with 435 reviews.

b. Data Preprocessing

Shopee, Tokopedia and Lazada reviews are in the form of unstructured text, so data preprocessing is necessary. The frequency of words that often appear from Shopee reviews is shown in Figure 2.

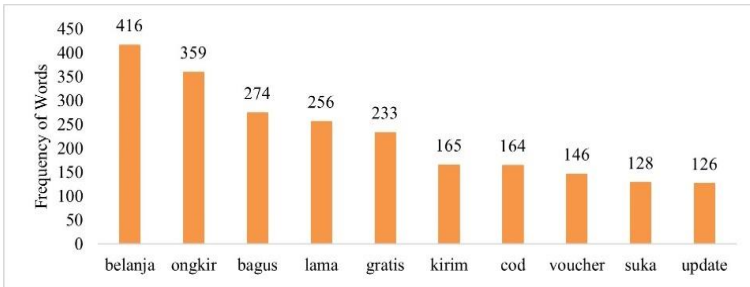

Figure 2. Word Frequency in Shopee Reviews

10 words in Figure 2 that often appear in Shopee reviews are the word ‘belanja/shopping’ which is mentioned 416 times, the word ‘ongkir/postal fee’ is mentioned 359 times, the word ‘bagus/good’ is mentioned 278 times, the word ‘lama/old’ is mentioned 256 times, the word ‘gratis/free’ is mentioned 233 times, the word ‘kirim/send’ is mentioned 165 times, the word ‘cod/cash on delivery’ is mentioned 164 times, the word ‘voucher’ is mentioned 146 times, the word ‘suka/like’ is mentioned 128 times, and the word ‘update’ is mentioned 126 times.

The frequency of words that often appear from Tokopedia reviews is shown in Figure 3.

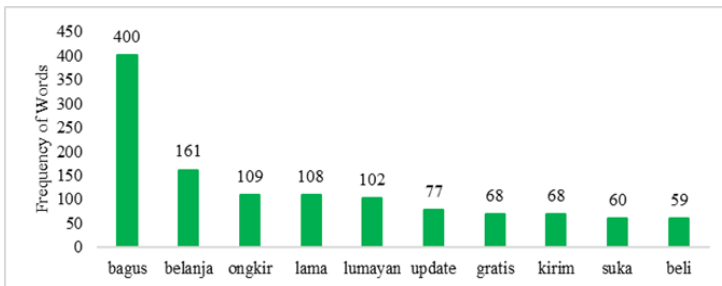

Figure 3. Word Frequency in Tokopedia Reviews

10 words in Figure 3 that often appear in Tokopedia reviews are 'bagus/good' which is mentioned 400 times, the word 'belanja/shopping' is mentioned 161 times, the word 'ongkir/postal fee' is mentioned 109 times, the word 'lama/old' is mentioned 108 times, the word 'lumayan/decent' is mentioned 102 times, the word 'update' is mentioned 77 times, the word 'gratis/free' is mentioned 68 times, the word 'kirim/send' is mentioned 68 times, the word 'suka/like' is mentioned 60 times, and the word 'beli/buy' is mentioned 59 times.

The frequency of words that often appear from Lazada reviews is shown in Figure 4.

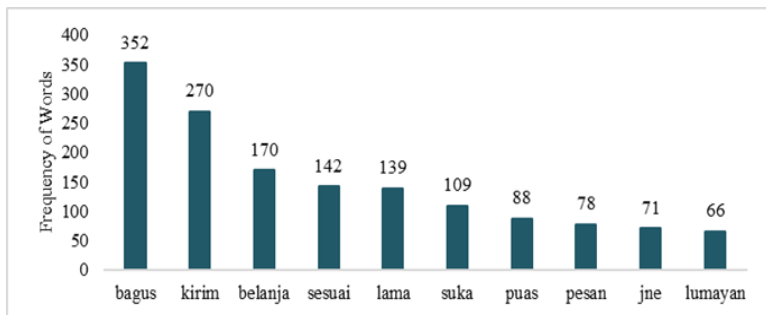

Figure 4. Word Frequency in Lazada Reviews

10 words in Figure 4 that often appear in Lazada reviews are 'bagus/good' which is mentioned 352 times, the word 'kirim/send' is mentioned 270 times, the word 'belanja/shopping' is mentioned 170 times, and the word 'sesuai/appropriate' is mentioned 142 times, the word 'lama/old' is mentioned 139 times, the word 'suka/like' is mentioned 109 times, the word 'puas/satisfied' is mentioned 88 times, the word 'pesan/order' is mentioned 78 times, the word 'jne (Jalur Nugraha Ekakurir)/delivery service' is mentioned times, and the word 'lumayan/decent' is mentioned 66 times.

c. Sentiment Class Labeling

The labeling process is carried out automatically by calculating the value of sentiment labeling using a dictionary that contains a collection of negative words and positive words. Then calculated the score of words that appear in the review using positive minus negative words. The result of sentiment class labeling shown in Table 1.

Table 1. Sentiment Class Labeling

Marketplace	Positive Sentiment	Negative Sentiment
Shopee	1.267	733
Tokopedia	1.394	606
Lazada	1.497	503

The result of sentiment class labeling in Table 1 show that Shopee, Tokopedia and reviews Lazada gets more positive reviews than negative reviews. In Shopee reviews, the proportion of positive reviews with negative reviews tend to be balanced. While in the review Tokopedia and Lazada the proportion of positive reviews with reviews negative tends to be unbalanced.

d. Classification With Naive Bayes Classifier

The data will be divided into training data and test data using 10-fold cross validation. The amount of training data for each Shopee, Tokopedia and Lazada is 1.800 reviews. While the amount of test data for each Shopee, Tokopedia and Lazada is 200 reviews. In this study, the proportion of positive and negative reviews of Shopee tends to be balance so that the measurement of classification accuracy uses accuracy and sensitivity. Meanwhile, the proportion of negative and positive reviews of Tokopedia and Lazada tend to be unbalanced, so the measurement of classification accuracy uses G-Mean and AUC (Area Under Curve). The result of Shopee reviews classification is shown in Table 2.

Table 2. Classification of Shopee Reviews

Iterations	Shopee			
	Training Data (%)		Test Data (%)	
	Accuracy	Sensitivity	Accuracy	Sensitivity
1	85.11	74.55	80.00	67.12
2	84.21	73.33	77.50	63.01
3	84.61	74.09	80.00	68.49
4	83.89	72.27	84.50	73.97
5	84.33	73.03	82.50	69.86
6	83.56	71.82	82.00	64.38
7	84.28	72.73	80.00	71.23
8	84.44	73.90	79.10	62.16
9	83.61	72.23	84.50	72.97
10	83.72	71.47	79.00	62.16
Average	84.18	72.94	80.91	67.54

The result of Shopee reviews classification in Table 2 show that the average accuracy of training data is 84.18%, while the average accuracy of test data is 80.91%. This means that the Naïve Bayes Classifier method is good for classifying Shopee reviews. Based on 10 iterations, the training data classification with the highest accuracy and sensitivity values in iteration 1 was 85.11% and 74.55%, respectively. So that the model with the highest accuracy and sensitivity is obtained, namely at iteration 1. The result of Shopee reviews classification is shown in Table 3.

Table 3. Classification of Tokopedia Reviews

Iterations	Tokopedia			
	Training Data (%)		Test Data (%)	
	G-Mean	AUC	G-Mean	AUC
1	80.60	81.33	71.08	73.2
2	79.37	80.42	82.12	83.09
3	79.5	80.46	82.14	82.83

Iterations	Tokopedia			
	Training Data (%)		Test Data (%)	
4	79.49	80.51	72.2	74.64
5	79.95	80.84	80.22	80.67
6	80.91	81.63	78.01	79.19
7	82.32	82.83	82.06	82.50
8	80.52	81.29	73.1	75.48
9	81.35	81.97	74.89	75.95
10	79.81	80.68	76.96	80.95
Average	80.38	81.19	77.62	78.85

The result of Tokopedia reviews classification in Table 3 show that the average AUC of training data is 81.19%, while the average AUC of test data is 78,85%. This means that the Naïve Bayes Classifier method is good for classifying Tokopedia reviews. Based on 10 iterations, the training data classification with the highest G-Mean and AUC values in iteration 7 was 82.32% and 82.83%, respectively. So that the model with the highest G-Mean and AUC is obtained, namely at iteration 7. The result of Shopee reviews classification shown in Table 4.

Table 4. Classification of Lazada Reviews

Iterations	Lazada			
	Training Data (%)		Test Data (%)	
	G-Mean	AUC	G-Mean	AUC
1	81.10	81.91	77.36	78.33
2	81.32	82.09	79.66	80.67
3	80.85	81.76	82.96	83.11
4	80.30	81.21	82.81	83.33
5	80.72	81.61	82.51	83.00
6	82.08	82.75	70.16	73.33
7	81.07	81.87	82.56	83.33
8	81.61	82.39	78.87	79.61

Iterations	Lazada			
	Training Data (%)		Test Data (%)	
9	80.96	81.80	77.14	78.32
10	80.52	81.40	83.73	84.60
Average	81.05	81.88	79.78	80.76

The result of Lazada reviews classification in Table 4 show that the mean AUC of training data is 81.88%, while the mean AUC of test data is 80.76%. This means that the Naïve Bayes Classifier method is good for classifying Lazada reviews. Based on 10 iterations, the training data classification with the highest G-Mean and AUC values in iteration 6 was 82.75% and 70.16%, respectively. So that the model with the highest G-Mean and AUC is obtained, namely at iteration 6.

e. Determining Marketplace Popularity

The popularity of the marketplace among Shopee, Tokopedia and Lazada is determined from the percentage of positive reviews obtained from Table 1. The popularity of the marketplace among Shopee, Tokopedia and Lazada is shown in Figure. 5.

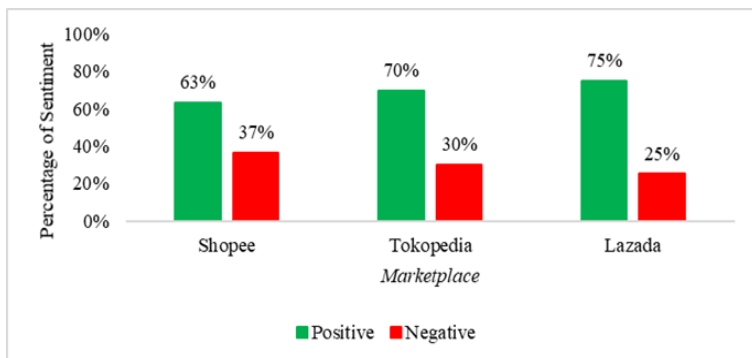

Figure 5. Percentage of Sentiment

The percentage of sentiment in Figure 5 show that the highest percentage of positive sentiment is Lazada at 75%. The second highest percentage of positive sentiment is Tokopedia at 70%. The lowest percentage of positive sentiment is Shopee at 63%. Lazada is the marketplace that gets the most positive sentiment from marketplace users. So Lazada is leading as a marketplace that has the highest popularity compared to Shopee and Tokopedia.

f. Word Cloud

Word cloud visualization to compare positive and negative sentiment reviews. Word cloud visualization of negative and positive Shopee reviews shown in Figure 6.



Figure 6. Word Cloud of Shopee's negative reviews (left) and Shopee's positive reviews (right)

Word cloud of Shopee reviews in Figure 6 shows that the words that often appear in negative reviews of Shopee are 'kirim/send', 'lama/old', and others which mean delivery of old goods. In addition, some users are disappointed in shopping at Shopee which is indicated by smaller words, namely 'belanja/shopping', 'jelek/ugly' and 'kecewa/disappointed'. While the words that often appear in positive reviews of Shopee users are 'bagus/good' and others, which means that some Shopee users are satisfied with shopping at Shopee. In addition, the goods sold at Shopee are in accordance with the orders

indicated by smaller words, namely 'belanja/shopping', 'sesuai/appropriate' and 'kirim/send'.

Word cloud visualization of negative and positive Tokopedia reviews shown in Figure 7.

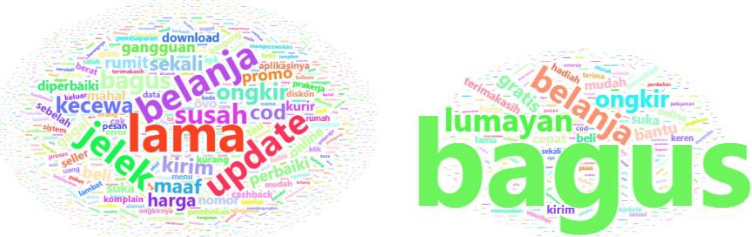

Figure 7. Word Cloud of Tokopedia's negative reviews (left) and Tokopedia's positive reviews (right)

Word cloud of Tokopedia reviews in Figure 7 shows that the words that often appear in negative reviews of Tokopedia users are 'lama/old', 'belanja/shopping', 'jelek/ugly' and others, which means that some Tokopedia users are disappointed in shopping because they are old and ugly. In addition, some Tokopedia users find it difficult to update, which is indicated by smaller words, namely 'update' and 'susah/difficult'. While, the words that often appear in the positive reviews of Tokopedia users are 'bagus/good', 'belanja/shopping', 'lumayan/decent', and others, which means that some Tokopedia users quite like shopping at Tokopedia. In addition, users also like to use free shipping vouchers which are indicated by smaller words, namely 'ongkir/postal fee' and 'gratis/free'.

Word cloud visualization of negative and positive Lazada reviews shown in Figure 8.



Figure 8. Word Cloud of Lazada's negative reviews (left) and Lazada's positive reviews (right)

Word cloud of Lazada reviews in Figure 8 shows that the words that often appear in negative reviews of Lazada users are 'kirim/send', 'lama/old' and others, which means long delivery of goods. In addition, some users are also disappointed shopping at Lazada which is indicated by smaller words, namely 'jelek/ugly' and 'kecewa/disappointed'. While the words that often appear in the positive reviews of Lazada users are 'bagus/good', 'kirim/deliver', 'sesuai/appropriate', 'belanja/shopping' and others, which means that some Lazada users are satisfied with shopping at Lazada because the goods received are appropriate. In addition, ordering goods on Lazada is also fast as indicated by the smaller words, namely 'pesan/order' and 'cepat/fast'.

4 CONCLUSIONS

Based on the results of the analysis and discussion, it was obtained the conclusion is that the highest number of reviews in November 2020 was Tokopedia with 866 reviews. The highest number of reviews in December 2020 was Shopee with 993 reviews. The highest number of reviews in January 2021 was Lazada with 435 reviews.

The result of training data classification in Shopee reviews obtained an average accuracy value of 84.18%, while Tokopedia and Lazada reviews obtained an average AUC value of 81.19% and

81.88%, respectively. The classification of test data in Shopee reviews obtained an average accuracy value of 80.91%, while Tokopedia and Lazada reviews obtained an average AUC value of 78.85% and 80.76%, respectively. So, the Naïve Bayes Classifier obtained is good for classifying Shopee, Tokopedia and Lazada user reviews.

The result of sentiment percentage is that Lazada gets the most positive sentiment compared to Shopee and Tokopedia, with positive sentiment percentages of 75%, 70%, 63%, respectively. Thus, Lazada is leading as a marketplace that has the highest popularity compared to Shopee and Tokopedia.

ACKNOWLEDGEMENTS

Authors would like to thank the Ministry of Research, Technology, and Higher Education of the Republic of Indonesia for supporting this research through Priority Fundamental Research Grant of Institut Teknologi Sepuluh Nopember with the contract number 935/PKS/ITS/2021.

REFERENCES

- [1] Statista, "Number of internet users worldwide from 2005 to 2019," *Statista*, 2019.
- [2] 2019 Hurun Research Institute, "10 Negara dengan Jumlah Unicorn Terbanyak di Dunia (Jun 2019)." .
- [3] E. Flo, "Catat, Ini Kelebihan dan Kekurangan Situs-situs Belanja Online - MerahPutih." p. 1, 2019.
- [4] B. Liu, "Sentiment analysis and opinion mining," *Synth. Lect. Hum. Lang. Technol.*, 2012, doi: 10.2200/S00416ED1V01Y201204HLT016.
- [5] Eko Prasetyo, *Data Mining : Konsep Dan Aplikasi Menggunakan Matlab*. 2013.
- [6] D. Xhemali, C. J. Hinde, and R. G. Stone, "Naive Bayes vs. Decision Trees vs. Neural Networks in the Classification of Training Web Pages," *Int. J. Comput. Sci.*, 2009.

- [7] A.-H. Tan, "Text Mining: The state of the art and the challenges," *Proc. PAKDD 1999 Work. Knowl. Discovery from Adv. Databases*, 1999, doi: 10.1.1.38.7672.
- [8] Z. A. N. Gumilang, "Implementasi Naïve Bayes Classifier Dan Asosiasi Untuk Analisis Sentimen Data Ulasan Aplikasi E-Commerce Shopee Pada Situs Google Play," *Isbn*, 2018.
- [9] R. Kohavi, "A Study of Cross-Validation and Bootstrap for Accuracy Estimation and Model Selection," *Int. Jt. Conf. Artif. Intell.*, 1995.
- [10] T. R. Patil, "Performance Analysis of Naive Bayes and J48 Classification Algorithm for Data Classification," *Int. J. Comput. Sci. Appl. ISSN 0974-1011*, 2013.
- [11] T. Pang-Ning, M. Steinbach, and V. Kumar, "Introduction to data mining: Solution Manual," *Libr. Congr.*, 2006.
- [12] A. Hotho, A. Nürnberger, and G. Paaß, "A Brief Survey of Text Mining," *LDV Forum - Gld. J. Comput. Linguist. Lang. Technol.*, 2005, doi: 10.1111/j.1365-2621.1978.tb09773.x.
- [13] Y. Sun, M. S. Kamel, and Y. Wang, "Boosting for learning multiple classes with imbalances class distribution," 2006, doi: 10.1109/ICDM.2006.29.
- [14] Q. Castellà and C. Sutton, "Word storms: Multiples of word clouds for visual comparison of documents," 2014, doi: 10.1145/2566486.2567977.
- [15] F. K. Wardani, V. R. Hananto, and V. Nurcahyawati, "Analisis Sentimen Untuk Peningkatan Popularitas Situs Belanja Online Di Indonesia Menggunakan Metode Naive Bayes (Studi Kasus Data Sekunder)," *Jsika*, 2019.
- [16] M. Murnawan, "PEMANFAATAN ANALISIS SENTIMEN UNTUK PEMERINGKATAN POPULARITAS TUJUAN WISATA," *J. Penelit. Pos dan Inform.*, 2017, doi: 10.17933/jppi.2017.070203.
- [17] W. Wibowo, N. P. Sari, R. N. Wilantari, and S. Abdul-Rahman, "Association rule mining method for the identification of internet use," *J. Phys. Conf. Ser.*, vol. 1874, no. 1, p. 012009, 2021, doi: 10.1088/1742-6596/1874/1/012009.

IMPLEMENTATION OF TOPIC MODELLING WITH LATENT DIRICHLET ALLOCATION (LDA) ON THE JUDGE'S DECISION

Hanipar Mahyulis Sastriana¹, Wiwit Pura Nurmayanti²,
Lukmanul Hakim³

^{1,2,3}*Universitas Hamzanwadi (INDONESIA)*
haniparmahyulis04@gmail.com

Abstract

Indonesia is one of the countries with the fourth largest population after Tiongkok, India and America. With a large population, Indonesia has a high crime rate. Of the 34 provinces in Indonesia, NTB is ranked 14th with the highest crime. Every crime that occurs will be tried in a district court and ends in the form of a judge's decision. This study aims to determine the topics that formed based on data text from the judge's decision letter, and general description of judge's decision data. Data used in this research is the judge's decision letter in 2015-2020. Based on the results of the analysis using the Latent Dirichlet Allocation (LDA) method, it was found that the perpetrators of crime are dominated by male gender by 92%, and 8% for female gender. The results of the implementation of topic modelling with Latent Dirichlet Allocation (LDA) resulted in 4 topics. The first topic discusses the crime of theft with violence, the second topic discusses the crime of theft by weighting, the third topic discusses ordinary theft crimes, and the last topic covers gambling case.

Keywords: West Nusa Tenggara (NTB), Judge's Decision Letter, Topic Modelling, Latent Dirichlet Allocation (LDA).

1 INTRODUCTION

Indonesia is one of the countries with the fourth largest population after China, India, and America [1]. Indonesia also has a population that is predominantly Muslim, in which Islam does not only regulate matters of faith and worship, but Islam also provides the main basis

for norms or rules in carrying out life. In the context of national law in Indonesia, in article 1 paragraph 3 of the 1945 Constitution of the Republic of Indonesia through the third amendment to the 1945 Constitution of the Republic of Indonesia, which states that the state of Indonesia is a state of law [2]. The rule of law is a state that bases every state life on a clear and firm mechanism [3]. As a state of law, Indonesia must be able to guarantee and prioritize the principle of equality for everyone before the law (Equality Before the Law) [4]. With a large population, Indonesia has a high crime rate. Crime that occurs in society is a behavior that violates the rules. Behavior that violates the rules is a threat to social rules that can disrupt social order [5].

According to the mid-2020 Numbeo index, which tracks crime rates in countries around the world. Indonesia is ranked 58th in the crime index, and for a country with a state security index, Indonesia is ranked 76th, far different from other Southeast Asian countries including Berunei, Singapore, Thailand, and the Philippines [6]. Of the 34 provinces in Indonesia, the province of West Nusa Tenggara ranks 14th with the highest crime rate of 8,132 crimes [7]. With the largest population among districts/cities in the province of NTB, East Lombok Regency has a Class 1B Selong District Court in resolving crimes that have occurred.

In order to reduce the level of crime in the community, various methods have been carried out, one of the ways to reduce crime is criminal application or the application of criminal law, for example criminal law with sanctions in the form of crimes listed in the Criminal Code article 10 [8], and socialization of the dangers of crime by the government. Every crime that occurs in the area of East Lombok and its surroundings will be tried or the case will enter the Selong District Court Class 1b. In this case, the judiciary is a state institution whose main task is to examine, try, decide, and resolve crimes that enter the court. The process of resolving crimes through the judiciary will run well if it follows the existing rules in an honest and orderly manner [9]. The aspect of punishment is the final peak of the problems of the criminal justice system with the verdict of the judge [10]. There are still

many decisions issued by judges in this matter that the general public cannot understand. Based on these problems, the researcher wants to help the general public or readers to better understand the judge's decision letter. The importance of conducting this research is to inform the judge's decision in the Selong District Court Class 1b.

One of the methods used in analyzing text data such as data from a judge's decision on a case is using topic modeling analysis. Topic Modeling is a popular statistical analysis method used to extract and find hidden topics in a document [11],[12]. Topics consisting of a set of words that can describe the topic, and in one document each of the several topics produced [13]. With topic modeling, you can find out what topics often appear in a document under study. In analyzing topic modeling, researchers used the Latent Dirichlet Allocation (LDA) method. The most popular method for topic modeling is Latent Dirichlet Allocation (LDA) by Blei and Jordan which is a generative probability model to determine the semantic structure of a discrete data set such as a corpus [14], [15]. LDA considers that every document consists of several topics and each topic consists of several words, therefore a document can contain several different topics [16]. Latent Dirichlet allocation is a text analysis method, especially large amounts of text data [17].

Using topic modeling analysis with the latent dirichlet allocation (Lda) algorithm, it can be seen what topics often appear in judges' decisions and can make it easier to understand what topics often arise in criminal cases in the Selong District Court Class 1B, East Lombok Regency.

2 METHODOLOGY

This research was conducted at the Selong District Court Class 1B. The time of the research began on February 11, 2021. The type of data used in this study was secondary data, namely data on the decisions of judges in criminal cases in the Selong District Court Class 1B. Data obtained through the website page of the Selong District Court Judge Decision Directory Class 1B. In this research, the author

uses the help of Excel 2016 and R Studio software in the data analysis process. The method used in this research is descriptive analysis method and Topic Modeling method using Latent Dirichlet Allocation (LDA).

The stages of analysis in this study are, as follows:

1. Descriptive analysis which aims to describe the characteristics of the decision data of the Selong District Court judges.
2. Latent Dirichlet Allocation (LDA) analysis with the initial stage of inputting data into the R Studio software.
3. Calling the package, it takes packages tm, wordcloud, topicmodels, tidytext, ggplot2, dplyr, and tidyr in the topic modeling analysis process with Latent Dirichlet Allocation (LDA).
4. Data cleaning or data cleaning process, the data cleaning stage is carried out so that the data can be further analyzed in text mining analysis using Latent Dirichlet Allocation (LDA) such as:
 - a) Convert text data from uppercase to lowercase,
 - b) Eliminate numbers in text data,
 - c) Eliminate stop words, words that often appear but have no meaning,
 - d) Eliminate punctuation characters in the judge's decision text data.
5. Topic modeling uses Latent Dirichlet Allocation (LDA), with LDA punction, and determines the number of topics formed.
6. Visualization of topics formed with the ggplot view.

3 RESULTS

a. Descriptive Analysis

i. Percentage of gender offenders

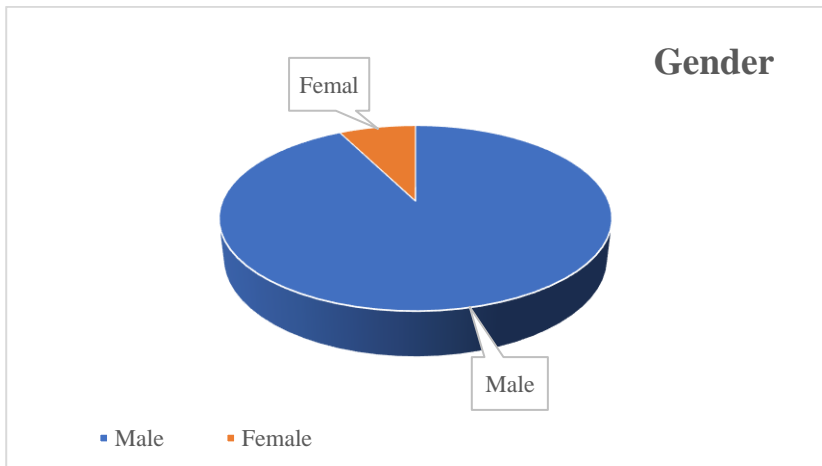

Figure 1. Gender Percentage

Figure 1 shows the percentage of gender who committed a crime in the Selong District Court Class 1b in 2015-2020. Of the 293 cases, 92% were male, 8% or 22 people were female. In everyday life, it can be seen that most of the perpetrators of crime are committed by men and not even many women commit crimes. This can be caused by several things, namely physically women are less strong, and protected by the environment because of the workplace, at home, and women drinking less alcohol [18].

Crime is inherited, criminal families will tend to produce criminal children. People tend to commit crimes with low self-control, courageous, strong people, more power, extraverts, tend to be assertive, the drive to fulfill needs is very high [19].

ii. Number of criminal cases

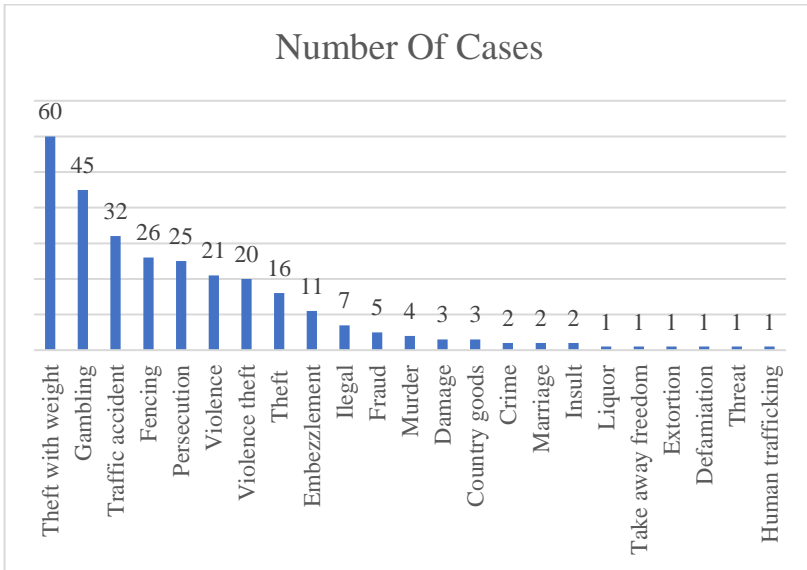

Figure 2. Number of Ordinary Criminal Cases

Figure 2 describes the number of ordinary criminal cases in the judge's decision letter at the Selong District Court Class 1b in 2015-2020. It can be seen that cases of theft with weighting are the highest cases with 60 cases, followed

by gambling cases as many as 45 cases, traffic accidents as many as 32 cases, and the lowest cases are liquor, take away freedom, defamation, threats, and human trafficking.

During the period 2011-2018, the type of theft crime was the most common crime in villages or ward in Indonesia [20]. The factors that cause the crime of theft are education, economy, environment, social and it is necessary to know that there is something more fundamental to the occurrence of a crime, namely the opportunity [21].

iii. *Number of Cases in 2016-2020*

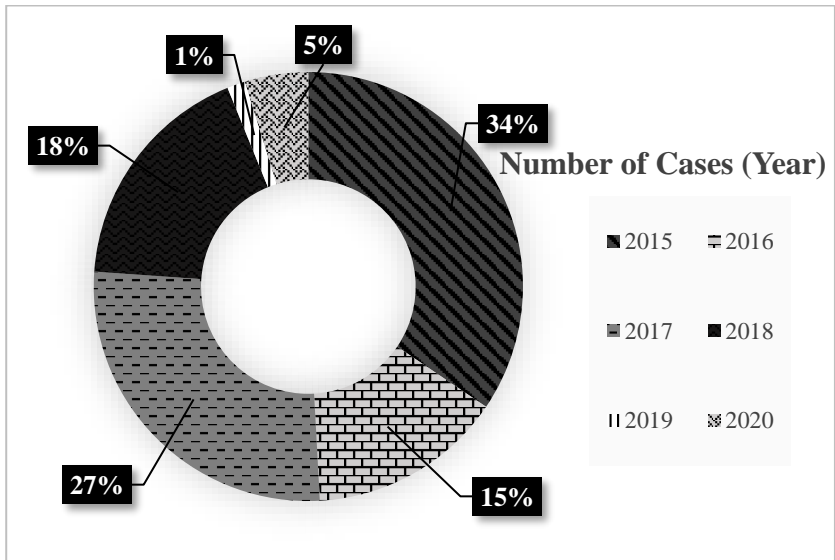

Figure 3. *Number of Cases*

Figure 3 shows the number of criminal cases that went to the Selong District Court Class 1b in 2015-2020. It can be seen that 2015 with 34% was the year in which the highest number of cases went to the Selong District Court Class 1b with 101 criminal cases. The year 2017 with 27% became the second highest year with 79 incoming cases. And the lowest number of cases was 1% of cases in 2019.

b. Data Preprocessing

In text mining data analysis, it is necessary to clean text data or what is often referred to as text data cleaning (preprocessing data). The text data cleaning stage aims to eliminate or clean text data that is not needed in the next analysis stage. The following is the initial data on the decision of the Selong District Court Judge Class 1b:

Table 1. Initial Data of Decisions

Decision
MENGADILI1. Menyatakan Terdakwa ZAENUDIN Alias UDIN Alias AMAQ ASKA terbukti secara sah dan meyakinkan bersalah melakukan tindak pidana Pencurian ;2. Menjatuhkan pidana terhadap Terdakwa tersebut dengan pidana penjara selama 6 (enam) bulan ;3. Menetapkan lamanya Terdakwa berada dalam tahanan dikurangkan seluruhnya dari pidana yang dijatuhkan ;4. Menetapkan agar Terdakwa tetap berada dalam tahanan ;5. Menetapkan barang bukti berupa :- 1(satu) buah karung beras berwarna putih ukuran 50 Kg (lima puluh kilogram);- 19 Kg (sembilan belas kilogram) cabai rawit jenis Dewata ;Dikembalikan kepada pemiliknya yaitu saksi H. Abdul Azis ;6. Membebaskan kepada Terdakwa untuk membayar biaya perkara sebesar Rp 2.500,-(dua ribu lima ratus rupiah)

Table 1 is the initial data before cleaning the text data. In cleaning text data for text mining analysis, it is necessary to carry out the stages of lower casing, remove punctuation, stopword removal, and remove numbers.

iv. Lower Case

lower case aims to convert (transformer to lower) capital letters into lowercase letters, so that all text data becomes data with lowercase text.

Table 2. Lower Casing Results.

Before	After
MENGADILI1. Menyatakan Terdakwa ZAENUDIN Alias UDIN Alias AMAQ ASKA terbukti secara sah dan meyakinkan bersalah melakukan tindak pidana	mengadili1. menyatakan terdakwa zaenudin alias udin alias amaq aska terbukti secara sah dan meyakinkan bersalah melakukan tindak pidana pencurian ;2. menjatuhkan

Before	After
<p><u>P</u>encurian ;2. <u>M</u>enjatuhkan pidana terhadap <u>T</u>erdakwa tersebut dengan pidana penjara selama 6 (enam) bulan ;3. <u>M</u>enetapkan lamanya <u>T</u>erdakwa berada dalam tahanan dikurangkan seluruhnya dari pidana yang dijatuhkan ;4. <u>M</u>enetapkan agar <u>T</u>erdakwa tetap berada dalam tahanan ;5. <u>M</u>enetapkan barang bukti berupa :- 1(satu) buah karung beras berwarna putih ukuran 50 <u>K</u>g (lima puluh kilogram);- 19 <u>K</u>g (sembilan belas kilogram) cabai rawit jenis <u>D</u>ewata ;<u>D</u>ikembalikan kepada pemiliknya yaitu saksi <u>H</u>. <u>A</u>bdul <u>A</u>zis ;6. <u>M</u>embebankan kepada <u>T</u>erdakwa untuk membayar biaya perkara sebesar <u>R</u>p 2.500,-(dua ribu lima ratus rupiah)</p>	<p>pidana terhadap <u>t</u>erdakwa tersebut dengan pidana penjara selama 6 (enam) bulan ;3. <u>m</u>enetapkan lamanya <u>t</u>erdakwa berada dalam tahanan dikurangkan seluruhnya dari pidana yang dijatuhkan ;4. <u>m</u>enetapkan agar terdakwa tetap berada dalam tahanan ;5. <u>m</u>enetapkan barang bukti berupa :- 1(satu) buah karung beras berwarna putih ukuran 50 kg (lima puluh kilogram);- 19 <u>kg</u> (sembilan belas kilogram) cabai rawit jenis <u>d</u>ewata ;<u>d</u>ikembalikan kepada pemiliknya yaitu saksi <u>h</u>. <u>abdul azis</u> ;6. <u>m</u>embebankan kepada <u>t</u>erdakwa untuk membayar biaya perkara sebesar <u>rp</u> 2.500,-(dua ribu lima ratus rupiah)</p>

v. *Remove Numbers*

Remove numbers aims to eliminate numbers contained in text data, as shown in the following table:

Table 3. Results of Remove Numbers

Before	After
<p><u>1</u>. menyatakan terdakwa zaenudin alias udin alias amaq aska terbukti secara sah dan</p>	<p>menyatakan terdakwa zaenudin alia udin alia amaq aska terbukti secara sah dan meyakinkan</p>

Before	After
<p>meyakinkan bersalah melakukan tindak pidana pencurian ;<u>2.</u> menjatuhkan pidana terhadap terdakwa tersebut dengan pidana penjara selama <u>6</u> (enam) bulan ;<u>3.</u> menetapkan lamanya terdakwa berada dalam tahanan dikurangkan seluruhnya dari pidana yang dijatuhkan ;<u>4.</u> menetapkan agar terdakwa tetap berada dalam tahanan ;<u>5.</u> menetapkan barang bukti berupa :- <u>1</u>(satu) buah karung beras berwarna putih ukuran <u>50</u> kg (lima puluh kilogram);- <u>19</u> kg (sembilan belas kilogram) cabai rawit jenis dewata ;dikembalikan kepada pemiliknya yaitu saksi h. abdul azis ;<u>6.</u> membebaskan kepada terdakwa untuk membayar biaya perkara sebesar rp <u>2.500.</u>-(dua ribu lima ratus rupiah)</p>	<p>bersalah melakukan tindak pidana pencurian ;. menjatuhkan pidana terhadap terdakwa tersebut dengan pidana penjara selama (enam) bulan ;. menetapkan lamanya terdakwa berada dalam tahanan dikurangkan seluruhnya dari pidana yang dijatuhkan ;. menetapkan agar terdakwa tetap berada dalam tahanan ;. menetapkan barang bukti berupa :- (satu) buah karung bera berwarna putih ukuran kg (lima puluh kilogram);- kg (sembilan bela kilogram) cabai rawit jeni dewata ;dikembalikan kepada pemiliknya yaitu saksi h. abdul azis ;. membebaskan kepada terdakwa untuk membayar biaya perkara sebesar rp .,-(dua ribu lima ratus rupiah)</p>

vi. Stopword Removal

Stopword removal aims to remove words that often appear but have no meaning. Examples of stopword words in Indonesian are: "di", "telah", "dan", "atau", "yang", "dengan", "untuk", and others. The results of stopword removal are as follows:

Table 4. Stopword Removal Results

Before	After
<p>menyatakan terdakwa zaenudin alia udin alia amaq aska terbukti secara sah dan meyakinkan bersalah melakukan tindak pidana pencurian ;. menjatuhkan pidana terhadap terdakwa tersebut dengan pidana penjara selama (enam) bulan ;. menetapkan lamanya terdakwa berada dalam tahanan dikurangkan seluruhnya dari pidana yang dijatuhkan ;. menetapkan agar terdakwa tetap berada dalam tahanan ;. menetapkan barang bukti berupa :- (satu) buah karung bera berwarna putih ukuran kg (lima puluh kilogram);- kg (sembilan bela kilogram) cabai rawit jeni dewata ;dikembalikan kepada pemiliknya yaitu saksi h. abdul azi ;. membebaskan kepada terdakwa untuk membayar biaya perkara sebesar rp .,-(dua ribu lima ratus rupiah)</p>	<p>zaenudin udin aska pencurian ;. lamanya dikurangkan dijatuhkan ;. ;. :- () buah karung beras berwarna putih ukuran ;- cabai rawit jenis dewata ; saksi h. abdul azi.,-</p>

vii. Remove Punctuation

Remove punctuation aims to remove punctuation characters such as periods, commas, colons, equals, and so on. The results of remove punctuation are as follows:

Table 5. Results of Remove Punctuation

Before	After
zaenudin udin aska	zaenudin udin aska
pencurian :((enam) :	pencurian lamanya
lamanya dikurangkan	dikurangkan dijatuhkan
dijatuhkan : : :- () buah	buah karung beras berwarna
karung bera berwarna putih	putih ukuran cabai rawit jenis
ukuran kg (puluh kilogram):- kg	dewata saksi h abdul azi
(sembilan bela kilogram) cabai	
rawit jeni dewata : saksi h.	
abdul azi : rp :- (ribu)	

c. Latent Dirichlet Allocation (LDA)

Analysis of topic modeling aims to see the topics formed from the collected text data, by looking at the output or visualization that is produced, and concludes it into a particular topic. The following is the output of topic modeling with latent dirichlate allocation (LDA):

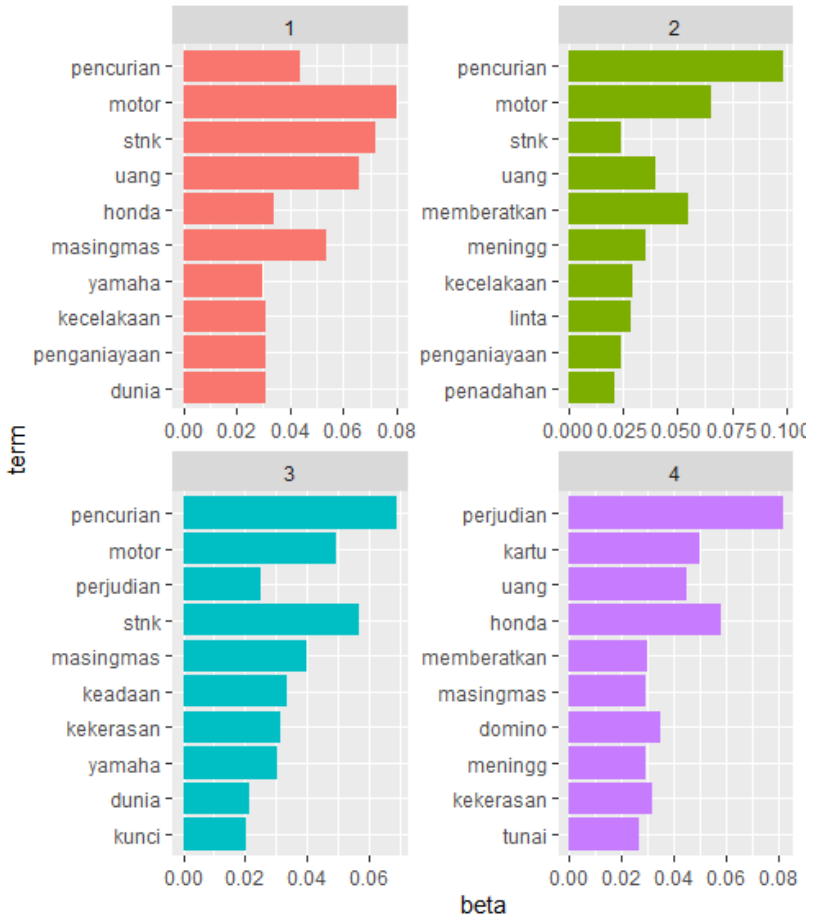

Figure 4. General Topics

The visualization above helps to understand the 4 topics extracted from the judge's decision letter at the Selong District Court Class 1b. the most common words in topic 1 include "pencurian", "motor", "stnk", "uang", "penganiayaan", indicating that it may represent a case of violent theft. Topic 2 includes "pencurian", "motor", "memberatkan",

which indicates that this second topic represents a theft case by weight. Topic 3 includes “pencurian”, “stnk”, “kunci”, which can represent ordinary theft cases. While the 4th topic includes “perjudian”, “kartu”, “uang”, “domino”, “honda”, which can represent a gambling crime.

4 CONCLUSIONS

General description of the data on ordinary cases at the Selong District Court Class 1B in 2015-2020, namely the highest crimes committed by male defendants with a size of 92%, and 8% for female gender. Cases of theft with weighting is the highest case with 60 cases that occurred, the second highest case is gambling with 45 cases, and the lowest cases are liquor, defamation, and other. 2015 was the year with the highest number of cases that went to court with 101 cases. The implementation of topic modeling with latent dirichlet allocation resulted in 4 topics. Topic 1 tends to discuss criminal theft with violence, topic 2 represents cases of theft by weight, topic 3 discusses ordinary theft, and topic 4 covers gambling cases.

Further research examines more sources of theory and understands topic modeling methods using latent dirichlet allocation and also develops other topic modeling methods. Subsequent research uses different case studies with more complete and more complete data, and uses a more in-depth topic modeling method.

REFERENCES

- [1] Databoks, Jumlah Penduduk Indonesia 269 Juta Jiwa, Terbesar Keempat di Dunia, 2019.
- [2] Aidul Fitriadi Azha, Negara Hukum Indonesia: Dekolonisasi dan Rekonstruksi Tradisi, *Jurnal Jus Quia Iustum*, 19(4), h. 490, 2012.
- [3] Jenpatar Simamora, Tafsir Negara Hukum dalam Perspektif Undang-Undang Dasar Negara Republik Indonesia Tahun 1945, *Jurnal Dinamika Hukum*, 14(3), h. 72, 2014.
- [4] Asshidiqie, dkk, Membangun Konstitusional Indonesia, *Jurnal Konstitusi* 2(4):2-203, 2006.

- [5] Wibowo, A, Statistik Politik dan Keamanan Daerah Istimewa Yogyakarta 2018, Yogyakarta: Badan Pusat Statistik Provinsi Daerah Istimewa Yogyakarta, 2019.
- [6] Asmardika, R. (2020). Qatar Negara Teraman di Dunia Pertengahan 2020, Indonesia Peringkat 76. Diakses pada 1 Agustus 2021, dari <https://www.google.com/amp/s/news.okezone.com/amp/2020/07/15/18/2246625/qatar-negara-teraman-di-dunia-pertengahan-2020-indonesia-peringkat-76>
- [7] BPS, 2018.
- [8] Barda Nawawi Arif, Beberapa Aspek Kebijakan Penegakkan Hukum dan Pengembangan Hukum Pidana, Citra Aditya Bakti, 2005, h. 2.
- [9] Jerol Vandrixton Lintogareng, Analisis Keyakinan Hakim Dalam Pengambilan Keputusan Perkara Pidana Di Pengadilan, Lex Crimen, 3(2), h.24, 2013.
- [10] Lilik Mulyadi, (2006). Pergeseran Perspektif dan Praktik dari Mahkamah Agung Republik Indonesia Mengenai Putusan Pemidanaan, Majalah Varia Peradilan, h. 1.
- [11] D. M. Blei, "Probabilistic topic models", Commun ACM, vol. 55, no. 4, p. 77, Apr. 2012.
- [12] Sammut, C., and Webb, G. I., Encyclopedia of Mechine Learning and Data Mining . (2nd ed), New York : Springer Science+Business Media, 2017.
- [13] Putra, I. M., dan Kusumawardani, R. P, Analisis Topik Informasi Publik Media Sosial di Surabaya Menggunakan Pemodelan Latent Dirichlet Allocation (LDA), Surabaya : Institut Teknologi Sepuluh November, 2017.
- [14] J. C. L. Pinto and T. Chahed, "Modeling multi-topic information diffusion in social networks using latent dirichlet allocation and hawkes processes", Proc.-10th Int. Conf. Signal-Image Technol. Internet-Based Syst. SITIS 2014, pp.339-346, 2015.
- [15] D. M. Blei et al., "Latent Dirichlet Allocation Journal of Machine Learning Research, 993-1022, 2003.

- [16] Silge, J., and Robinson, D., Text Mining with R : A Tidy Approach (1st ed), New York :O'Reilly Media.
- [17] Bird, C., Menzie, T., and Zimmermann, T. 2015. The Art and Science of Analyzing Software Data (1st ed.). Waltham: Elsevier Inc.
- [18] Hurwitz, Stephan, Penelitian Kualitatif Dasar-dasar dan Aplikasi, YA3, Malang, 1986.
- [19] Thahir, Andi, Psikologi Kriminal, Bandung, 2016.
- [20] BPS, Statistik Kriminal 2020, Badan Pusat Statistik, 2020.
- [21] Magrhobi, Berdy Despar, Tinjauan Kriminologis Faktor Penyebab Terjadinya Tindak Pidana Pencurian Kendaraan Bermotor, Malang: Fakultas Hukum Universitas Brawijaya, 2014.

COMPARATIVE ANALYSIS OF CLASSIFIER FOR BRI CUSTOMERS PATTERN PREDICTION USING NAIVE BAYES, KNN AND RANDOM FOREST

Atria¹, Wiwit Pura Nurmayanti², Umam Hidayaturohman³,
Ristu Haiban Hirzi⁴

^{1,2,3,4} *Hamzanwadi University (INDONESIA)*
atrianala23@gmail.com

Abstract

Analysis is a data processing technique that divides objects into several classes according to the desired number of classes Naïve Bayes, K-Nearest Neighbor and Random Forest are some of the methods contained in the classification analysis. Naïve Bayes aims to predict the probability of a class, K-Nearest Neighbors is a method that works by finding groups of k objects in the training data that are closest (similar) to the object in the testing data, while random forest is one of the ensemble method where the randomization process is not only carried out on sample data but also on independent variables. Credit data is data about customers who make loans to the Bank. Giving credit in an inappropriate way can lead to credit risk such as bad credit. To minimize the risk of increasing bad loans, information regarding bad and current loans is very important for the Bank. General objective of this research is to classify non-performing and current loans, while the specific objective is to find out the best method of lending at the BRI based on accuracy, sensitivity and specificity values. The data used in this study is BRI Bank Sikur Unit Customer data in 2020-2021 where there are 4 databases, namely gender, ceiling, collectability and flag rest. Based on the results of the Naive Bayes, K-Nearest Neighbor and Random Forest analysis, it was found that the Random Forest method was superior with 96.15% accuracy, 95.65% sensitivity and 1% specificity compared to Naïve Bayes, K-Nearest Neighbors. Keywords: Credit, Classification Analysis, Naive Bayes, K-Nearest Neighbor and Random Forest.

1 INTRODUCTION

Bank BRI is one of the private banks that accepts deposits and distributes them to the public, one of which is in the form of credit [1]. According to Hasibuan [2] Credit is the provision of money or bills that must be repaid with interest by the borrower in accordance with the agreed agreement. Giving credit in an inappropriate way can cause credit risks such as bad credit, bad credit is a condition where debtors, whether individuals or companies, are unable to pay bank loans on time [3] or in other words bad credit is also a condition. where the customer is no longer able to pay part or all of the obligations to the bank that has been agreed [4]. To overcome the problem of bad credit, data mining is needed which is the process of automatically searching for useful information in large data storage areas [5] or the mining process of discovering new information by looking for certain patterns from very large amounts of data [6]. Data mining has various functions, one of which is a classification function.

Classification analysis is a data processing technique that divides objects into several classes according to the desired number of classes [7]. Naïve Bayes, K-Nearest Neighbor and Random Forest are some of the methods contained in the classification analysis. The Naive Bayes method itself is a simple classification algorithm where this method calculates a collection of probabilities by adding up the frequency and combination of values from a given dataset [8]. While the K-Nearest Neighbor method is one of the non-parametric methods used in classification where this method works by looking at k objects based on the training data that is the closest distance [9] or a method that looks at the majority class which is used as predictive data from test data [10].

Affaturahman AD [13] in his research on the comparison of the nave Bayes method and the k-nearest neighbor using metric accuracy, sensitivity and specificity parameters on the intrusion detection system (IDS) where the results of the comparison of the two methods show that the k-nearest neighbor gets a higher value with Accuracy value is 99.53%, sensitivity is 94.05 and specificity is

75.20%. Annisa R [14] in decision tree research, nave bayes, k-nearest neighbors and random forests are accurately applied in predicting heart disease sufferers, the results of this study indicate that the random forest algorithm produces the best accuracy rate of 80.38%, decision tree and nave bayes perform the best performance in classifying datasets while K-Nearest neighbor is not well implemented in datasets.

Based on the background described above, this study was conducted to apply data mining using the nave Bayes method, k-nearest neighbor and random forest in order to predict and classify customer patterns at the BRI Bank Sikur unit in 2020-2021.

2 METHODOLOGY

This research was conducted at Bank BRI Sikur unit. The time of the research began on February 11, 2021. The type of data used in this study was secondary data, namely loan data at the BRI bank Sikur unit. The analysis used is a classification analysis using the nave Bayes method, k-nearest neighbor and random forest which is a technique to find a pattern that is able to separate data classes from one another to determine objects that fall into certain categories [15]. *Where this research uses the help of software R Studio and Ms. excel in data analysis.*

2.1 Analysis Stage

2.1.1. Naive Bayes

There are several steps this calculation process [16]

1. Calculate probability for each class
2. Calculate likelihood probability
3. Calculate the highest probability of the distribution's aspect and sentiment.

In this stage we calculate for each class category using the formula: $P(V_j)^{P(V_j)}$

$$P(V_j)^{P(V_j)} = \frac{fd(P(V_j))}{|D|} \frac{|fd(P(V_j))|}{|D|}$$

Where is the number of words in the category j and D is the number of documents used in training. Next, we calculate $fd(P(V_j))^{fd(P(V_j))} P(V_j)$

for each in the vocabulary with formula : $W_k | V_j) W_k | V_j) W_k | V_j)$

$$P(W_k | V_j) = \frac{f(P(W_k | V_j)) + 1}{N + |W|}$$

Where P is the amount of occurrences of words in the category , N is the amount of all words in the category and w is the number of unique words (distinct) on all training data. $W_k | V_j) W_k | V_j) W_k | V_j)$

2.1.2 K-Nearest Neighbor

This algorithm functions as follows [17]

1. Compute Euclidean or mahalanobis distance from target plot to those that were sampled.
2. Orders samples taking for account calculated distance.
3. Choose heuristically optimal k nearest neighbor based on RMSE done by cross validation technique.
4. Calculate an inverse distance weighted average with the k-nearest multivariate neighbor

2.1.3 Random Forest

Steps in working of random forest classifier are as follows [18]

1. Select any number of random data points from training dataset.
2. Build decision tree for selected data points.
3. Take input N from user that is number of decision trees which will be implemented by random forest classifier.
4. Repeat step 1 and 2 (N-1) no of times
5. Take output from each decision tree and put new data point into maximum voted category

3 RESULTS

3.1 Descriptive Analysis



Figure 1. Descriptive gender

Figure 1 shows the gender of those who make loans at the BRI Unit Sikur bank in 2020-2021 from 207 debtors, 34% are female and 66% are male. In other banks, women usually have experience and lower incomes than male entrepreneurs so that the assets and sales they have are also lower, therefore when applying for credit funds to the bank, they will experience difficulties because they are considered inadequate [19].

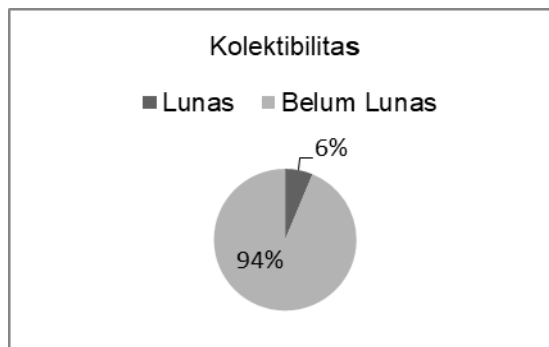

Figure 2. Descriptive collectability

Figure 2 shows the total percentage of collectibility at the BRI Unit Sikur bank in 2020-2021. Where the percentage of collectibility of 207 debtors is 6% paid off and 94% has not been paid off

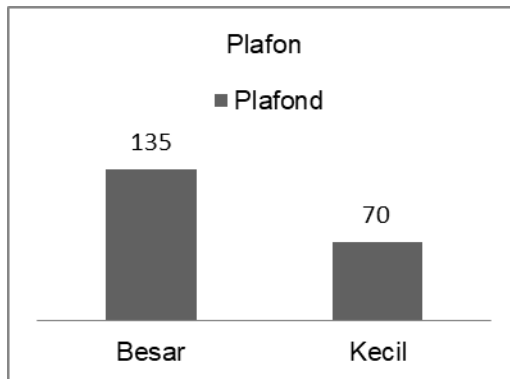

Figure 3. Descriptive ceiling

Figure 3 states that the BRI Unit Sikur bank in 2020-2021 has 2 criteria for the large number of loans, namely the small class with a loan range of 1 million — 25 million, while the large class from 26 million -100 million and above. From 207 debtors, there are 135 debtors who borrowed loans in the criteria of large loans and the remaining 70 debtors were in small class loans where the loan range was 1 million — 25 million.

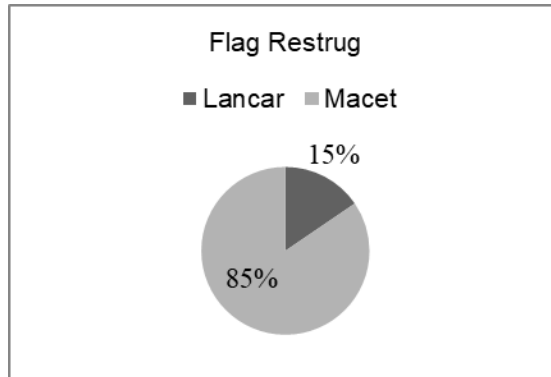

Figure 4. Descriptive Flag restrug

In Figure 4 there are two classes of restructuring flags, namely the jammed class and the current class, the bad class is the condition or condition of the debtor who has not paid the bill for 9 months while the current class is the condition of the debtor who pays the bill according to the time agreed by both parties [21]. The percentage of flag restrugs from 207 debtors is 15% of borrowers in the bad class and 85% in the current class.

3.2 Classification Analysis

3.2.1 Naive Bayes

Table 1. Output Nave Bayes

Score	Fluent	Congested
Prediction	43	5
Accuracy	92.31%	
Sensitivity	93.48%	
Specificity		83.33%

Based on Table 1, there are two classification classes on customer loan data at the BRI Bank Sikur unit, namely the current and non-performing classes. There are three values to find the best

method, namely accuracy, sensitivity and specificity [22]. The sensitivity value is the value of the accuracy of the system between the information provided by the system to correctly show negative class data or positive class, while the specificity value is a value that indicates the level of success to find out correctly information about data that is negative class or positive class for accuracy values. used to see the level of closeness between the predicted value of the system and the predicted value of humans in the test (22). The Naive Bayes method displays the classification results with the prediction results for the current class of 43 and the non-performing class of 5.

3.2.2 *K-Nearest Neighbor.*

Table 2. Output K-Nearest Neighbor

Score	Fluent	Congested
Prediction	46	0
<i>Accuracy</i>	88.46%	
<i>Sensitivity</i>	1%	
<i>Specificity</i>		0%

Based on Table 2, there are three values to find the best method, namely accuracy, sensitivity and specificity (22). The sensitivity value is the value of the accuracy of the system between the information provided by the system to correctly show negative class data or positive class, while the specificity value is a value that indicates the level of success to find out correctly information about data that is negative class or positive class for accuracy values. used to see the level of closeness between the predicted value of the system and the predicted value of humans in the test (22). K-Nearest Neighbor displays the classification results on the K-Nearest Neighbor method. K-Nearest Neighbor with $k=9$ is able to predict current class of 46 and jammed 0. Accuracy value is 88.46%, sensitivity (1% and 0%). .

3.2.3 *Random Forest*

Table 3. Random Forest Output

Score	Fluent	Congested
Prediction	44	6
<i>Accuracy</i>	96.15%	
<i>Sensitivity</i>	95.65%	
<i>Specificity</i>		1%

Based on Table 3, there are three values to find the best method, namely accuracy, sensitivity and specificity (22). The sensitivity value is the value of the accuracy of the system between the information provided by the system to correctly show negative class data or positive class, while the specificity value is a value that indicates the level of success to find out correctly information about data that is negative class or positive class for accuracy values. used to see the level of closeness between the predicted value of the system and the predicted value of humans in the test (22). Random Forest displays the results of the classification in the Random Forest method capable of predicting the current class of 44 and the jammed 6. The value of accuracy is 96.15%, sensitivity is 95.65% and specificity is 94.1%.

4 CONCLUSIONS

An overview of customer data at Bank BRI Unit Sikur in 2020-2021, namely the highest borrower or debtor carried out by the male gender with a large 66% and for the female gender by 34%. The results of the classification analysis of 3 methods, namely the Naive Bayes method, produce an accuracy value of 92.31%, specificity of 83.33%, sensitivity of 93.48%, K-Nearest Neighbor with k=9 accuracy, 0% specificity, 1% sensitivity and Random Forest, namely Accuracy 96.15%. %, 1% specificity and 95.65% sensitivity. so that the best method for detecting credit disbursement at the BRI Sikur Unit, Sikur sub-district, East Lombok, from 3 classification methods, namely the Random Forest method with an accuracy value of 96.15%.

REFERENCES

- [1] Ginting Rebekah D B. (2018). The process of granting the empress credit at PT Bank Sumut Simpang Kwala Medan branch office.
- [2] Hasibuan. (2007). Effect of Car, Ldr, and Bank Size on Npl in Banking Institutions Listed on the Indonesia Stock Exchange. Journal of Bhishma Ganesha University of Management Department of Management, 2,3.
- [3] Desmayanti Anisa, and Ratna Widayati. (2020). Settlement of Non-performing Loans at PT. Bank Nagari Pariaman Branch. Academy of Finance and Banking "Development". field. OSF Preprints 2020.
- [4] Fauzi A. (2018). Bad Loans, NPLs And Their Influence On Company Performance In Financing Companies. Jumabis : Journal of Management and Business 2 (1),2018
- [5] Marie IA, Lukmanul Hakim, et al. (2019). Comparison of the performance of engine breakdown classification techniques in the production process of making car batteries. Industrial engineering scientific journal. 18(1), 33-41.
- [6] Shofa Rami A, Lailil M, et al. (2014). Application of the Fuzzy K-Nearest Neighbor (FK-NN) Method to Determine the Quality of Sugarcane Yield Yield. Repotition of PTIIK UB Student Journal 3 (2)
- [7] MF Arifin and D. Fitriannah. (2018). Application of C4.5 Classification Algorithm in Recommendation for Acceptance of Sales Partners Case Study : PT Atria Artha Persada. IncomTech, vol.8, no. 2, pp. 87-102
- [8] Ananda Wahyu, M Safii, and M Fauzan. (2021). Prediction of Total Palm Oil Yield Using the Naive Bayes Algorithm. Tunas Bangsa Stick and Amik Tunas Bangsa Pematangsiantar. North Sumatra. TIN: Applied Archipelago Informatics, Vol 1, No 10, March 2021, Page 513-519

- [9] Eliyen K, Herman Tolled and Muhammad Aziz M.(2017). K-Nearest Neighbor for assessment classification in virtual patient cases. Indonesian Journal of Electrical Current 3 (1), 15-18.
- [10] Admojo Fadhila Tangguh and Ahsanawati. (2020). Classification of Alcohol Aroma Using the KNN Method. Informatics Engineering, STMIK Palcomtech. Palembang and Gadjah Mada University Yogyakarta. Journal Of Data And Science, vol 1(2),34-38.
- [11] Nugroho Y. S, and Nova Emiliyawati. (2017). Variable Classification System of Consumer Acceptance of Cars Using the Random Forest Method. Faculty of Communication and Informatics, University of Muhammadiyah Surakarta. Journal of Electrical Engineering, Vol 9 (1),24-29.
- [12] Liaw A, Wiener M. (2002). Classification And Regression By Random Forest. R News Vol. 2/3:18-22.
- [13] Afifaturahman A D. (2021). Comparison of K-Nearest Neighbor and Naïve Bayes Algorithm Using Parameters of Metric Accuracy, Sensitivity and Specificity in Intrusion Detection System (IDS).
- [14] Annisa R. (2019). Comparative analysis of data mining classification algorithms for prediction of heart disease sufferers. JTIK (Journal of Informatics Engineering Kaputama) 3 (1), 22-28.
- [15] Romli Ikhsan, Ahmad Turmudi. (2020). Determination of Overtime Schedule With Employee Data Classification Using C4.5 Algorithm. Technical Information. Pelita Bangsa University. Journal of computer science and informatics (J-SAKTI) Vol 4 (2) 694-702
- [16] Fiarni C, Herastia Maharani, et al. (2016). Sentiment Analysis System For Indonesia Online Retail Shop Review Using Hierarchy Naïve Bayes Technique. International Conference On Information Andcommunication Technology (Icoict), 1-6
- [17] Anthony S, Fauci, et al. (1997). Harrison's Principles Of Internal Medicine Ed. New York : McGraw-Hill

- [18] MRS Rupali K, MR Sanjay Shitole. (2021). Analysis Of Crop Disease Detection With SVM, KNN And Random Forest Classification. *Information Technology In Industry* 9(1), 364-372.
- [19] Robb, A. and Wolken, J. (2002). Firm Owner And Financing Characteristic: Differences Between Female And Male Small Business, Working Paper
- [20] Coleman, S. (2000). Access To Capital And Term Of Credit: A Comparison Of Man And Women Owned Small Business. *Journal Of Small Business Management*, 38, Pp37-52.
- [21] Afriyeni, and Yosef Eka Putra. (2019). Analysis of Factors Affecting the Rate of Return on People's Business Credit (KUR) PT. BANK Rakyat Indonesia (BRI) Unit Talang Unit Solok. Padang Academy of Finance and Banking. OSF Preprints 2019.
- [22] Azhari Mulkan, Zakaria Situmorang et al. (2021). Comparison of Recall Accuracy and Classification Precision in the C4 Algorithm. 5, Random forest, SVM, and Naive Bayes. St. Thomas Catholic University Medan, Medan. *Journal of Media Informatics Budidarma*, Vol 5, Number 2, April 2021, Page 640-651.

IMPLEMENTATION OF EXPONENTIAL SMOOTHING AND ARIMA ON COLLECTION AND DISTRIBUTION DATA OF ZAKAT, INFAQ AND SHADAQAH 2015-2020

**Sopiana Indra Wardani¹, Wiwit Pura Nurmayanti²,
Siti Arni Wulandya³, Muhammad Gazali⁴**

^{1,2,3,4}Hamzanwadi University (INDONESIA)

sopianawardani@gmail.com

Abstract

Time series analysis is an analysis used to predict the future, where ARIMA and Exponential Smoothing (ES) are part of time series analysis. Both methods can be used to predict an event. ARIMA is used for all types of data patterns, while ES is used for data with random patterns. BAZNAS has data related to the collection and distribution of zakat, infaq and shadaqah. Where the data has a high difference between collection and distribution, especially in 2016. One of the contributing factors is the construction of a hospital in Labuhan Haji District, East Lombok. Based on this, it is important for BAZNAS to anticipate future problems such as increasing demand for incoming funds. Therefore, forecasting is carried out to find out further data, whose forecasting results can be a reference for determining the right strategy in minimizing further problems using the ARIMA and ES methods. This study aims to determine the best model and forecasting results in 2021 and 2022 from the data on the amount of collection and distribution of zakat, infaq and shadaqah. The results of the analysis show that the best model of collection is a model with parameters alpha 0.17, beta 0.038, and gamma 0.095 from the Triple ES with forecasting results of Rp.857,903,334 – Rp.1,326,395,361 with MAPE of 15.26. As for the distribution data with alpha 0.039, beta 0.43, and gamma 0.55 from the Triple ES, the forecasting results are Rp.895,754,958 - Rp.2,314,261,380 with MAPE 203.33.

Keywords: Time Series, ARIMA, Exponential Smoothing, BAZNAS East Lombok.

1 INTRODUCTION

Time series is defined as a collection of observations made based on a time index in a row or sequentially over time with fixed time intervals [17][22]. Time series forecasting models use mathematical techniques based on historical data to forecast [6]. Exponential smoothing and ARIMA are part of time series analysis, where both of these methods aim to forecast future data using past data. Forecasting time series data is an important subject in economics, business, and finance as an estimate of the amount of data in the future by utilizing past data based on a mathematical equation [12][16].

The exponential smoothing method is a smoothing/improvement procedure for time series data that is carried out continuously in forecasting the latest observation objects [3][9]. The exponential smoothing method is more appropriate to use to predict things that fluctuate randomly or irregularly [5]. The exponential smoothing method is divided into three, namely single exponential smoothing, double exponential smoothing and triple exponential smoothing.

The single exponential smoothing method assumes that the data fluctuates around a fixed mean value without a trend or consistent growth pattern [18]. SES is useful for forecasting trendless and non-seasonal series and non-stationary series using one predicted past value and one true past value to obtain a smoothing curve [2][10]. Double exponential smoothing is used when data shows an exponential smoothing trend, with a trend like simple smoothing except that two components must be updated every period – the level and the trend, the level is a smoothed approximation of the data value at the end of each period [13][18][21]. While the triple exponential smoothing method is a development of the simple exponential smoothing method that uses three smoothing constants, namely the stationary element, trend smoothing, and seasonal smoothing using three weightings in its prediction, namely α , β and γ [4] [7][14]. Then, ARIMA is a classical forecasting model that produces forecasts based on the synthesis of historical data patterns determined by three

parameters (p , d , q) each showing the autoregressive window size, difference order, and moving average [1][11][15].

The exponential smoothing and ARIMA methods are applied to time series data including data contained in the BAZNAS institution. The BAZNAS institution has data on the collection and distribution of zakat, infaq and shadaqah. Zakat, infaq and shadaqah are part of generosity in the context of the Muslim community which plays a strategic role in encouraging the even distribution of the prosperity of the people of a country [8].

Collection and distribution data of zakat, infaq and shadaqah at BAZNAS is influenced by economic factors, health, and community conditions which cause the amount of collection and distribution to be inconsistent and not constant every month and year. In addition, there is a very high discrepancy between collection and distribution data of ZIS, especially in 2016. One of the factors that caused it was the construction of a hospital in Labuhan Haji District, East Lombok. Based on this, to find out the amount of subsequent collection and distribution as a reference for BAZNAS institutions to anticipate problems that will occur, the researchers do forecasting by applying time series analysis with exponential smoothing and ARIMA methods.

Rafikasi and Ahmad [19] who conducted research on the prediction of the potential for zakat mal/profession using the forecasting method with ARIMA and exponential smoothing which were compared to obtain the best method in forecasting the amount of zakat receipts from Mal/Profession in Tulungagung Regency for the next period. The best model obtained is the model from the SES method, the model from ARIMA is not used because the ARIMA model does not meet white noise. However, Rafikasi and research did not use the TES method and did not display the parameters of the best model and the forecast error value, while in this study using the TES method, it displayed the model parameters and the forecast error value. In addition, the research conducted by Rafikasi and Ahmad did not use the assumption of normality and homogeneity in the ARIMA

method, while in this study, apart from using the white noise assumption, the two assumptions were also tested.

In addition, Setiyawan et al [20] also conducted research using the exponential smoothing method, namely double exponential smoothing about application development and forecasting infaq sadaqah. Setiyawan et al research only uses the DES method but in this study uses a comparison between ARIMA, SES, DES and TES. In addition, the research conducted by Setiyawan et al aims to design an information system that makes it easier for donors to get their reports to the beneficiaries quickly and accurately. Meanwhile, this study aims to obtain the best model and obtain forecasting results using the best model.

Therefore, to predict the collection and distribution of zakat, infaq, and shadaqah, the researchers conducted forecasting by applying time series analysis with the single exponential smoothing, double exponential smoothing, triple exponential smoothing and ARIMA methods using data from BAZNAS related to the collection and distribution of zakat, infaq and shadaqah 2015-2020 with the title "Implementation of Exponential Smoothing and ARIMA on Collection and Distribution Data of Zakat, Infaq and Shadaqah 2015-2020".

2 METHODOLOGY

The type of research used in this study is quantitative research with secondary data in the form of numbers, namely data on the number of collection and distribution of zakat, infaq and shadaqah in rupiah units. The data used in the form of time series data in 2015 – 2020 obtained directly from the National Amil Zakat Agency (BAZNAS) East Lombok Regency, NTB. This research was conducted from February to April 2021 at the National Amil Zakat Agency (BAZNAS), Selong, Selong District, East Lombok Regency. The variables used in this study are collection and distribution data of zakat infaq and shadaqah which are analyzed using time series analysis using exponential smoothing and ARIMA methods.

3 RESULTS

3.1 Descriptive Analysis

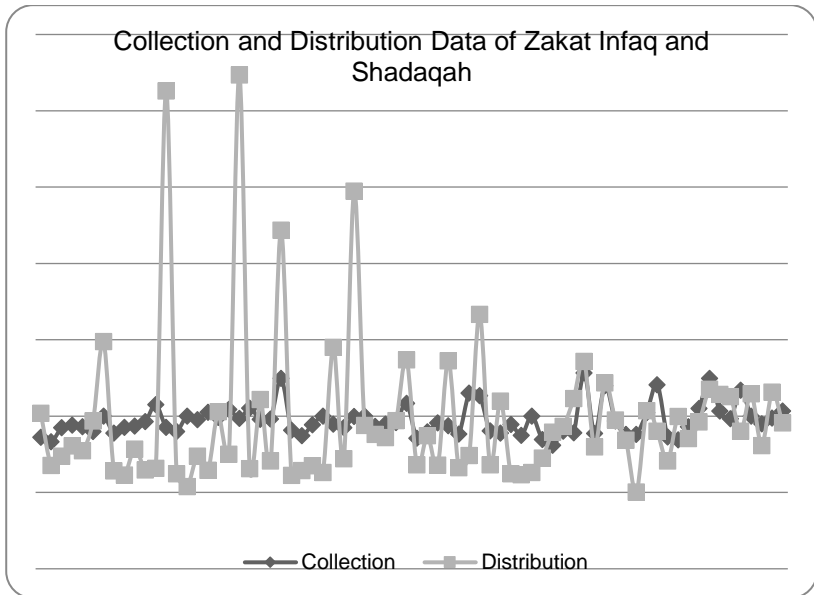

Figure 1. Line diagram collection and distribution data of ZIS

Figure 1 shows that the lowest amount of zakat infaq and shadaqah collection occurred in February 2019 of Rp. 618,800,000 and the highest in May 2019 of Rp. 1,563,000,000. Meanwhile, the lowest distribution of zakat, infaq and shadaqah occurred in October 2019 of Rp. Rp.4,384,000 and the highest was in August 2016 of Rp.5,471,000,000.

3.2 Time Series Test

Time series analysis is carried out using two methods, namely the ARIMA method and exponential smoothing, where the exponential smoothing method is divided into three methods, namely single

exponential smoothing, double exponential smoothing and triple exponential smoothing.

By using the ARIMA method, the collection and distribution data are not stationary in terms of variance and mean. Therefore, transformation and differencing of data is carried out. After doing the transformation and differencing once, the data collection and distribution are also stationary in variance and mean.

3.1.1 Collection Data

The following table 1 presents the model formed using the ARIMA method. The best model obtained is the ARIMA model (1, 1, 1) with the third smallest AIC value of 2916.82. The ARIMA (1, 1, 1) model was chosen because the two models that have an AIC value smaller than ARIMA (1, 1, 1) do not meet the assumption test of normality, homogeneity and autocorrelation while ARIMA (1, 1, 1) meet the assumption test but only normality test. So the ARIMA (3, 1, 1) model is not suitable for predicting further data.

Table 1. The model formed on the collection data using the ARIMA method

MODEL	AIC
IMA (0, 1, 1)	2928.67
ARI (1, 1, 0)	2963.7
ARI (2, 1, 0)	2949.5
ARI (3, 1, 0)	2941.17
ARIMA (1, 1, 1)	2916.82
ARIMA (2, 1, 1)	2911.77
ARIMA (3, 1, 1)	2907.91

After analyzing using the exponential smoothing method, the results of the ARIMA and exponential smoothing methods can be compared in Table 2 below.

*Table 2. Comparison of the value of Error measures
of collection data*

Method	Alpha	Beta	Gamma	MAPE
SES	0.12			15.85
DES	0.22	0.19		18.69
TES	0.17	0.04	0.09	15.25
ARIMA (1, 1, 1)				17.18

Based on Table 2, it can be seen that the best model of the four methods is the model from the method that has the smallest MAPE value, namely the model with alpha parameters = 0.17; beta = 0.04 and gamma = 0.09 from the triple exponential smoothing method which has the smallest MAPE value of 15.25.

Therefore, the best model chosen to predict the collection of zakat, infaq and shadaqah data is the triple exponential smoothing method. So that the forecasting results can be obtained using the model of the triple exponential smoothing method of Rp.857,903,334 to Rp.1,326,395,361. The following presents the differences from the original data and the results of forecasting the amount of zakat, infaq and shadaqah collection in the form of a line diagram in Figure 2. The data pattern from the forecasting results seems to follow the actual data where the forecasting data tends to trend and has a random pattern but looks more constant.

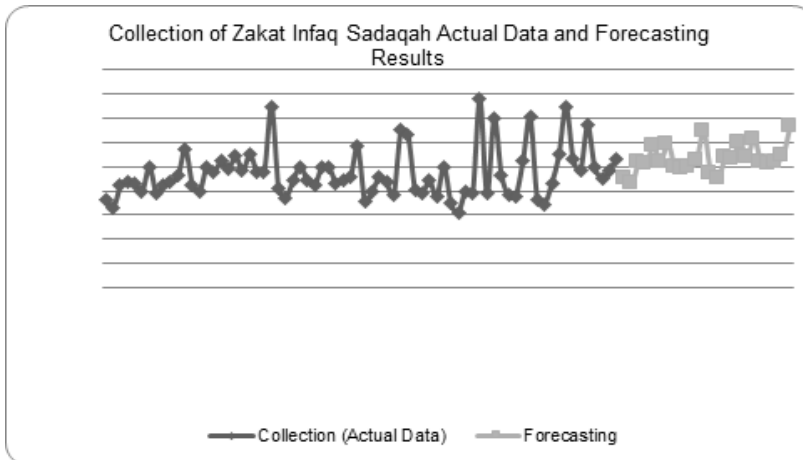

Figure 2. Line chart for collection data and forecasting results

3.1.2 Distribution Data

Next in Table 3 is the modeling for the distribution of zakat, infaq and shadaqah data. The best model obtained is the ARIMA (3, 1, 1) model with the smallest AIC value of 3136.65. After testing the assumptions, the ARIMA (3, 1, 1) model does not meet the assumptions of normality, homogeneity and autocorrelation tests. So the ARIMA (3, 1, 1) model is not suitable for predicting further data.

Table 3. The model formed on the distribution data using the ARIMA method

MODEL	AIC
IMA (0, 1, 1)	3171.03
ARI (1, 1, 0)	3193.5
ARI (2, 1, 0)	3179.68
ARI (3, 1, 0)	3167.59
ARIMA (1, 1, 1)	3144.36
ARIMA (2, 1, 1)	3141.19
ARIMA (3, 1, 1)	3136.65

After analyzing using the exponential smoothing method, the results of the ARIMA and exponential smoothing methods can be compared in Table 4 below.

Table 4. Comparison of Error measures of distribution data

Method	Alpha	Beta	Gamma	MAPE
SES	6.6107e-05			454.88
DES	0.22	0.36		553.32
TES	0.04	0.43	0.55	203.33
ARIMA (3, 1, 1)				516.97

Based on Table 4, it can be seen that the best model of the four methods is the model from the method that has the smallest MAPE value, namely the model with alpha parameters = 0.04; beta = 0.43 and gamma = 0.55 from the triple exponential smoothing method which has the smallest MAPE value of 203.33.

Therefore, the best model chosen to predict the distribution of zakat, infaq and shadaqah data is the triple exponential smoothing method. So that the forecasting results can be obtained using the model of the triple exponential smoothing method of Rp.895,754,958 to Rp.2,314,261,380. The following presents the differences from the actual data and the results of forecasting the distribution of zakat, infaq and shadaqah in the form of a line diagram in Figure 3. The data pattern from the forecasting results seems to follow the actual data which has a random pattern but looks more constant and tends to trend up.

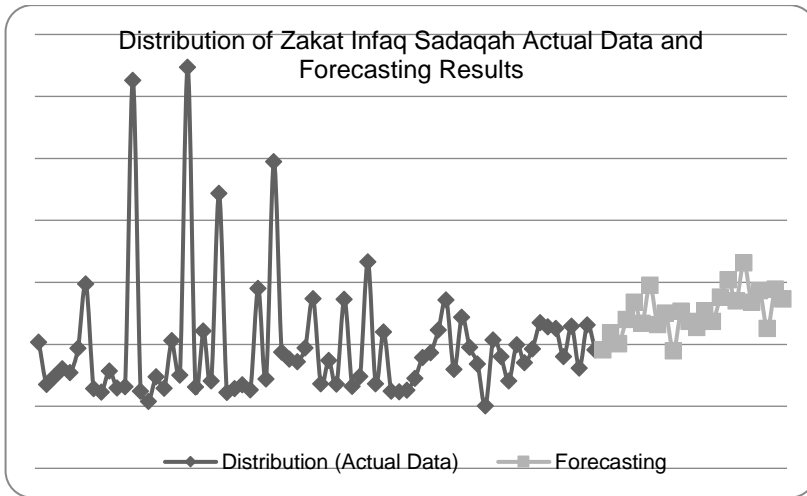

Figure 3. Line diagram for distribution amount data and forecasting data

4 CONCLUSIONS

The best model for the collection of zakat, infaq and shadaqah data is the triple exponential smoothing method using R software with parameters alpha (α) = 0.17, beta (β) = 0.04, and gamma (γ) = 0.09. So that forecasting can be done using the triple exponential smoothing method because it has the smallest MAPE value of 15.26.

The best model for forecasting the distribution of zakat, infaq and shadaqah data is the triple exponential smoothing method using R software with parameters alpha (α) = 0.04, beta (β) = 0.43, gamma (γ) = 0.55. So that forecasting can be done using the triple exponential smoothing method because it has the smallest MAPE value of 203.33.

The results of forecasting using the triple exponential smoothing method for collecting zakat infaq and shadaqah data in 2021 and 2022 are Rp. 857,903,334 to Rp. 1,326,395,361.

The results of forecasting using the triple exponential smoothing method for the distribution of zakat infaq and shadaqah data in 2021 and 2022 range from Rp.895,754,958 to Rp.2,314,261,380.

REFERENCES

- [1] Alghamdi T et al. 2019. *Forecasting Traffic Congestion Using ARIMA Modeling*. 978-1-5386-7747-6/19/\$31.00 ©2019 IEEE.
- [2] Chusyairi A et al. 2018. *Optimization of Exponential Smoothing Method Using Genetic Algorithm to Predict E-Report Service*. 2018 3rd International Conference on Information Technology, Information Systems and Electrical Engineering (ICITISEE), Yogyakarta, Indonesia ISBN: 978-602-60280-0-6.
- [3] Dev S et al. 2018. *Solar Irradiance Forecasting Using Triple Exponential Smoothing*. 978-1-5386-5326-5/18/\$31.00 © 2018 IEEE.
- [4] Dhamodharavadhani S and R. Rathipriya. 2019. *Region-Wise Rainfall Prediction Using MapReduce-Based Exponential Smoothing Techniques*. India; Periyar University.
- [5] Falani I. 2018. *Penentuan Nilai Parameter Metode Exponential Smoothing Dengan Algoritma Genetik dalam Meningkatkan Akurasi Forecasting*. CESS (Journal Of Computer Engineering System And Science) Vol. 3 No. 1 Januari 2018 p-ISSN :2502-7131 e-ISSN :2502-714x.
- [6] Fattah J et al. 2018. *Forecasting of Demand Using ARIMA Model*. International Journal of Engineering Business Management Volume 10: 1–9^a The Author(s) 2018 DOI: 10.1177/1847979018808673 journals.sagepub.com/home/enb.
- [7] Fitria V dan Samsul A. 2020. *Penerapan Triple Exponential Smoothing dalam Meramalkan Laju Inflasi Bulanan Provinsi Aceh Tahun 2019 – 2020*. E-Jurnal Ekonomi dan Bisnis Universitas Udayana 9.1 (2020):23-38 ISSN: 2337-3067.
- [8] Habib AA. 2016. *The Principle of Zakat, Infaq, And Shadaqah Accounting Based SFAS 109*. Journal of Accounting and Business Education, 1 (1), September 2016.
- [9] Hasanah F. 2019. *Penerapan Metode Exponential Smoothing dalam Memprediksi Jumlah Peserta Didik Baru di MAN 2 Kota Jambi*. Fakultas Tarbiyah dan Keguruan Universitas Islam Negeri Sulthan Thaha Saifuddin: Jambi.

- [10] James F. 2021. *Neural Network-Based Time Series Forecasting of student Enrollment with Exponential Smoothing Baseline and Statistical Analysis of Performance*. Kansas: Kansas State University.
- [11] Kufel T. 2020. *ARIMA-Based Forecasting of the Dynamics of Confirmed Covid-19 Cases for Selected European Countries*. *Equilibrium*. Quarterly Journal of Economics and Economic Policy, 15(2), 181–204. doi: 10.24136/eq.2020.00 Volume 15 Issue 2 June 2020 p-ISSN 1689-765X, e-ISSN 2353-3293.
- [12] Namin SS and Akbar SN. 2018. *Forecasting Economic and Financial Time Series: ARIMA vs. LSTM*. USA: Texas Tech University.
- [13] Nazim A and Asyraf A. 2014. *A Comparison Between Single Exponential Smoothing (SES), Double Exponential Smoothing (DES), Holt's (Brown) and Adaptive Response Rate Exponential Smoothing (ARRES) Techniques In Forecasting Malaysia Population*. *Global Journal of Mathematical Analysis*, 2 (4) (2014) 276-280.
- [14] Niu T et al. 2020. *An Improved Prediction Model Combining Inverse Exponential Smoothing and Markov Chain*. *Hindawi Mathematical Problems in Engineering* Volume 2020, Article ID 6210616, 11 pages <https://doi.org/10.1155/2020/6210616>.
- [15] Nurjanah IS dkk. 2018. *Implementasi Model Autoregressive Integrated Moving Average (Arima) Untuk Peramalan Jumlah Penumpang Kereta Api di Pulau Sumatera*. *Jurnal Teorema: Teori dan Riset Matematika* Vol 3 No 2, Hal 145-156, September 2018 p-ISSN 2541-0660, e-ISSN 2597-7237 © 2018.
- [16] Pamungkas MB dan Arief W. 2018. *Aplikasi Metode ARIMA Box-Jenkins untuk Meramalkan Kasus DBD di Provinsi Jawa Timur*. *The Indonesian Journal of Public Health*, Vol 13, No 2 Desember 2018: 181-194.

- [17] Pujiati E dkk. 2016. *Peramalan Dengan Menggunakan Metode Double Exponential Smoothing Dari Brown (Studi Kasus: Indeks Harga Konsumen (IHK) Kota Samarinda)*. Jurnal EKSPONENSIAL Volume 7, Nomor 1, Mei 2016 ISSN 2085-7829.
- [18] Purba A. 2015. *Perancangan Aplikasi Peramalan Jumlah Calon Mahasiswa Baru yang Mendaftar Menggunakan Metode Single Exponential Smoothing*. Jurnal Riset Komputer (JURIKOM), Vol. 2 No. 6, Desember 2015 ISSN 2407-389X (Media Cetak).
- [19] Rafikasi EF dan Ahmad S. 2018. *Prediksi Potensi Zakat Mal/Profesi Menggunakan Exponential Smoothing*. Jurnal Iqtisaduna Volume 4 Nomor 2 Ed. Desember 2018 : page 254-270 p-ISSN: 2460-805X e-ISSN : 2550-0295 DOI : 10.24252/iqtisaduna.v4i2.6563.
- [20] Setiyawan E dkk. 2020. *Pengembangan Aplikasi dan Peramalan Infaq Sadaqah Menggunakan Metode Double Exponential Smoothing*. Seminar Informatika Aplikatif Polinema (Siap) 2020 ISSN 2460-1160.
- [21] Silitonga PDP et al. 2020. *Forecasting Acceptance of New Students Using Double Exponential Smoothing Method*. Journal of Critical Reviews ISSN- 2394-5125 Vol 7, Issue 1, 2020.
- [22] Sumarjaya IW. 2016. *Modul Analisis Deret Waktu*. Bukit Jimbaran: Universitas Udayana.

ANALYSIS OF DIAGNOSIS CLASSIFICATION OF DENGUE HEMORRHAGIC FEVER (DHF) USING RANDOM FOREST AND BAGGING METHOD WITH IMBALANCED CLASS RESAMPLING TECHNIQUE

Nurhidayah¹, Muhammad Gazali², Siti Arni Wulandya³

^{1,2,3}HamzanwadiUniversity (INDONESIA)

ndayah716@gmail.com

Abstract

In Indonesia there are various types of infectious diseases including Dengue Hemorrhagic Fever (DHF). Dengue Hemorrhagic Fever (DHF) is a disease caused by the bite of the *Aedes Aegypti* mosquito which causes dengue virus infection and can cause clinical symptoms, such as high fever for 2-7 days in a row. DHF can cause death if not handled properly, so it is important to do an early examination by conducting a hematological test to diagnose a positive or negative patient with DHF. Based on the patient's examination data, classification analysis can be carried out using the Random Forest and Bagging method. Both of these methods have the advantage of reducing the error rate in the classification results, being strong against high data imbalances, and being able to handle large datasets. However, because the data used has an unbalanced number of classes, a resampling technique approach (Under Sampling, Over Sampling, SMOTE) will be used by resampling the original data to overcome unbalanced data and to get good classification results. The data used is data on diagnosing dengue fever for patients at the Mataram City Hospital in 2020. Based on the results of the study, it was found that the more appropriate method for classifying data on diagnosing dengue disease was the Over Random Forest method, because the accuracy value of this method was higher than the others, which was 98.19 %. The difference in accuracy between Over Random Forest and Over Bagging methods is 0.78%.

Keywords: Dengue Hemorrhagic Fever (DHF), Classification, Random Forest, Bagging

1 INTRODUCTION

Indonesia as a tropical country that makes diseases easy to develop, one of which is dengue fever which is still a public health problem in Indonesia. Dengue Hemorrhagic Fever (DHF) is an infectious disease caused by the dengue virus which is transmitted through the *Aedes Aegypti* mosquito, this disease can cause clinical manifestations such as bleeding that can cause shock so that in death, dengue transmission is most common during the rainy season in the tropics and tropical areas. sub-tropical [18][8][1]. The incidence of dengue cases tends to increase every year in various provinces in Indonesia, especially the province of West Nusa Tenggara (NTB). In 2019 in the province of NTB, Mataram City ranked first in the incidence of dengue cases out of 10 districts/cities with 956 cases triggered by the increase in population density in the city of Mataram [5][9][20]. The Mataram City Hospital in 2020 handled 819 positive dengue fever patients, causing 1 of them to die. Early examination is very important to prevent death due to DHF cases by conducting hematological tests, namely blood checks in the laboratory by looking at hemoglobin levels, hematocrit levels, platelet levels, leukocyte levels based on gender and age of the patient to detect positive or negative DHF by doctors. So from the results of the patient's examination data can be classified into a positive class of DHF or a negative class of DHF based on the characteristics possessed by the patient.

Classification analysis is a process to build a model in classifying data based on predetermined groups and classes [22][21]. In this case, there are many classification algorithms that can be used to classify data, including random forest and bagging methods.

Random Forest is a method developed from the CART (Classification and Regression Trees) method and this method is included in the method, which is also a method or algorithm of decision tree techniques [12][2]. What distinguishes the random forest method from the CART method is that the Random Forest applies the bootstrap aggregating (bagging) method and also random feature selection or can be called random feature selection [3]. can handle

large numbers of datasets, is effective in dealing with missing data, and can produce a high level of accuracy. Meanwhile, the drawback of the random forest method is the long modeling time (depending on the number of decision trees produced) [13][14]. Meanwhile, bagging is an ensemble method that uses bootstrap techniques to generate new data clusters to make classifiers in many terms [17]. When compared with a single classifier, the results of the bagging classifier are more accurate [25]. The bagging method also has advantages in handling data with high data imbalance and is able to improve classification accuracy well [10].

The difference between the random forest and bagging methods lies in the sub-setting stage, where the random forest method produces different trees, while the bagging method produces relatively the same trees [16].

A data sometimes has an unbalanced class problem that makes the classification results inaccurate, so to get the right classification results a resampling technique approach can be used as a solution in overcoming the unbalanced class problem [4][15]. Resampling technique is a preprocessing which balances the distribution of data back to reduce the effect of unbalanced class distributions in the training data process by balancing the original data based on a series of sampling algorithm methods to adjust the number of samples of different classes and then training the new balanced data by adopting a classification algorithm [15]. There are several resampling techniques that can be used such as undersampling, oversampling, and SMOTE (Synthetic Minority Over-sampling Technique). Undersampling is a data balancing technique by reducing the data in the majority class, but the weakness of this method is that it can cause data loss which is considered important by machine learning in making decisions. While oversampling is a data balancing technique by adding data to the minority class, the oversampling technique is more likely to occur due to overfitting due to excessive duplicating of data in the minority class. So, to overcome the overfitting problem, the SMOTE technique can be used which is an approach to oversampling.

SMOTE is an oversampling method that works by making synthetic data or artificial data generated based on the characteristics of the nearest object and k-neighbor (k-nearest neighbour) [11][9][4][23].

There are several previous researchers who used random forest and bagging methods. Among them, by Wulandari et al [24], who conducted research on the classification of household welfare levels in West Kalimantan using the bagging classification trees method to determine the accuracy of the classification results, which in his research resulted that the bagging classification trees method could improve the classification results compared to without using bagging. In the research of Wulan et al, in determining the accuracy of the classification results, they only used the APER (Apparent error rate) value and did not use software assistance. Meanwhile, in this study, the best model was evaluated first and to determine the accuracy of the classification results, the values of accuracy, sensitivity, and specificity were used and the calculations used the help of R Studio software. Based on the explanation above, to determine the accuracy of the classification results on the data on diagnosing dengue fever for patients at the Mataram City Hospital in 2020 with imbalanced data problems, random forest and bagging methods will be used by looking at the accuracy, sensitivity, and specificity values generated. Therefore, in this study the title "Analysis of the Diagnosis of Dengue Hemorrhagic Fever (DHF) using Random Forest and Bagging Methods with Imbalanced Class Resampling Techniques".

2 METHODOLOGY

The type of research used in this research is quantitative research, with the type of data, namely secondary data sourced from data on the diagnosis of dengue disease and the results of patient examinations in the laboratory regarding the diagnosis of dengue disease in 2020. This research was carried out at the Mataram City Hospital on February 23 s/ d March 24, 2021. The variables used are Gender (X₁), Age (X₂), Hemoglobin (X₃), Hematocrit (X₄), Platelets (X₅), Leukocytes (X₆), Positive DHF (Y₁), and Negative

DHF (Y₂). The method used in this research is the Random Forest and Bagging (Bootstrap Aggregating) method as well as the resampling technique. The software used in the data analysis process is Microsoft Excel 2010 and R Studio.

The stages of analysis in this study are as follows:

1. Inputting data on the diagnosis of dengue fever for patients at the Mataram City Hospital 2020.
2. Conduct descriptive analysis to find out the description of the research data.
3. Divide training data (training data) by 75% and testing data (test data) by 25% to perform classification analysis.
4. Determine m number of predictor variables and k trees to be formed to obtain good classification results using random forest and bagging methods. The value of m = 1, 3, 5 and the value of k = 25, 50, 100, 250, 300, 500.
5. Form a classification model from each number of predictor variables (m) that has been formed with a default value of ntree (k) which is 500 and form a classification model from each ntree (k) that has been determined with the best m value using random forest and bagging methods.
6. Taking samples with a sampling technique with returns so that a new data set is obtained.
7. Forming a tree model from a new database with a combination of m predictor variables and k tree sizes using predetermined training data.
8. Make predictions on the formed model using predetermined testing data (test data).
9. Comparing the classification accuracy of the random forest and bagging methods, as well as by using resampling techniques.
10. Make a plot of the variable importance of the best method that can classify research data appropriately.

3 RESULTS

a. Descriptive Analysis

3.1.1 Percentage of Patients based on Diagnosis of DHF

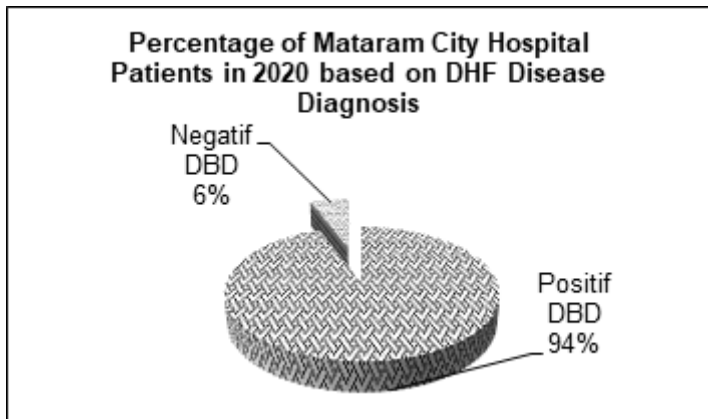

Figure 1. Percentage of Patients based on Diagnosis of DHF

Figure 1 shows that throughout 2020 the Mataram City Hospital has treated patients with a positive diagnosis of DHF as many as 94% or 819 patients while patients with a negative diagnosis of DHF were 6% or 49 patients. Based on data from the West Nusa Tenggara (NTB) Provincial Health Office in 2021, in 2020 DHF cases reached 3,919 cases spread across 10 regencies/cities throughout NTB and Mataram City were included as the largest contributor to DHF cases in NTB Province. population density of Mataram City which can facilitate the spread of dengue virus by the *Aedes Aegypti* mosquito [6].

3.1.2 Percentage of DHF Positive Patients by Gender

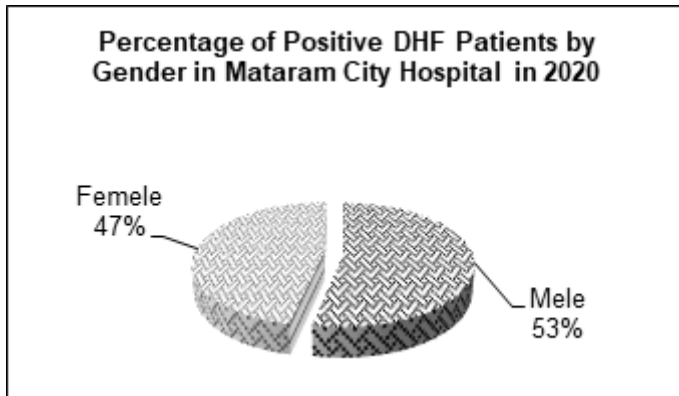

Figure 2. Percentage of DHF Positive Patients by Gender

Figure 2 shows that, throughout 2020, patients diagnosed as positive for DHF were dominated by patients with male sex as many as 436 patients with a percentage of 53% while patients with female sex were 383 patients with a percentage of 47%. This is due to the activity of men who are more active during the day which is the time of exposure to dengue virus vectors and according to data from the West Nusa Tenggara (NTB) Provincial Health Office in 2021, the male sex is more exposed to the dengue virus than the female sex. [19][6].

3.1.3 Percentage of DHF Positive Patients by Age Group

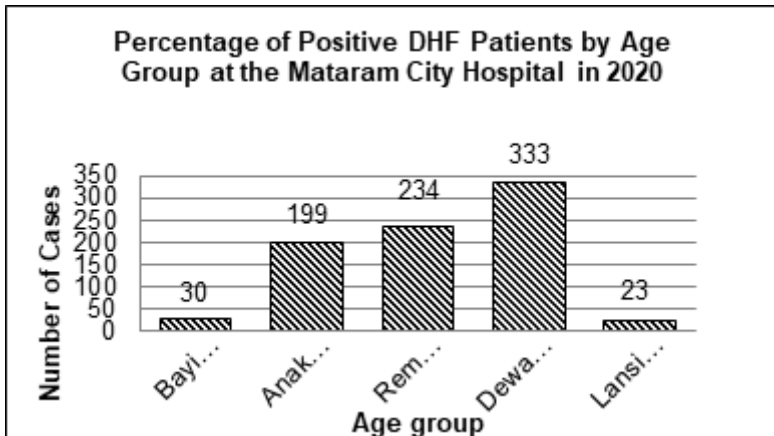

Figure 3. Percentage of DHF Positive Patients by Age Group

Figure 3 explains that, throughout 2020 at the Mataram City Hospital, there were many patients with positive DHF from various age groups ranging from Babies, Children, Teens, Adults, and the Elderly. Where, the Adult age group has the most dominating number of cases, which is 333 cases, and the lowest case is found in the Elderly age group as many as 23 cases, then the age group with the next highest case is Teenagers with 234 cases, Children as many as 199 cases. , and Infants as many as 30 cases. The factors that cause the adult age group to be susceptible to dengue virus because they do not have sufficient immunity to dengue infection with different strotypes and this age group is a productive age group that has more activities during the day both indoors and outdoors. outdoors, and interaction with other people is also high, making it easier for the Aedes Aegypti mosquito to transmit the dengue virus [19].

b. Classification Analysis

3.2.1 Data Training and Data Testing

Training using machine learning algorithms requires training data and test data. Training data is used to create models in machine learning, while testing data is used to predict models in machine learning. In this study, the researcher uses 75% of the data to be tested as training data and uses 25% of the data to be tested as test data.

3.2.2 Determination of the Best Mtry and Ntree

In this study, to obtain an optimal model and a small OOB value, the mtry value (explanatory variable) and the ntree value (number of trees) will first be determined. Here are three ways to determine the mtry value:

$$a. \quad Mtry = \frac{\sqrt{\text{total variable}}}{2} = \frac{\sqrt{7}}{2} = 1.3 \approx 1 \quad (1)$$

$$b. \quad Mtry = \sqrt{\text{total variable}} = \sqrt{7} = 2.6 \approx 3 \quad (2)$$

$$c. \quad Mtry = \sqrt{\text{total variable}} \times 2 = \sqrt{7} \times 2 = 5.2 \approx 5 \quad (3)$$

The mtry value that has been obtained will be classified using the default of the number of ntree trees, which is 500. The results of the OOB error are shown in table 1 below.

Table 1. Testing OOB Error Values with Different Mtry

Method			
Random Forest		Bagging	
Mtry	Error OOB	Mtry	Error OOB
1	2.92%	1	2.92%
3	2.46%	3	2.76%
5	3.07%	5	3.07%

In Table 1 it can be seen that from the random forest method the lowest OOB error value is 2.46% with an mtry value of 3 and from the bagging method the lowest OOB error value is 2.76% with an mtry value of 3.

The mtry value with the smallest error in table 1 above will be used to determine the number of trees (ntree). In this study, the number of trees (ntrees) that will be tested are 25, 50, 100, 250, 300, and 500. The following is the error value of each ntree with an mtry value of 3 in the random forest method and the bagging method.

Table 2. Testing OOB Error Values with Different Ntree

Method			
RandomForest		Bagging	
Ntree	Error OOB	Ntree	Error OOB
25	3.53%	25	2.92%
50	2.76%	50	2.76%
100	2.46%	100	3.07%
250	2.61%	250	3.07%
300	2.61%	300	2.92%
500	2.61%	500	2.92%

In Table 2 it can be seen that from the random forest method, the smallest error value is obtained at the 100th ntree with an error value of 2.46%, while in the bagging method the smallest error value is obtained at the 50th ntree with an error value of 2.76%.

3.2.3 Comparison of Classification Models

The following is the error value generated from the optimal mtry and ntree values from the random forest and bagging method in table 3 below:

Table 3. Testing the OOB Error Value with the Best Mtry and Ntree

Method							
Random Forest				Bagging			
Method	Mtry	Ntree	OOB	Metode	Mtry	Ntree	OOB
Random Forest	3	100	2.3%	Bagging	3	50	3.53%
Under	3	100	10.96%	Under	3	50	15.07%
Over	3	100	1.71%	Over	3	50	1.87%
SMOT	3	100	4.08%	SMOTE	3	50	5.08%

Table 3 shows that, in this study, the most optimal model or the one that produces the smallest OOB error value to get good classification results is generated from the over random forest method, using Mtry 3 and Ntree 100 can produce the smallest OOB error value of 1.71%.

3.2.4 Comparison of Classification accuracy

The following are the classification results from the random forest and bagging methods before and after resampling by looking at the results of the Sensitivity, Specificity, and Accuracy values.

Table 4. Comparison of Model Classification Accuracy with Random Forest and Bagging Methods

Method	Sensitivity	Specificity	Akurasi
Random Forest	16.129%	97.867%	91.63%
Under Random Forest	75.00%	78.26%	76.74%
Over Random Forest	96.37%	100%	98.19%
SMOTE Random Forest	95.35%	85.15%	90.31%
Bagging	22.581%	97.600%	91.87%
Under Bagging	75.00%	69.57%	72.09%

Method	Sensitivity	Specificity	Akurasi
Over Bagging	94.82%	100%	97.41%
SMOTE Bagging	95.61%	87.00%	91.36%

Table 4 shows the results of the classification of the random forest and bagging methods before and after resampling, where the classification results of all the methods used in table 4 above the random forest method with over sampling technique can produce a higher sensitivity value of 96.37%, while seen from the resulting specificity value, the over random forest and over bagging methods both have a high specificity level of 100%. Furthermore, it is seen from the level of accuracy which is the percentage of the amount of data that is correctly predicted to the total amount of data. Where it can be seen in table 4 above that the highest level of accuracy is produced by the over random forest method of 98.19%. Therefore, in this study, the best method for classifying data on diagnosing dengue fever in Mataram City Hospital patients with unbalanced data is the over random forest method.

4 CONCLUSIONS

Data on the diagnosis of dengue fever in Mataram City Hospital in 2020 amounted to 868 patients. Where, data on patients diagnosed as positive for DHF were 819 patients, while patients diagnosed with negative DHF were 49 patients. Based on the sex of the positive patients with DHF, there were 436 male patients and 383 female patients. Meanwhile, based on the age group of DHF positive patients, Adults were 333 patients, Teenagers were 234 patients, Children were 199 patients, Infants were 30 patients, and Elderly were 23 patients.

The most optimal classification model is when using the over random forest method using 3 mtry and 100 ntrees with an OOB value of 1.71%. The most appropriate method for classifying data on DHF diagnosis is the Over Random Forest method, because the accuracy value of this method is higher than the others, which is 98.19%. The difference in accuracy between Over Random Forest and Over Bagging methods is 0.78%.

REFERENCES

- [1] Balasaravanan, K. & M. P. (2018). Detection of Dengue Disease Using Artificial Neural Network Based Classification Technique. *International Journal of Engineering & Technology*, 7 (1.3)
- [2] Bharathidasan, S. & C. Jothi Venkataeswaran. Improving Classification Accuracy based on Random. Forest Model with Uncorrelated High Performing Trees. *International Journal of Computer Applications* (0975 – 8887). Vol. 101, No.13
- [3] Binarwati, L. Mukhlash, I. & S. (2017). Implementasi Algoritma Genetika untuk Optimalisasi Random Forest Dalam Proses Klasifikasi Penerimaan Tenaga Kerja Baru: Studi Kasus PT.XYZ. *JURNAL SAINSDAN SENI ITS*. Vol. 6, No. 2, pp. 78-82
- [4] Chawla, N. V., Kevin, W. B., Lawrence, O. H., & W. P. K.(2002). SMOTE: Synthetic Minority Over-sampling Technique. *Journal Of Artificial Intelligence Research*, volume 16
- [5] Dinas Kesehatan Provinsi NTB. (2020). Profil Kesehatan Provinsi Nusa Tenggara Barat Tahun 2019. Mataram: Dinas Kesehatan Provinsi NTB. Hal 77
- [6] Dinas Kesehatan Provinsi NTB. (2021). Profil Kesehatan Provinsi Nusa Tenggara Barat Tahun 2020. Mataram: Dinas Kesehatan Provinsi NTB
- [7] Farasari, R. Muhammad A. (2018). Model Buku Saku dan Rapor Pemantauan Jentik dalam Meningkatkan Perilaku Pemberantasan Sarang Nyamuk. *Journal of Health Education* 3 (2). ISSN 2527-9252
- [8] Fernanda, J.W.&Otok, B.W. (2012). Boosting neuralnetwork dan boosting cart pada klasifikasi diabetesmilitus tipe II. *Jurnal Matematika*, 2 (2).
- [9] Ganganwar, V. (2012). An Overview of Classification Algorithms for Imbalanced Datasets. *International Journal of Emerging Technology and Advanced Engineering*. Vol. 2, Issue 4. ISSN 2250-2459

- [10] Hakim, L. Sartono, B. & Saefuddin, A. (2017). Baggingbased ensemble classification method on imbalanced datasets. *IJCSN- International Journal of Computer Science and Network*, 6(6).
- [11] Hakim, L., Bagus, S., & Asep, S. (2017). Bagging Based Ensemble Classification Method on Imbalance Datasets. *International Journal of Computer Science and Network*. Vol. 6, Issue 6. ISSN (Online) : 2277-5420
- [12] Hartati, A. Zain, I. and Ulama, B. S. S. (2012). Analisis CART (Classification And Regression). *JURNAL SAINS DAN SENI ITS*, vol. 1, no. 1, pp. 101 -105
- [13] Hong, J. Heeyoul, C. & Woo-sung, K. (2019). A House Price Valuation Based on the Random Forest Approach: The Mass Appraisal of Residential Property in South Korea. *International Journal of Strategic Property Management*. ISSN: 1648-715X / eISSN: 1648-9179
- [14] Jihad, A. Rehanullah, K. Nasir, A. & Imran, M. (2012) Random Forests and Decision Trees. *International Journal of Computer Science Issues*. Vol. 9, Issue 5, No 3. ISSN (Online): 1694-0814
- [15] Jian, C., Gao, J., & Ao, Y. (2016). A New Sampling Method for Classifying Imbalance Data Based on Supportvector Machine Ensemble. *Neurocomputing*, 193, 115-122
- [16] Marie, I. A., Lukman, H., Dedy, S., & Winnie, S. (2019). Perbandingan Performansi Teknik Klasifikasi Breakdown Mesin pada Proses Produksi Pembuatan Battery Mobil. *JURNAL ILMIAH TEKNIK INDUSTRI*. Vol. 18(1). p-ISSN 1412-6869, e-ISSN 2460-4038
- [17] Meidianingsih, Q. & Debby, A. (2020). Kajian Penerapan Bagging pada Metode Safe-Level SMOTE dalam Penanganan Klasifikasi Tidak Seimbang. *Indonesia Jurnal Of Statistic and it is aplications*. Vol. 5, No. 1, 05-116. e-ISSN: 2599-0802
- [18] Prasetyani, R. D. (2015). Faktor-Faktor yang Berhubungan dengan Kejadian Demam Berdarah Dengue. *Majority*. Vol. 4, No. 2

- [19] Saraswati, L. P. C. & Ni, K. M. (2017). Prevalensi Demam Berdarah Dengue (Dbd) Primer dan Sekunder Berdasarkan Hasil Pemeriksaan Serologis di Rumah Sakit Balimed Denpasar. *JURNAL MEDIKA*. Vol. 6, No 8
- [20] Supardan, D. (2019) Pemetaan Distribusi Vektor Virus Dengue di Kota Mataram Berbasis Geographic Information Systems (GIS). *Jurnal Sains & Pendidikan Biologi*. Vol. 2, No. 2
- [21] Syukron, A. & Agus, S. (2018). Penerapan Metode Random Over-Under sampling dan Random Forest untuk Klasifikasi Penilaian Kredit. *Jurnal Informatika* Vol.5 No.2. hal: 175-185.
- [22] Thirunavukkarasu, K. S. & Dr. S. S. (2013). Analysis of Classification Techniques in Data Mining. *International Journal Of Engineering Sciences & Research Technology (IJESRT)*. ISSN: 2277-9655
- [23] Wang, Y. & Xuelei, S. N. (2019). Predicting Class-Imbalanced Business Risk Using Resampling, Regularization, and Model Ensembling Algorithms. *International Journal of Managing Information Technology (IJMIT)*. Vol. 11, No. 1
- [24] Wulandari, D. A., Dadan, K., Yudhi. (2019). Bagging Classification Trees untuk Klasifikasi Tingkat Kesejahteraan Rumah Tangga di Kalimantan Barat. *Buletin Ilmiah Math. Stat. dan Terapannya (Bimaster)*. Vol. 08, No. 4
- [25] Zhou, Z. H. (2012). *Ensemble Methods: Foundations and Algorithms*. CRC press

OUTLIER DETECTION ON STUDENT REPORT VALUES USING DENSITY-BASED APPROACH LOCAL OUTLIER FACTOR METHOD

Dinda Ayu Lara Saky¹, Ristu Haiban Hirzi²,
Lukmanul Hakim³

^{1,2,3}*Hamzanwadi University (INDONESIA)*
dalarasaky@gmail.com

Abstract

Databases do not always contain data objects that match the general nature or data model, but have different properties and characteristics. Outlier detection in big data is considered a difficult problem when compared to small datasets, where outlier detection techniques can be used to detect abnormal things or events. The population in this study were all student report cards of Madrasah Aliyah Nahdatul Wathan Lepak, while the sample used was the grades of student report cards in the subjects of Qur'an Hadith, History of Islamic Culture, Fiqh, Akidah Akhlak and Arabic in semester 1 class XII graduates from 2016 s/ d year 2020. The student report cards of Madrasah Aliyah Nahdatul Wathan Lepak have a low outlier density ranging from the 70s to 90s, so outlier detection will be carried out using a boxplot approach and density based Local outlier factor (LOF) method, where parameter selection becomes a decisive determinant. strong in determining the density value. The results showed that when univariate outlier detection was carried out using a boxplot approach, there was one variable that did not have outliers, namely the Qur'an Hadith variable. After analyzing outlier detection using a density based approach, the local outlier factor method obtained several outliers. With minPts 5 on the Qur'an Hadith variable there are 4 observations that can be said to be outliers. Based on this, the Local outlier factor method is able to detect outliers that cannot be detected by the boxplot.

Keywords: Outlier Detection, Value, Local Outlier Factor.

1 INTRODUCTION

The need for data processing is a very important thing in this era. In the field of education today, of course, it is necessary to better understand students, where according to [8] students who think that a subject is difficult gives a bad impression for students in learning, students tend to be less enthusiastic so that students' grades and achievements are not satisfactory. Therefore, with data mining the development of a particular method can find the uniqueness of a data that comes from the education system in the form of student scores or others. Meanwhile, the data can be processed by various data mining techniques such as association, classification, clustering and outlier detection [14].

Large amounts of data will be difficult to process when you want to analyze the errors contained in a data. Outliers are one of the problems that occur in data where the error in question is having different properties and characteristics from data in general and having relatively few occurrences of events or can be called exceptions [12][4][18]. According to [9] Outliers can be caused by varying data and errors at the time of data measurement. In addition, [10][15] argues that outliers are data deviations that are too far from other data or can be interpreted as outliers in a data series. The existence of this outlier data will make the analysis of a series of data biased, or not reflect the actual phenomenon. The term outlier is also often associated with extreme values, both large and small extremes that can interfere with data distribution. Moreover, [19] says that the impact that can be caused by the presence of outliers is a large residual from the formed model, the variance in the data becomes larger and the interval estimate has a wide range. The presence of outliers will make an analysis result biased or not in accordance with reality. Outlier detection is one of the techniques in data mining that aims to find data objects that have different properties and characteristics between most other data objects [7].

Outlier detection can be seen as a specific application of general data mining. The data mining process involves two steps: data

processing and data mining. The purpose of data processing is to make the data in good form, ie outliers are removed [1]. According to [17] outlier detection is an important step in data processing because, if outlier data points are used during data mining, it is likely to produce inaccurate output. Outlier detection in big data is considered a difficult problem when compared to small datasets. Of the many methods in outlier detection such as distribution based methods, depth based, deviation based, sub-space based, distance based, density based, clustering based, support vector based and neural network based, it is often not suitable to be applied in real data because real data usually has a distribution which are scattered and the objects are distributed in their characteristic space which is locally allocated randomly [12]. In particular, distribution-based methods [2] need to obtain a data distribution model to be tested first, which depends on the global distribution of the dataset, and does not apply to datasets with unequal distribution. The distance-based approach [13] requires the user to select reasonable distances, scale parameters and is less efficient on high-dimensional data sets. In the clustering method [20], outliers are not the target of the cluster so that abnormal points cannot be analyzed accurately. The above outlier detection methods all adopt global anomaly standards for processing data objects, which cannot work on datasets with uneven distribution. In practical applications, the distribution of data tends to be skewed, and there is a lack of indicators that can classify the data. Even if tagged data sets are available, their applicability to outlier detection tasks is often unknown [6]. However, the problem that often occurs in big data is that the data has high dimensions.

Density-based approach is a proximity-based method using various distance metrics [5], which is able to solve the problem of multi-cluster outlier detection effectively. LOF is an effective method for finding outliers and is actually based on the concept of a distance-based approach. However, the LOF algorithm produces a relative density [11]. Local outlier factor (LOF) is a density-based outlier detection algorithm that finds outliers by calculating the local deviation

of certain data points, which is suitable for outlier detection from unevenly distributed datasets. Determination of outliers is assessed based on the density between each data point and its neighboring points. The lower the density of a point, the more likely it is to be identified as an outlier [6].

Research conducted [12], to overcome the problem of scattered data distribution, he uses the Local Distance Based Outlier Factor (LDOF) method because this method is good for scattered data and LDOF measures the extent to which an object deviates from the scattered environment, but according to [7] detection results with density based approach are more accurate than distance based. Moreover, the data on student report cards at Madrasah Aliyah NW Lepak has a low outlier density, which can be seen from the student report cards as follows:

Table 1. Student Report Scores of Madrasah Aliyah NW Lepak graduates in 2016-2020

Number	Value	Frequency
1	74-76	110
2	77-79	88
3	80-82	95
4	83-85	54
5	86-88	28
6	89-91	24
7	92-94	3
Amount		402

Source: The Madrasah Aliyah NW Lepak

The data on student report cards at MA NW Lepak has a low outlier density, which can be seen from the data on student report cards ranging from the 70s to 90s, which can be seen in table 1, so the appropriate approach to detecting outliers in the data is density based. In the density based approach there are many methods, one of which is Local outlier factor (LOF). According to [16], by using the

LOF method, the data object of the MA NW Lepak student report card analyzed was not explicitly determined whether the object was an outlier or not, but gave a value to each object as the degree of strength that the object was said to be outlier or not.

2 METHODOLOGY

The type of research conducted in this research is quantitative research. In which, this research was conducted to answer research problems whose data are in the form of numbers and statistical programs [21].

This research was conducted at Madrasah Aliyah NW Lepak, where the subjects in this study were alumni students of Madrasah Aliyah NW Lepak in 2016-2020, totaling 402 people. The things studied were students who were different from the majority of other students by using the evaluation results of all Madrasah Aliyah NW Lepak students from the beginning of attending lessons to the end of the semester obtained from the Madrasah Aliyah NW Lepak, East Sakra sub-district, East Lombok Regency, West Nusa Tenggara. The variables used are 5 variables, namely Qur'an Hadith, Fiqh, History of Islamic Culture, Akidah Akhlak and Arabic. Where the five variables are subjects that have been taken (learn) by each student (observation).

Data analysis in this study used statistical data mining analysis. The data analysis technique used in this research is outlier detection technique using a density based approach, namely the local outlier factor (LOF) method. Where outlier analysis is known as outlier detection which is an analysis to find objects that are different from most objects in general. Density based approach does not classify an object explicitly whether it is an outlier or not, but rather assigns an object value as the degree of strength that the object can be categorized as an outlier. This measure of the degree of strength is called the local outlier factor (LOF). The outlier search approach only requires a parameter, namely MinPts (k). MinPts is the number of nearest neighbors used to define the local neighborhood of an object

[9]. The density-based local outlier detection method can effectively solve the problem of the need to adopt a global anomaly standard for processing data objects that cannot work on datasets with uneven distribution. The solution to this problem is stiffened by describing the degree of outliers from data points quantified with local density [6]. This local outlier factor method needs to calculate the LOF value of all data points but this is not necessary because there are only a few outliers in the dataset [3].

3 RESULTS

The data used in this research is data on report cards for MA NW Lepak students in semester 1 of class XII graduates from 2016 to 2020, where about 57% of the number of students are female, the remaining 43% are male. graduation, 14% of the students were 2016, 24% in 2017, 21% graduated in 2018, 20% graduated in 2019 and the remaining 21% graduated in 2020. From these two things it can be concluded that the majority of the gender of MA NW Lepak students graduated in 2016 /d in 2020 are women and the majority of students based on graduates are in 2017.

Outlier detection is done univariately using a boxplot, it can be seen that of the five variables, there is one variable that does not have outliers, namely the Qur'an Hadith variable. Based on this, outlier detection will be carried out using the local outlier factor (LOF) method to prove whether the local outlier factor method can detect outliers in variables that do not have outliers using a boxplot. The following are the results of the outlier detection analysis using the local outlier factor method:

3.1 Variable Qur'an Hadith

Detection of outliers carried out on the Qur'an Hadith variable using the LOF method, obtained 4 observations that can be called outliers using $\text{minPts} = 5$. Where among them are the 187th, 189th, 191st and 274th observations with outlier scores infinity. Here is the density plot of the Qur'an Hadith variable with $\text{minPts} = 5$:

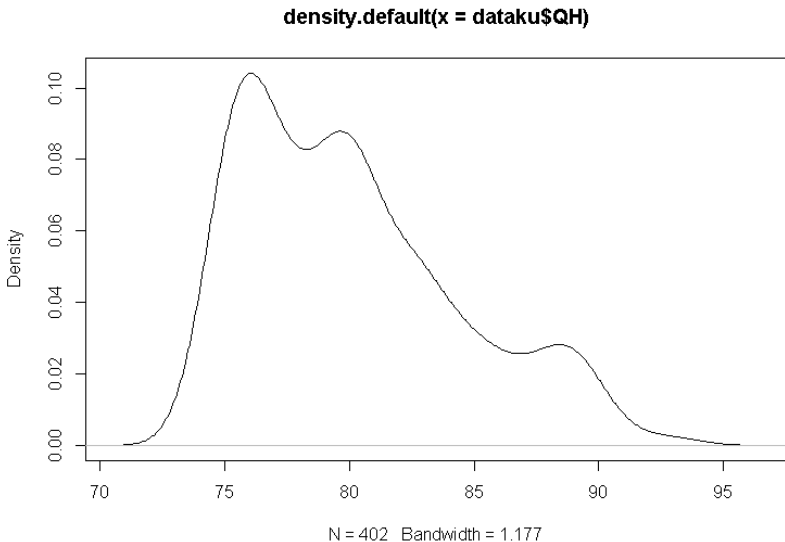

Figure 1. Plot density of Qur'an Hadith subjects

Figure 1 shows that in the plot there are 3 peaks. for example the first peak is around 0.13 at $x = 77$ which means about 13% of the value of the Qur'an Hadith subjects is around 77. Then the second peak is around 0.09 at $x = 80$ which means about 9% of the value of the Qur'an subjects. an Hadith around 80, and the last peak is around 0.03 at $x = 89$ which means about 3% of the scores of Qur'an Hadith subjects are around 89.

3.2 All Variables

The following are the 5 top outliers from the results of outlier detection using the local outlier factor minPts 5 method with all variables, namely the Qur'an Hadith, Fiqh, Islamic Cultural History, Akidah Akhlak and Arabic are as follows:

Table 2. Five top outliers using data on the value of all subjects with a minPts of 5

Observation	Outlier Score
189	2.569628
265	2.559312
350	2.38423
187	1.852113
190	1.807023

Table 2 shows the 5 top outliers along with the outlier scores from the five observations that are said to be top outliers, where observations are said to be outliers when the outlier score is one or more than one. From the table, it is known that the five observations have a high outlier score, which is more than one.

density.default(x = outlier.scores)

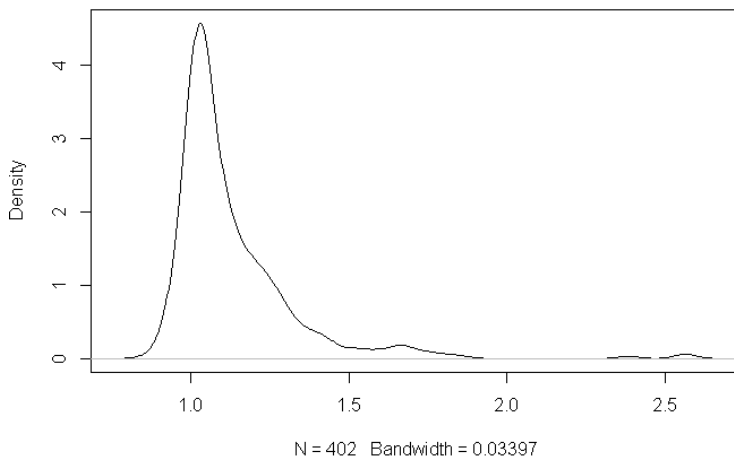

Figure 2. Density plot of all subjects minPts 5

Figure 2 shows that the plot has 3 peaks. for example, the first peak was around 4.9 at $x = 1.1$ which means that with a density of 4.9 the outlier score of religious subjects was around 1.1. Then the second peak is around 0.2 at $x = 1.7$ which means with a density of 0.2 the outlier score of religious subjects is around 1.7 and the third peak is around 0.1 at $x = 2.6$ which means that with a density of 0.1 the outlier score of religious subjects is around 2.6.

4 CONCLUSIONS

The local outlier factor (LOF) method is used to detect outliers in the student's report card score data by looking at the outlier score of each observation, where an observation can be said to be an outlier when the outlier score is close to a value of 1 or more than 1. Then use the local method. outlier factor (LOF) in detecting outliers is very possible because when detecting outliers univariately on all existing variables, there are variables that do not have outliers, namely the Qur'an Hadith variable, so outlier detection is carried out on both variables using the local outlier factor method. and the result is that in the Qur'an Hadith variable there are 4 observations that can be said to be outliers when using $\text{minPts}=5$. While in all variables there are 5 top outliers, namely the 189th, 265th, 350th, 187th and 190th observations which can be called outliers using $\text{minPts}=5$ and the outlier scores obtained are very high, namely 2.569628, 2.559312, 2.38423, 1.852113 and 1.807023.

REFERENCES

- [1] Alghushairy, O., Alsini, R., Soule, T., & Ma, X. (2021). A Review of Local Outlier Factor Algorithms for Outlier Detection in Big Data Streams. *Big Data and Cognitive Computing*, 5(1), 1.
- [2] Aviles J. E. A., Maria Isabel Cordero Marcos, David Sasaki, Keith Sutherland, Bill Kane, and Esa Kuusela. 2018. *Creation of knowledge-based planning models intended for large scale distribution: Minimizing the effect of outlier plans*. Journal of applied clinical medical physics 19, 3, 215–226.

- [3] Breunig, Markus M, Hans-Peter Kriegel, Raymond T Ng, and Jörg Sander. (2000). *LOF: identifying density-based local outliers*. In ACM sigmod record, Vol. 29. ACM, 93–104.
- [4] Brilliant, Felisitas. 2014. *Deteksi Outlier Menggunakan Algoritma Local Correlation integral (Studi Kasus: Data Akademik Mahasiswa Teknik Informatika Universitas Sanata Dharma)*. Skripsi, Universitas Sanata Dharma Yogyakarta.
- [5] Chandola, V., A. Banerjee, and V. Kumar. 2009. *Outlier Detection: A Survey*. ACM Computing Surveys, vol. 41, no. 3, pp. 1-58.
- [6] Cheng, Z., Zou, C., & Dong, J. (2019, September). *Outlier detection using isolation forest and local outlier factor*. In *Proceedings of the conference on research in adaptive and convergent systems* (pp. 161-168).
- [7] Handriyadi, Dedy, M. Arif Bijaksana & Erwin B.S.. 200). *Analisis Perbandingan Clustering-Based, Distance Based dan Density Based dalam Mendeteksi Outlier*. Yogyakarta: Seminar Nasional Aplikasi Teknologi Informasi.
- [8] Hirzi, R. H., Sripatmi, S., & Hapipi, H. 2015. *Penerapan model pembelajaran kooperatif tipe snowball throwing pada pembelajaran segiempat untuk meningkatkan aktivitas dan prestasi belajar siswa smpn 1 lingsar kelas vii-1 tahun pelajaran 2012/2013*. *Jurnal pijar MIPA*, 10(1).
- [9] Jiawei, Han & Kamber M.. 2006. *Data Mining Concept and Techniques*. Amsterdam: Elsevier.
- [10] Laksono, M. A. T., Yudha Purwanto, Astri Novianty. 2015. *Analisis Sistem Deteksi Anomali Trafik Menggunakan Algoritma Clustering Cure (Clustering Using Representatives) Dengan Outlier Removal Clustering Dalam Menangani Outlier*. e-Proceeding of Engineering : Vol.2, No.2 page 3800.
- [11] Ma, M. X., Ngan, H. Y., & Liu, W. 2016. *Density-based outlier detection by local outlier factor on largescale traffic data*. *Electronic Imaging*, 2016(14), 1-4.

- [12] Maulana, Yudhi, Mahmud Imrona & Hetti Hidayati. 2013. *Analisis dan Implementasi Local Distace Based Outlier Factor dalam Mendeteksi Outlier pada Data Numerik*. Prosiding Konferensi Nasional Matematika, Sains dan Aplikasinya.
- [13] Pang, G., Longbing Cao, Ling Chen, and Huan Liu. 2018. *Learning representations of ultrahigh-dimensional data for random distance-based outlier detection*. In Proceedings of the 24th ACM SIGKDD International Conference on Knowledge Discovery & Data Mining. ACM, 2041–2050.
- [14] Prabowati, Setyo Resmi & Paulina H.P.R.. 2013. *Deteksi Outlier Menggunakan Algoritma Naïve Nested Loop (Studi Kasus: Data Akademik Mahasiswa Program Studi PS Universitas XYZ)*. Prosiding Seminar RiTekTra.
- [15] Purwanto Y, Kuspriyanto, Hendrawan, Budi Rahardjo. 2014. *Traffic Anomaly Detection in DDos Flooding*. International Conference on Telecommunication Systems Services and Applications(TSSA), vol. 8, pp. 313-318.
- [16] Raharjo, Daniel Tomi. 2013. *Deteksi Outlier Menggunakan Algoritma Local outlier factor (Studi Kasus Data Akademik Mahasiswa TI Universitas Sanata Dhrama)*. Skripsi, Universitas Sanata Dharma Yogyakarta.
- [17] Ramírez-Gallego, S.; Krawczyk, B.; García, S.; Woźniak, M.; Herrera, F. 2017. *A survey on data preprocessing for data stream mining: Current status and future directions*. Neurocomputing, 239, 39–57.
- [18] Ruwidati, Yustina Ayu. 2014. *Deteksi Outlier Menggunakan Algoritma Connectivity Based Outlier Factor (Studi Kasus: Data Akademik Mahasiswa Teknik Informatika Universitas Sanata Dharma)*. Skripsi, Universitas Sanata Dharma Yogyakarta.
- [19] Soemartini. 2007. *Pencilan (Outlier)*. Universitas Padjajaran Jatinangor.

- [20] Verma, P., Prashant Singh, and RDS Yadava. 2017. *Fuzzy c-means clustering based outlier detection for SAW electronic nose*. In 2017 2nd international conference for convergence in technology (I2CT). IEEE, 513–519.
- [21] Wahidmurni. 2017. *Pemaparan Metode Penelitian Kuantitatif*. UIN Maulana Malik Ibrahim Malang.

ANALYSIS THE EFFECT OF LINK BUILDING USING SOCIAL MEDIA ON MULTI UMAH WEBSITE

Diah Aryani¹, Shine Pintor Siolemba Patiro², Aji Setiawan³

^{1,3}Universitas Esa Unggul (INDONESIA)

²Universitas Terbuka (INDONESIA)

diah.aryaniesaunggul@esaunggul.ac.id

Abstract

Utilization of Search Engine Optimization (SEO) on websites is a method which aimed to increase the presence and number of visitors to a website so that they can be indexed by search engines and get a position on the results of the Search Engine Result Page (SERP). The number of social media users in Indonesia increases on January 2021 with a total of 170 million or equivalent to 61.8% of the total population. it has an effect on increasingly activities and interactions virtual towards using various social media platforms, even it was integrated into various activities such as marketing business. Using social media has the advantage of reaching customers broadly and quickly. This study aims to analyze the use of SEO method with off page optimization techniques that emphasize link building by using social media to direct visitors to the Umah Multi website. The number of internet users in searching for various needs through search engines, with link building websites, could get good rankings on search engines based on the relevance of customer interest traffic to the product. So that, easily, customers can find products or businesses through search engines, even with link building marketers could understand customer behavior based on traffic quality, and the data determining social media selection for further marketing.

Keywords: Search Engine Optimation, Link Building, Search engine Result Page, white had, off page

1 INTRODUCTION

Utilization of Search Engine Optimization (SEO) on websites is a method which aimed to increase the presence and number of visitors to a website. Thus, they can be indexed by search engines and get a position in the results of the Search Engine Result Page (SERP) and achieve visibility [1]. Furthermore, to achieve visibility in digital era, the use of SEO has become a necessity for every institution. This could be seen from search engines that high rankings could be a source of information for 4.2 billion internet users with the number of searching on Google. Four billion with an average of 51% of websites whose traffic comes from organic search [2], more than half of the traffic to websites channeled via search engines. So, high ranking on search engines means making the website as a referral agency. That's why Google ranking is very important, because of its search engine market share is 92.42%.

Since June 2019, The new paradigm occurred when more than half (50.3%) of browser which searching based on Google generated no clicks to websites. Furthermore, Google responds to search queries, especially those from mobile devices, without clicking on any of the results. So it can be said that Google is trying to serve users through direct answers for every question in the SERP which is searching result without going through a click that goes to Google's property increased (ibid). According to Fishkin, Google's behavior has changed, from being a search engine that showed searchers to get answers to the websites, become a machine that can provide solutions and answers to engine questions [3].

According to the Datareportal website, internet users in Indonesia are 202.6 million or around 73.7% of the total population in 2021. Moreover, around 41.6% were acquired from existing internet users, looking for products through the website. It also happened, the number of social media users in Indonesia increased on January 2021 with a total of 170 million or equivalent to 61.8% of the total population. It has an impact on activities and interactions turning towards virtual using various social media platforms. Social media is increasingly attracting

people to fill activities. Even it becomes an important part of everyday life and people prefer to interact virtually on various platforms such as Facebook, Instagram, LinkedIn, & Twitter. Most of them realize that social media could be applied to the marketing process, because it can improve communication between companies and customers [4]. Some communities actively communicate on social media, while others adapt. They manage all corporate communications using social media, and it is the most effective way so that social media becomes very important in entrepreneurship [5].

Link building using social media can build excellent quality links [5]. So that it can improve the quality of traffic to the website. From these results link building has an important effect on the ranking of a site on search engines, because this technique can help search engines understand the level of site popularity on search engines [6]. According to Google's Search Engine Optimization (SEO) Beginner's guide, "link building is a work of art, it is the most challenging part of any SEO work, but also the most important for success" [7].

Umah Multi (UM), is a Micro, Small and Medium Enterprise (UMKM) which engaged in digital printing services, graphic design and website creation. UM has a website with the domain umahmulti.biz.id as its marketing medium. But the website has not been indexed on search engines, because the website has not implemented the SEO. Thus, this study aims to analyze the effect of link building using social media on the UM's website by applying SEO method with off page optimization techniques. This technique fosters that link building on social media direct visitors to the UM's website in order to increase its website index on search engines and get a position on the results of the Search engine Result Page (SERP).

2 METHODOLOGY

This study used descriptive qualitative research design. We implemented white hat SEO to umahmulti.biz.id with off page optimization techniques with an emphasis on link building on social media. Off page optimization of the umahmulti.biz.id website will be

focused on link building using social media as a marketing medium to strengthen the image of the web. A brief description of the off page implementation can be seen in the following image:



Figure.1 Flow of link building implementation

2.1 Data Analysis and Social Media

This stage is needed to find out how UM's ability to provide data as a content material. In accordance with its line of business, Umah Multi is able to provide data in the form of images and text as promotional materials. Social media was observed using the Datareportal site as a reference, the acquisition of social media platforms that are widely used by internet users in Indonesia can be seen in Figure 2. Based on the type of data used provided by Umah Multi, link building is applied to social media such as Facebook, LinkedIn and Twitter.

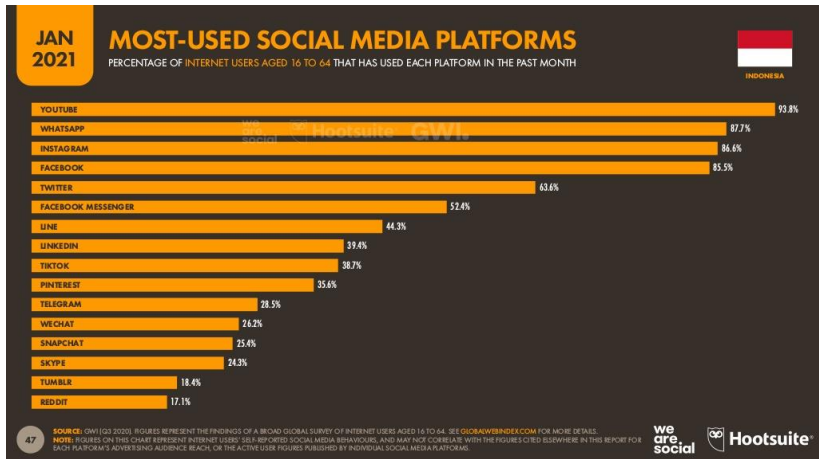

Picture. 2 Acquisition of social media platforms

Source: <https://datareportal.com/reports/digital-2021-indonesia>
 accessed on February 25, 2021

2.2 Implementation

Link building is implemented by inserting a URL in the content. Social media will read and understand the content based on the contents of the meta tags that have been applied. This content plays an important role in communication between the website and search engines.

2.3 Traffic Data Analysis

Traffic will be analyzed using Google Analytics with several parameters that used as a reference to understand user behavior, namely the number of sessions, page sessions, session duration and bounce rate based on other research [5]. However, the Google Analytics used by UM has a slight difference because the version which used. The parameters will be adjusted to the needs. White hat SEO needs a long time to develop. So, regular maintenance is needed in further development to maintain SERPs rankings, thereby traffic increased on an ongoing basis.

The following figure is a brief description of data based on Google Analytics regarding the analysis of user interests and behavior in finding UM's businesses Using social media Facebook, Twitter, LinkedIn. Thus, it can be determined which social media is suitable for product marketing.

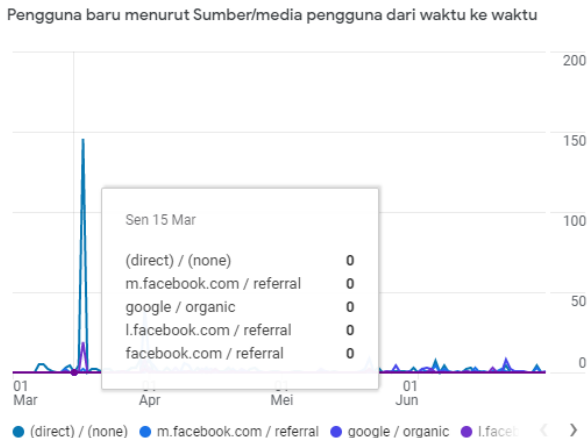
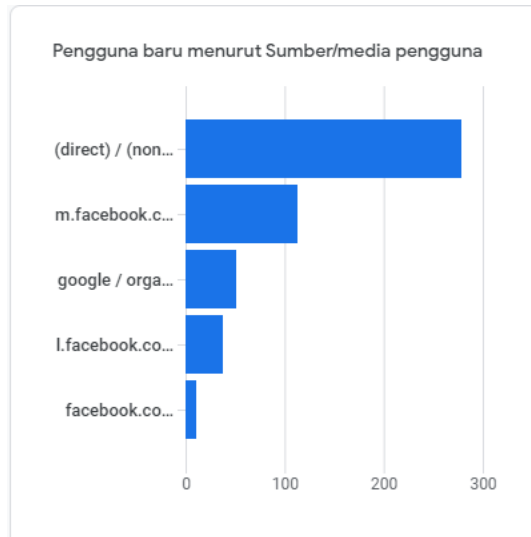

Figure 3 Google Analytics traffic

Source: <https://analytics.google.com/analytics/web>
accessed on 26 July 2021.

Figure 3 is The line graph which shows the highest traffic activity from time to time comes from direct, which means direct access through the UM's website address



*Figure 4. The top 5 sources / media that bring traffic to the umahmulti.biz.id website.
Source: <https://analytics.google.com/analytics/web>
accessed on 27 July 2021.*

Figure 4 is The bar graph which shows the 5 highest session sources/media, namely direct, search engines (organic search), and Facebook with 3 different URL addresses.

*Table 1. Data regarding media sources/sessions.
Source: <https://analytics.google.com/analytics/web>
accessed on 27 July 2021*

Sumber/media sesi	Pengguna	Sesi	Sesi engagement	Waktu engagement rata-rata per sesi	Sesi engagement per pengguna	Peristiwa per sesi	Rasio engagement	Jumlah peristiwa
(direct) / (none)	268	328	91	0m 34d	0,34	6,98	27,74%	2289
google / organic	59	121	84	2m 30d	1,42	13,67	69,42%	1654
m.facebook.com / referral	112	120	88	0m 13d	0,79	4,76	73,33%	571
l.facebook.com / referral	40	71	39	2m 00d	0,98	16,44	54,93%	1167
linkedin.com / referral	7	31	19	0m 37d	2,71	7,84	61,29%	243
sgx19.dewaweb.com:2083 / referral	1	21	18	6m 59d	18	29,48	85,71%	619
l.instagram.com / referral	3	19	16	3m 44d	5,33	32,89	84,21%	625
t.co / referral	8	13	9	0m 25d	1,13	12,85	69,23%	167
facebook.com / referral	11	11	10	0m 12d	0,91	5,27	90,91%	58
lm.facebook.com / referral	5	9	4	0m 11d	0,8	5,44	44,44%	49
support.google.com / referral	3	4	3	2m 25d	1	17	75%	68
lnkd.in / referral	3	3	0	0m 00d	0	3	0%	9
bing / organic	2	2	2	0m 11d	1	5,5	100%	11
easyhits4u.com / referral	2	2	0	0m 00d	0	3	0%	6
web.facebook.com / referral	1	2	1	0m 05d	1	3	50%	6
(not set) / (not set)	8	1	0	0m 55d	0	11	0%	11
bradlevlive.xyz / referral	1	1	0	0m 00d	0	3	0%	3
dewaweb.com / referral	1	1	1	0m 10d	1	11	100%	11
free.facebook.com / referral	1	1	0	0m 00d	0	3	0%	3
id.search.yahoo.com / referral	1	1	1	0m 17d	1	5	100%	5
qwrnl.aucoinhomes.com / referral	1	1	0	0m 00d	0	3	0%	3
yahoo / organic	1	1	1	0m 00d	1	4	100%	4

a. Facebook

Traffic generated from Facebook consists of 6 different URLs, here's a description of the traffic sources.

m.facebook.com/referral generated 112 active users with 120 sessions. User interest resulted in 88 engagement sessions with an average duration of engagement of 13 seconds and 0.79 engagement sessions per user, and has an engagement ratio of 73.33%. Then the generated events per session have a value of 4.76 for a total of 571 events.

l.facebook.com/referral generates 40 active users with 71 sessions. User interest resulted in 39 engagement sessions with an average duration of engagement of 2 minutes and 0.98 sessions per user engagement, and has an engagement ratio of 54.93%. Then the generated events per session have a value of 16.44 for a total of 1167 events.

Facebook.com/referrals generates 11 active users with 11 sessions. User interest resulted in 10 engagement sessions with an average duration of 12 seconds of engagement and 0.91 engagement sessions per user, and an engagement ratio of 90.91%. Then the events generated per session have a value of 5.27 for a total of 58 events.

lm.facebook.com/referral generates 5 active users with 9 sessions. User interest resulted in 4 engagement sessions with an average duration of engagement of 11 seconds and 0.8 engagement sessions per user, and has an engagement ratio of 44.44%. Then the events generated per session have a value of 5.44 for a total of 49 events.

web.facebook.com/referral generates 1 active user with 2 sessions. User interest resulted in 1 engagement session with an average duration of engagement of 5 seconds and 1 engagement session per user, and has an engagement ratio of 50%. Then the events generated per session have a value of 3 for a total of 6.

free.facebook.com/referral generates 1 active user with 1 session. User interest resulted in 0 engagement sessions with an average duration of engagement sessions of 0 seconds and 0 engagement sessions per user, and has an engagement ratio of 0%. Then the events generated per session have a value of 3 for a total of 3.

b. LinkedIn

Traffic generated from LinkedIn consists of 2 different URLs, the following is a description of the traffic source.

LinkedIn.com/referral generated 7 active users with 31 sessions. User interest resulted in 19 engagement sessions with an average duration of engagement of 37 seconds and 2.71 engagement sessions per user, and has an engagement ratio of 61.29%. Then the events generated per session have a value of 7.84 for a total of 243 events.

lnkd.in/referral generates 3 active users with 3 sessions. User interest resulted in 0 engagement sessions with an average duration

of engagement sessions of 0 seconds and 0 engagement sessions per user, and has an engagement ratio of 0%. Then the events generated per session have a value of 3 for a total of 9.

c. Twitter

Traffic generated from Twitter consists of only 1 different URL, here is a description of the traffic source.

t.co/referral generated 8 active users with 13 sessions. User interest resulted in 9 engagement sessions with an average duration of engagement of 25 seconds and 1.13 engagement sessions per user, and has an engagement ratio of 69.23%. Then the events generated per session have a value of 12.85 for a total of 167 events.

3 CONCLUSIONS

The research results are based on google analytics traffic data which obtained by optimizing link building using social media facebook, linkedin & twitter. Facebook social media has a strong influence in marketing of UM's products which compared to other social media. This because of the quality of traffic which generated from the application of link building on Facebook. It has a very good average user, session, duration and engagement which compared to other social media tested. The results show that Facebook users have an interest in the products marketed by UM. Thus, they can strengthen marketing with Facebook and get traffic that continues to increase. Moreover, it could also increase website rankings on search engines.

The development of a system is definitely needed in order to maintain stability and keeping pace with technological developments. Thus, further research is needed for analysis of increasing brand awareness of customers by implementing white hat SEO using Google My Business tools to encourage customer ratings and trust.

ACKNOWLEDGEMENTS

The researchers would like to thank the parties who have assisted in the implementation of this research, namely Umah Muti, Esa Unggul University and the Universitas Terbuka.

REFERENCES

- [1] A. Yalcin, N., & Kilic, "A comparison of private university websites in Ankara according to their search engine optimizations.," *AJIT-e; Istanbul*, vol. 7, no. 23, pp. 55–66, 2016.
- [2] BrightEdge Research, "BrightEdge's report," 2017.
- [3] N. Krstić, "DOES GOOGLE FAVOUR ITS OWN PLATFORMS IN SEARCH VISIBILITY?," in *PAPERS FROM THE THEMATIC AREAS OF THE CONFERENCE, 2020*.
- [4] and R. A. A. Alalwan, N. P. Rana, Y. K. Dwivedi, "Social media in marketing: A review and analysis of the existing literature," *Telemat. Informatics*, vol. 34, no. 7, 2017.
- [5] T. Grizane and I. Jurgelane, "Social Media Impact on Business Evaluation," in *in Procedia Computer Science*, 2016.
- [6] A. Kumar, "Search Engine Optimization (SEO): Technical Analysis Concepts," *Int. J. Emerg. Technol. Adv. Eng*, vol. 3, no. 3, 2013.
- [7] S. Z. and N. Cabage, "Search engine optimization: Comparison of link building and social sharing," *J. Comput. Inf. Syst*, 2017.

DEVELOPMENT OF WEB-BASED FACILITY SURVEY SYSTEM IN COLLEGE OF VOCATIONAL STUDIES IPB UNIVERSITY

**Walidatush Sholihah¹, Fendrina Yoarbanu Tjitra²,
Wina Yulianty³, Nur Aziezhah⁴**

*¹Computer Engineering, College of Vocational Studies, IPB
University (INDONESIA)*

*^{2,4}Informatics Management, College of Vocational Studies, IPB
University (INDONESIA)*

*³Chemistry, College of Vocational Studies, IPB University
(INDONESIA)*

walidah@apps.ipb.ac.id

Abstract

The Education Commission is one of the units in College of Vocational Studies IPB University (SV IPB) which has tasks such as evaluating the results of academic activities. One of the things that the Education Commission needs to evaluate is the facilities and services that support lecture activities. The assessment is carried out by means of a survey, where every lecturer, education staff, and student fills out the survey every semester. The results of the survey are processed to determine improvement policies. SV IPB has many facilities and services. Therefore, in order for the survey to run smoothly, a web-based survey application was created. This application can be accessed anywhere as long as it is connected to the internet. The method used in the process of making the system is the agile method. The system is built using the codeigniter framework and the PHP programming language. Users of this system consist of the Education Commission, lecturers, education staff, and students. Testing on the system is carried out by the Black Box Testing method. After doing the testing, it was concluded that each function has been running according to plan. The system can already be used to create surveys, fill out surveys, and download survey results.

Keywords: agile, facility, satisfaction, services, survey, web.

1 INTRODUCTION

Bogor Agricultural University, as one of the universities in Indonesia, has held Diploma education since 1979. Currently, the Diploma program at IPB is organized by the Vocational School. There are 17 study programs under the IPB Vocational School consisting of agriculture, plantation, fishery, animal husbandry, communication, environment and technology. Every year, the number of students who attend lectures at SV IPB reaches 6000 students.

Vocational education prioritizes practical activities more than lecture activities in theory. Practical activities need to be supported by adequate facilities. In addition to facilities, services to students, especially those related to academics, are very important. Parasuraman (1998) in Indrawati (2011) suggests five basic dimensions of quality. The dimensions are: (1) reliability, is a reliable ability; (2) Responsiveness, is the willingness to provide service and help the consumer immediately; (3) Assurance, that is, the knowledge and ability that employees have in providing services so the customers feel comfortable with the services; (4) Empathy, is an important concern for the customer; (5) tangible, is the appearance of physical facilities, equipment / medium and communication media [1]. Education and teaching activities at SV IPB are regulated by the Education Commission.

The Education Commission is one of the units in SV IPB. The Education Commission has duties, such as carrying out socialization of the rules for new students, evaluating teaching and learning outcomes, evaluating academic activities, help student graduation process. Every semester, the Education Commission conducts evaluations aimed at increasing the quality score in SV IPB.

One of the evaluations carried out by the Education Commission was an evaluation of the existing facilities at the IPB Vocational School. The facilities consist of academic units and services, facilities and infrastructure, services, laboratories, and libraries. One way to improve the service is to conduct a satisfaction survey [2]. Evaluation is carried out by conducting a survey to lecturers, education staff, and

students as respondents. This survey activity is carried out once a semester. Surveys are one of the methods used to obtain data from a place naturally, by collecting data such as questionnaires, tests, or interviews [3]. Customer satisfaction survey is a standard method used by service providers in order to obtain feedback from the customer as well as close the gap between customer expectation and perception of service quality [4]. Customers' expectations represent their standard by making a perception of real life [5]. The results of this survey are reported to the management of SV IPB for follow up.

Previously, survey activities were conducted online via Google Forms. Each unit creates a form that can be filled out by lecturers, students and staff. This raises problems such as the survey forms are becoming more numerous (not centralized yet). Respondents are sometimes confused because there are many links that need to be filled in. This survey activity needs to be carried out centrally so that survey results are easier to trace and respondents to fill out more easily. Therefore, a system was developed to deal with this problem.

The facility satisfaction survey system allows respondents to complete surveys in one place. The survey is conducted online, so that filling out the survey can be done anywhere and anytime. In addition, this system has features for managing questions, determining survey schedules, and determining question categories to be displayed on the survey page later. Survey results are displayed in the form of graphs and survey results data can be downloaded in Excel file format. In this system, there is also a study program chart to monitor which study program members have filled out the survey.

2 METHODOLOGY

The method used in making the Web-Based Facility Satisfaction Survey application at the IPB Vocational School is the agile methodology. agile project is much better than other software development process in terms of productivity, performance, faster time cycles, risk analysis [6]. The agile software development methodology is focused around a short iterative software release cycle

[7]. Agile software development methods are considered lightweight methods that could employ an incremental and iterative lifecycle accompanied with short requirements and iterations, which could be modified within the development with broad participation by the customer [8]. The agile method applies an iterative process where every feature addition or change is carried out in the next iteration [6]. The principle in this agile method is that software developers are motivated and empowered and create business value by providing working software to users on a regular basis [9]. The main point in the agile methodology is the interaction with the client and agile is suitable for short or medium term projects [10]. In addition, agile has good documentation and is adaptive where changes can occur at the end of iteration [11]. Figure 1 is an illustration of several stages in the agile methodology. The stages are planning, design, develop, test, release, and feedback.

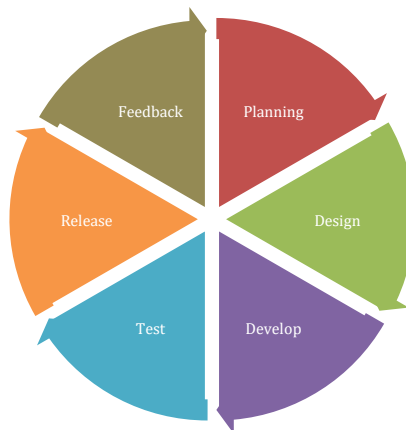

Figure 1. Agile Method.

The first stage in the agile method is planning or planning stage. At this stage the developer discusses with the client about the system he wants to build, such as determining the main features, functionality, and desired output results. After the planning stage, the next stage is

design. The design stage is the stage for designing data using the Unified Modeling Language (UML) modeling method which consists of use case diagrams and class diagrams. The third stage is the develop stage, where at this stage the developer codes the system using the PHP programming language with the Codeigniter 4 framework and MySQL database. Next, enter the testing phase which is carried out using the Black Box Testing method with the aim of preventing bugs or failures in the system and testing the input and output results as expected [12]. Black box testing aims to see the functionality of a program without looking at the program code used [13]. The last stage in the agile method, namely release and feedback. At this stage, the system is handed over to the client after being tested and asks the client to provide feedback on the system. If there are changes or additions to the system, then the work process is carried out in the next round. But if there are no changes or additions, then the system is ready to be launched.

3 RESULTS

The process of making a web-based facility satisfaction survey system in Vocational Schools uses an agile methodology. The manufacturing process undergoes two iterations. Each iteration of the agile methodology has six stages consisting of planning, design, develop, test, release, and feedback.

1.2.1 Planning

Planning is the initial stage in agile methodology. At this stage the developer conducts discussions with the client. The results of these discussions become material for analysis of requirements on the system both functionally and non-functionally.

The Facility Satisfaction Survey System at the IPB Vocational School is a system that is intended to make surveys, fill out surveys, and retrieve survey results. This system has five actors, namely super admin, admin, lecturers, education staff, and students. Super admin has a role in managing, viewing and downloading survey results. In

addition, admins can only view and download survey results according to the unit. Furthermore, lecturers, education staff, and students are the respondents of the survey. The survey is only carried out once in a semester. In addition, there is also a feature to download the number of survey respondents for the Education Commission, which can view the data again offline and filter the graph of survey results based on respondents.

Functional requirements are made to describe the functions that exist in the system [14]. The functional requirements needed in this system, namely a login process before entering the website, providing a graph and table to present survey results, a feature to download survey results, a validation process for survey fillers, and a feature provided for education commissions to manage questions, schedules, and admin data. Non-functional requirements are used to support the features of the system. There are three non-functional requirements needed in this system, which can be run on at least two different web browsers, have validation for each input process, and display an alert box every time you want to delete data. These three needs can be seen in Table 1.

Table 1. Non-functional Needs.

Function	Description
<i>Probability</i>	The system can be run on various web browsers including Google Chrome and Internet Explorer
<i>Reliability</i>	The system has a login function for super admins and admins to enter the system, as well as a validation form to fill out surveys
<i>Usability</i>	The system displays a warning box before wanting to delete a data

1.2.2 *Design*

After analyzing the needs of the system, the next step is making use case diagrams and class diagrams. The use case diagram aims to provide an overview of the interaction between actors and the information system that has been created. In the Facility Satisfaction Survey System there are five actors, namely super admin, admin, and respondents (lecturers, education staff, and students). Use case diagrams for super admins and admins can be seen in Figure 2 and diagrams for respondents are shown in Figure 3.

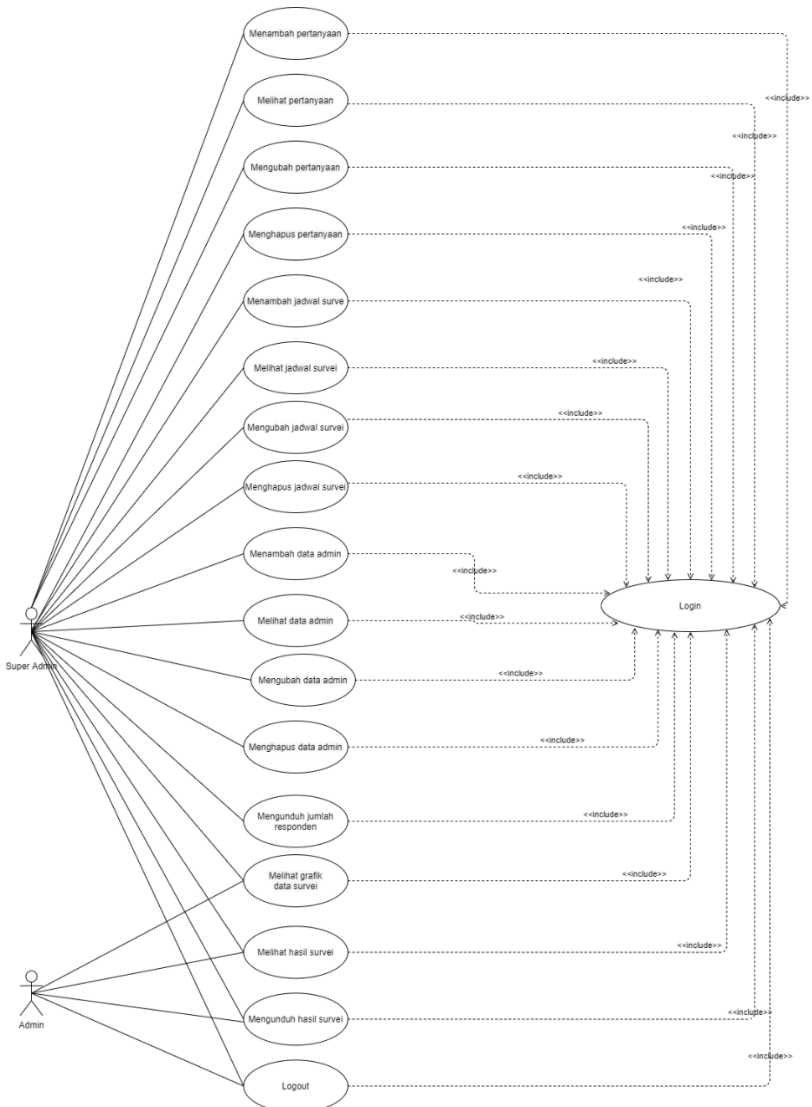

Figure 2 Use case diagram for super admin and admin

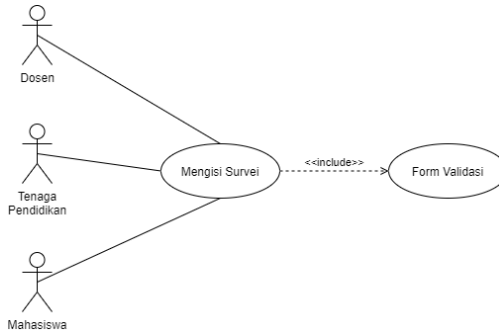

Figure 3. Use case diagram for respondent.

Class diagram defines classes as the structure of the existing system in the system. The class diagram in the first iteration has 11 classes, where each class is connected to each other. Figure 4 shows the relationship that each class has which is divided into two parts. The first part, the users_groups class is linked to the groups and users classes. Each users_groups can have one or more groups and users. The second part, the hsl_survey class has one or more relationships with the schedule class and the question class. Besides being connected to the hsl_survei class, the schedule class is also connected to the category class, tb_tendik, and tb_dosenmhs. The study program class is connected to the tb_dosenmhs class with each lecturer and student having only one study program. Furthermore, the question class is connected to the unit and category classes. Based on the picture, each question can only have one unit and one category.

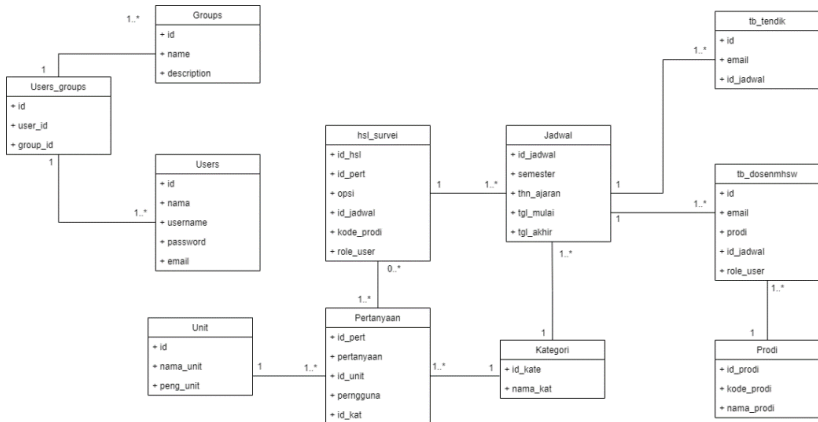

Figure 4. Class Diagram.

1.2.3 Develop

At the develop stage, the developer begins to carry out the coding process according to the functional requirements that have been determined at the planning stage. The first function that is done on the system is to create a login function for super admins and admins. The super admin in this system is the head of the education commission and the admin is a member of the education commission. Super admins and admins are asked to enter the username and password that have been specified on the login form before entering the system.

The function to add questions is intended for super admins to add survey questions. Super admins can fill in the add question form by filling in the question, the question unit, the user of the question and the category of the question. Questions that have been added can be seen on the survey content page. The question viewing function is made for super admins to view the list of questions that have been added to the system. The next function is to change the question. This function is here for super admins to be able to change the question data if there is an error during the data input process.

The delete question function is used for super admins to delete questions that are no longer needed. The next function is to add a

schedule. This function is used by the super admin to determine the start date of the survey and the end date of the survey. In addition to determining the start and end dates of the survey, the add schedule form contains the filling in the semester, school year and survey category that will be displayed. After adding a schedule, the super admin can see the list of schedules that have been added to the system.

The next function is to change the schedule. This function is used by the super admin if an error occurs during the input process and wants to fix it. In addition, this function can make super admins extend the survey filling time by changing the survey end date. The next function is to delete the schedule. This function is used by the super admin if you want to delete a survey schedule that is no longer needed. If the schedule is deleted, the survey results on the relevant schedule are also deleted from the system.

The add admin function is used by super admins to give admin permissions for each unit. The super admin will be asked to fill in the admin name, username, email address and password on the add admin form. The next function is to see the admin. This function is used by the super admin to see the admin of each unit that has been registered on the system. The admin change function is used by super admins to change admin data if an error occurs in the input process or the admin unit has forgotten the password. The delete admin function is used by super admins to remove admin or remove admin privileges from the system.

The next function is to view the survey graph which serves to view the survey results in graphic form. The graph on the super admin page displays a survey graph based on the study program and also the role of the user. User roles on the graph are divided into two, namely lecturers and students. Meanwhile, study programs are written according to the code of each study program. In addition, the chairman of the Education Commission as a super admin can see the information at the bottom of the graph. The survey results for the admin unit are presented in the form of a donut chart containing the

number of fillers for each available option. The view survey results function is used to see the number of people who chose each of these options and is presented in tabular form. The table consists of nine columns consisting of numbers, questions, answer options (very good, good, not good, and very bad), respondents, semester, and school year. The next function is to download the survey results. This function was created using a plugin from DataTables. The downloaded survey results file is saved in Excel format.

The next function is form validation for lecturers. This form serves to avoid using the same email address in one period. The form can only be accessed during the survey. The next function is form validation for education personnel. This form serves to avoid using the same email address in one period. The form can only be accessed during the survey. The next function is form validation for students. This form serves to avoid using the same email address in one period. The form can only be accessed during the survey. The last function is to fill out a survey, which is a place for respondents to provide answers to questions that have been provided on the survey content page. The graphical display of the survey results can be seen in Figure 5.

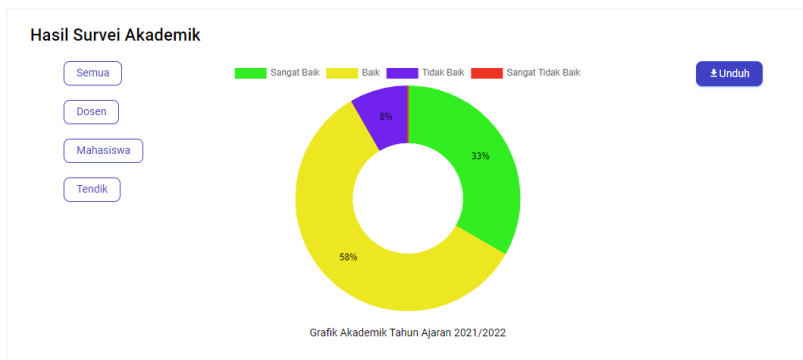

Figure 5. Survey Results Graph.

1.2.4 Test

After the development stage, the next step is to enter the testing stage with the Black Box Testing method. The developer presents the system results to the client to see if the functions are working properly. The test results are shown in Table 3.

Table 1. Testing Results.

Function	Testing Scenario	Expected Results	Testing Results
<i>Login</i>	The actor enters the registered username and password	Go to the main page of the website	Berhasil
Adding a survey question	Fill in all fields correctly on the form	Displaying questions that have been added on the question list page	Berhasil
View survey questions	Select the question list menu	Displays the question list page	Berhasil
Change survey questions	Changed some parts of the question data	Showing modified questions	Berhasil
Delete survey questions	Pressing the "Delete" button on the confirmation box	Delete a question from the questionnaire and database	Berhasil
Add survey schedule	Fill in all fields correctly on the form	Displays the survey schedule that has been	Berhasil

Function	Testing Scenario	Expected Results	Testing Results
		added on the schedule page	
View survey schedule	Selecting the survey schedule menu	Showing the survey schedule page	Berhasil
Change the survey schedule	Changed some parts of the survey schedule data	Showing the modified schedule	Berhasil
Delete a survey schedule	Pressing the "Delete" button on the confirmation box	Delete a schedule from the survey schedule page and database	Berhasil
Add admin unit	Fill in all fields correctly on the form	Displaying the admin that has been added on the admin list page	Berhasil
View admin unit	Choose the admin list menu	Show admin list page	Berhasil
Change admin unit	Changed some parts of admin data	Showing admin data that has been changed	Berhasil
Remove admin unit	Pressing the "Delete" button on the confirmation box	Remove admin from admin list and database	Berhasil

Function	Testing Scenario	Expected Results	Testing Results
Viewing a graph of survey data	Choose the main menu of the website	Displaying survey results in the form of pie charts and donut charts	Berhasil
View survey results	Selecting the survey results menu	Showing the survey results page	Berhasil
Download survey results	Pressing the "Download" button on the survey results page	Survey results have been successfully downloaded in Excel format	Berhasil
Lecturer validation form	Fill in an email address that has never been used to fill out a survey and choose a study program	Go to the survey content page	Berhasil
<i>Education staff validation form</i>	Fill in an email address that has never been used to fill out a survey	Go to the survey content page	Berhasil
<i>Student validation form</i>	Fill in an email address that has never been used to fill out a survey and choose a study program	Go to the survey content page	Berhasil

Function	Testing Scenario	Expected Results	Testing Results
Fill out a survey	Complete the survey and press the "Save" button	Exit the survey content page and the survey answers are entered into the database.	Berhasil

1.2.5 Release and Feedback

The next stage, namely determining whether the system can be accepted by the client or not. Based on the tests that have been carried out, it is known that the client requested to add the download feature for the number of survey respondents and add a filter to the graph display of the survey data. Therefore, the next requirement is continued in the second iteration. After the second iteration, the system is running as intended.

4 CONCLUSIONS

The creation of a Web-Based Facility Satisfaction Survey System at the IPB Vocational School has been completed using the Codeigniter framework using the PHP programming language and agile methodology. After doing two iterations, it can be concluded that the web-based facility satisfaction survey system can be used by the education commission to manage surveys, used by respondents to fill out surveys, and can export survey results for super admins and admin units with the download feature on the page.

REFERENCES

- [1] A. Indrawati, "Pengaruh Kualitas Layanan Lembaga Pendidikan Terhadap Kepuasan Konsumen," *J. Ekon. dan Bisnis*, no. Maret, pp. 25–35, 2011.
- [2] W. Sholihah and I. Novianty, "SATISFACTORY SURVEY ANALYSIS IN IPB VOCATIONAL SCHOOL USING IMPORTANCE PERFORMANCE ANALYSIS (IPA)," in *1st International Conference on Applied Science for Energy and Food Sovereignty*, 2017, no. 1, pp. 133–143.
- [3] P. D. Sugiyono, "Populasi dan sampel," *Metod. Penelit. Kuantitatif, Kualitatif dan R&D*, vol. 291, p. 292, 2014.
- [4] H. Utama, S. Sukardi, and D. Taufik, "The Evaluation of Customer Satisfaction Survey Follow-Up in LPPOM MUI," *Indones. J. Bus. Entrep.*, vol. 6, no. 2, pp. 105–117, 2020, doi: 10.17358/ijbe.6.2.105.
- [5] G. Grunwald and B. Hempelmann, "Impacts of reputation for quality on perceptions of company responsibility and product-related dangers in times of product-recall and public complaints crises: Results from an empirical investigation," *Corp. Reput. Rev.*, vol. 13, no. 4, pp. 264–283, 2010, doi: 10.1057/crr.2010.23.
- [6] S. Sharma, D. Sarkar, and D. Gupta, "Agile Processes and Methodologies: A Conceptual Study," *Int. J. Comput. Sci. Eng.*, vol. 4, no. 5, pp. 892–898, 2012.
- [7] C. Edeki, "Scrum Software Development Methodology," *Eur. J. Math. Comput. Sci.*, vol. 2, no. 1, pp. 22–27, 2015, doi: 10.4018/978-1-4666-5888-2.ch719.
- [8] S. Atawneh, "The analysis of current state of agile software development," *J. Theor. Appl. Inf. Technol.*, vol. 97, no. 22, pp. 3197–3208, 2019.
- [9] T. Dingsøy, S. Nerur, V. Balijepally, and N. B. Moe, "A decade of agile methodologies: Towards explaining agile software development," *J. Syst. Softw.*, vol. 85, no. 6, pp. 1213–1221, 2012, doi: 10.1016/j.jss.2012.02.033.

- [10] M. Stoica, M. Mircea, and B. Ghilic-Micu, "Software Development: Agile vs. Traditional," *Inform. Econ.*, vol. 17, pp. 64–76, Dec. 2013, doi: 10.12948/issn14531305/17.4.2013.06.
- [11] P. Abrahamsson, O. Salo, J. Ronkainen, and J. Warsta, "Agile software development methods: Review and analysis," *arXiv Prepr. arXiv1709.08439*, 2017.
- [12] K. Anwar, L. D. Kurniawan, M. I. Rahman, and N. Ani, "Aplikasi Marketplace Penyewaan Lapangan Olahraga Dari Berbagai Cabang Dengan Metode Agile Development," *J. Sisfokom (Sistem Inf. dan Komputer)*, vol. 9, no. 2, pp. 264–274, 2020, doi: 10.32736/sisfokom.v9i2.905.
- [13] A. Fadhilah, "Kearifan Lokal dalam Membentuk Daya Pangan Lokal Komunitas Molamahu Pulubala Gorontalo," *Bul. Al-Turas*, vol. 19, no. 1, pp. 23–38, 2018, doi: 10.15408/bat.v19i1.3696.
- [14] M. Melinda, R. I. Borman, and E. R. Susanto, "Rancang Bangun Sistem Informasi Publik Berbasis Web (Studi Kasus : Desa Durian Kecamatan Padang Cermin Kabupaten Pesawaran)," *J. Tekno Kompak*, vol. 11, no. 1, p. 1, 2018, doi: 10.33365/jtk.v11i1.63.

ANTIBACTERIAL EFFECTIVENESS OF *EICHORNIA CRASSIPES SOLMS.* EXTRACT AGAINST SELECTED BACTERIA ISOLATES *IN VITRO*

**Lia Yulia Budiarti¹, Muhammad Bayu Wirabuana²,
Muhammad Haris Al Ghipari³, Nur Sa'adah Ramadhani⁴,
Silvia Putri Ambarini⁵, Sumiya Danurroeni⁶,
Yogi Waskito Aji⁷, Isnaini⁸**

¹*Department of Microbiology and Parasitology, Study Program of Medical Education, Medical Faculty, Lambung Mangkurat University of Banjarmasin (INDONESIA).*

²*Student of Medical Education of Medical Faculty of Lambung Mangkurat University of Banjarmasin (INDONESIA).*

³*Department of Pharmacology and Therapy of Medical Education of Medical Faculty of Lambung Mangkurat University of Banjarmasin (INDONESIA).*

lybudiarti@ulm.ac.id, yogiaji02@gmail.com

Abstract

Water hyacinth (*Eichornia crassipes Solms.*) is an aquatic weed that contains active substances, one of them is on the leaves, stem, and roots. Water hyacinth has antibacterial active substances flavonoids, phenols, alkaloids, steroids, terpenoids, tannins, and saponins. This study was aimed to analyze the optimum inhibition of ethanol extract of water hyacinth on *S.aureus*, *S.pyogenes*, *E. coli* and *S. typhi* in vitro. The study design used true experimental, post-test only with control group design, consisting of 10 concentrations of water hyacinth on the leaves, stems, roots extract (10 mg/ml, 100 mg/ml, 200 mg/ml, 300 mg/ml, 400 mg/ml, 500 mg/ml, 600 mg/ml, 700 mg/ml, 800 mg/ml, 900 mg/ml), ciprofloxacin 5 µg (positive control), and DMSO 5% (negative control). Data analyzed using One-Way ANOVA test, Duncan Post-hoc test, and Independent T-test at 95% confidence level. The results showed an increase inhibition in accordance with the increase in

concentration 700-900 mg/ml water hyacinth extract was the optimum concentration of *S.aureus* and *S.pyogenes* and 700-800 mg/ml concentration of *E. coli* and *S. typhi*. The conclusion of this study was the differences in the optimum inhibition of water hyacinth extract for *S.aureus*, *S.pyogenes*, *E. coli* and *S. typhi*.

Keywords: s extract of water hyacinth, *Escherichia coli*, *Salmonella typhi*, *Staphylococcus aureus*, *Streptococcus pyogenes*

1 INTRODUCTION

Bacteria that cause infection in humans consists of gram-positive and gram-negative bacteria. Gram-positive bacteria that become normal flora and become agents of opportunistic and nosocomial infections include *Staphylococcus aureus* (*S. aureus*) and *Streptococcus pyogenes* (*S. pyogenes*). Gram-negative bacteria that become infectious agents include *Escherichia coli* (*E. coli*) and *Salmonella typhi* (*S. typhi*) [6]

Staphylococcus aureus causes skin infections such as (acne, pyoderma, and impetigo), pneumonia, meningitis, empyema, sepsis, endocarditis and osteomyelitis. *Streptococcus pyogenes* can cause pharyngitis, rheumatic fever, glomerulonephritis, erysipelas, cellulitis, necrotizing fasciitis, and streptococcal pyoderma. The disease that can be caused by these two bacteria is impetigo [6] A global study of the population prevalence of impetigo concludes that more than about 162 million children between the ages of 2 and 5 years old have suffered from this disease and tends to occur in tropical and low-income countries such as Indonesia [12] The incidence of impetigo at Al-Islam Hospital Bandung in 2013 was 1,72 % of all skin infection patients with the most common incidence being impetigo contagious [28]

Escherichia coli causes several diseases such as urinary tract infections, diarrhea, sepsis, and meningitis. *Escherichia coli* is the main causes of acute diarrhea suffered by all ages [41]. The prevalence of diarrhea in Indonesia based on the diagnosis of health workers and symptoms in 2018 was 8% and the prevalences of diarrhea in South Borneo was 6 % [4] *Salmonella typhi* can causes

several diseases including typhoid fever, bacteremia with focal lesions, and enterocolitis [6]. The most common disease caused by *S. typhi* is typhoid fever.

The national prevalence for typhoid fever (based on diagnosis by health professionals) is 1,6 %. South Borneo is included in the province that has a prevalence of typhoid fever above the national prevalence with a percentage of 1.95% [11] One of the antibiotic used to treat infections caused by *S. aureus* and *S. pyogenes* is a macrolite group such as erythromycin, while for *E. coli* and *S. typhi* is fluoroquinolone group such as ciprofloxacin [6, 26; 37]. It has been reported that the level of erythromycin resistance to *S. aureus* is 47,2 % and *S. pyogenes* is 50 %, while the sensitivity level of ciprofloxacin to *E. coli* is 60 % and *S. typhi* is 54,34 % [7,18,25,]

Along with the times, many Indonesian people use medicinal plants as alternative medicine. One type of aquatic weed that is widely found in South Borneo is the *Eichornia crassipes* Solms. plant. *Eichornia crassipes* Solms. apparently has many benefits including to treat vaginal discharge, itching of genitals, laryngitis, ulcer/abscess, urticaria and urinary incontinence. *Eichornia crassipes* Solms. contains flavonoid, phenol, alkaloid, steroid, terpenoid, tannin, saponin, and anthraquinone. Based on several studies, *E. crassipes* Solms. extract has antibacterial activity against *S. aureus* [33, 14; 21, 20, 31; 38], *S. faecalis* [33; 14], *S. mutans* [17], *E. coli* [16; 13, 31], *S. typhi* [5; 17; 15].

Tulika's result of Tulika's research stated that there were differences in the antibacterial of the leaves, stems, and roots of *E. crassipes* Solms. The leaves have antibacterials flavonoid, alkaloid, terpenoid, steroid, tannin, saponin, and anthraquinone. The stems have antibacterials flavonoid, alkaloid, terpenoid, steroid, saponin, and anthraquinone. Meanwhile water hyacinth the root has antibacterial content in the form of flavonoid, alkaloid, tannin, and anthraquinone [42]. Until now there has been no research on differences in the optimum inhibition of *E. crassipes* Solms. extract

against *S. aureus*, *S. pyogenes*, *E. coli*, *S. typhi* and the plant part of *E. crassipes* Solms which has the greatest activity. Antibacterial activity test using the diffusion method.

2 METHODOLOGY

Materials. Leaves, stems, roots of *E. crassipes* Solms., *E. coli* ATCC 25922, *S. typhi* ATCC 13311, *S. aureus* ATCC 25923, *S. pyogenes* ATCC 19615, erythromycin 15 µg and ciprofloxacin 5 µg as positive control, DMSO 5 % as negative control, ethanol 96 % as a solvent, Muller Hinton Agar (MHA), Brain Heart Infusion (BHI), nutrient agar, sterile aquades, sterile paper disk, standard solution of Mc Farland I (3×10^8 cfu/ml), aluminium foil, NaOH, Pb Acetate 10 %, Dragendroff reagent, Meyer reagent, gelatin 1 %, FeCl₃ 3 %, benzene, chloroform, anhydrous acetic acid, concentrated H₂SO₄.

Process of Making *E. crassipes* Solms Extract. The extraction method used for this study was maceration [22] Total of 100 gram samples of leaf powder, stem, and root of *E. crassipes* Solms. were put into a maceration device, then ethanol 96 % solution was poured slowly into the maceration device [3]. Maceration process is carried out within 3 x 24 hours by stirring until distributed, every 1 x 24 hours the filtrate is filtered and the solvent is replaced with a new one. Then the extract was put into a rotatory evaporator at a temperature of 60°C until a concentrated ethanol extract was obtained, then evaporated in a waterbath [32]. The extraction results can be stored in a refrigerator at 4°C [16] Furthermore, we do phytochemical screening on the extracts. Phytochemical Screening. Flavonoid Test, Alkaline Reagent Test: 100 mg of sample is dissolved in 50 ml of the solvent, then 1 ml of sample is taken and a few drops of NaOH solution are added. It contains flavonoids if they form faded yellow after adding aqueous acid [39]. Pb Acetate Test: 100 mg sample is dissolved in 50 ml of the solvent, then 1 ml of sample is taken and 1 ml of Pb Acetate 10 % is added to the test tube and shaken. If there is a change in color of the solution to a yellowish-brown, it means that it positively contains flavonoids [40]. Alkaloid Test; Dragendroff Test: 100 mg of sample is

dissolved in 50 ml of the solvent, then 1 ml of sample is taken and 1 ml of Dragendroff reagent is added. If a red precipitate is formed, it means that it positively contains alkaloid. Mayer Test: 100 mg of sample is dissolved in 50 ml of the solvent, then 1 ml of sample is taken and 1 ml of Mayer reagent is added. If a yellow precipitate is formed, it means that it positively contains alkaloid [40]. Tannin Test, Gelatin Test: 100 mg of sample is dissolved in 50 ml of the solvent, then 2 ml of sample is taken and 2 ml of gelatin solution 1% that containing NaCl. If a white precipitate is formed, it means that it positively contains tannin [40]. Phenol Test: Iron (III) Chloride Test: 100 mg of sample is dissolved in 50 ml of the solvent, then 1 ml of sample is taken and 1 ml of $FeCl_3$ 3% is added. If a blackish-green precipitate is formed, it means that it positively contains phenol [35]. Saponin Test, Foam Method: 100 mg of sample is dissolved in 50 ml of the solvent, then 2 ml of sample is taken and shake with 2 ml of water. If the foam appears for 10 minutes, it indicates positively contains saponin [40]. Anthraquinone Test: This test is done by dissolving 2 ml of sample added with 10 ml of aquades and then filtered, the filtrate is added with 5 ml of benzene. The extract is then added with ammonia and shaken, if there is a red color, it means a positive result of anthraquinone [19]. Steroid Test, Libermann Burchard's Test: 50 mg of sample were dissolved with chloroform and then filtered. The filtrate obtained was added with acetic acid hydrate, then heated and cooled. Concentrated sulfuric acid is added to the tube wall slowly, if a brown ring is formed indicating the presence of steroids [40]. Terpenoid Test, Salkowski's Test: 50 mg of sample were dissolved with chloroform and then filtered. The filtrate obtained is added a few drops of concentrated sulfuric acid, then shaken. If the solution is gold color, it indicates positively contains triterpenoid [40].

Preparation of Bacterial Isolates. The bacterial isolates of *E. coli* ATCC 25922, *S. typhi* ATCC 13311, *S. aureus* ATCC 25923, and *S. pyogenes* ATCC 19615, used in this study were incubated for 24 hours at 37°C. Bacterial colonies were suspended into 0,5 mL liquid BHI, then incubated for 8 hours at 37°C and carried out using sterile

aquadest for bacteria in BHI, can be adjusted to the bacterial requirements of Mc Farland I or 3×10^8 CFU / mL [26] The bacterial isolates that has been standardized with Mc Farland I or equivalent to the number of bacteria 3×10^8 CFU / mL is then applied with a sterile cotton swab on Muller Hinton Agar.

Diffusion Method Antibacterial Test. *Place the paper disk soaked in the extract solution for 1 hour. Put the paper disk into an MHA that previously contained bacterial isolates. Incubated for 24 hours at 37°C. Measure the bacterial inhibition zone using the ruler caliper [27]*

3 RESULT

The data obtained were tested for normality using the *Shapiro-Wilk test*, then carried out a homogeneity test for the *Levene's test* variant. Then *one-way ANOVA* parametric analysis was performed at a 95% confidence level. And continued with *Duncan's Post-hoc test* to find out one concentration that was significantly different than the other concentrations. To find out whether or not there were average differences between the two sample groups, an *Independent T test* was performed. The results are said to be significant if the p value <0.05 [8].

The result of the phytochemical screening in this study found that the ethanol extract of *E.crassipes* Solms contains flavonoid, phenol, alkaloid, steroid, terpenoid, tannin, saponin, and anthraquinone (table 1).

Table 1. Phytochemical Screening Results of Eichornia crassipes Solms. Ethanol Extract

No	Phytochemicals	Leaf	Stem	Root	Explanation
1.	Tannin	+	+	+	White precipitate is formed
2.	Saponin	+	+	+	A little foam is formed for \pm 10 minutes
3.	Steroid	+	+	+	Greenish blue ring is formed
4.	Terpenoid	+	+	--	A gold solution is formed
5.	Flavonoid a. Alkaline Reagen b. Pb Acetate Test	+	+	+	A faded yellow is formed a yellowish-brown is formed
6.	Alkaloid a. Dragendroff Test b. Meyer Test	--	+	--	Red precipitate is formed T Yellow precipitate is formed
7.	Phenol. Iron (III) Chloride Test	+	+	+	A blackish-green precipitate is formed
8.	Anthraquinone	+	--	+	Red color is formed

The results of the average inhibition zone formed from the giving of water hyacinth (*Eichornia crassipes Solms.*) ethanol extract to *S. aureus*, *S. pyogenes*, *E. coli*, and *S. typhi* can be seen in the following figure:

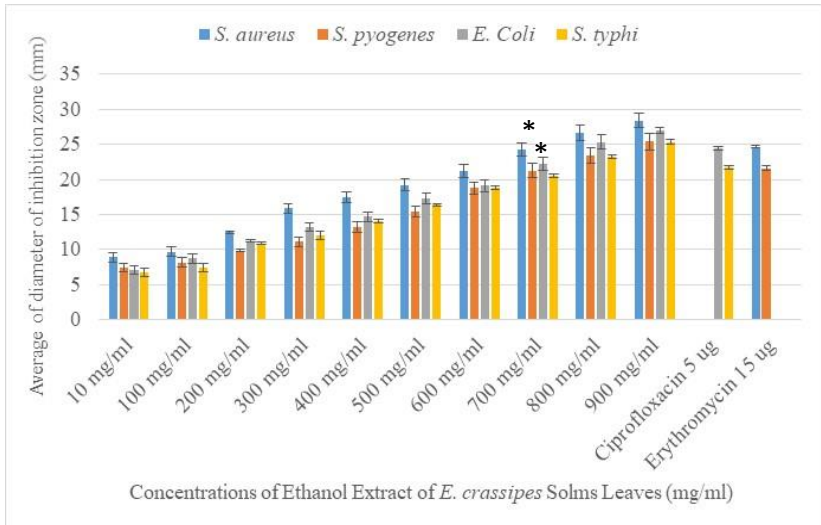

* = Concentration with significant *Independent T-test*

Figure 1. Average Inhibition Zone Diameter of Ethanol Extract of *Eichornia crassipes* Solms' Leaves against *S. aureus*, *S. pyogenes*, *E. coli*, and *S. typhi* In Vitro

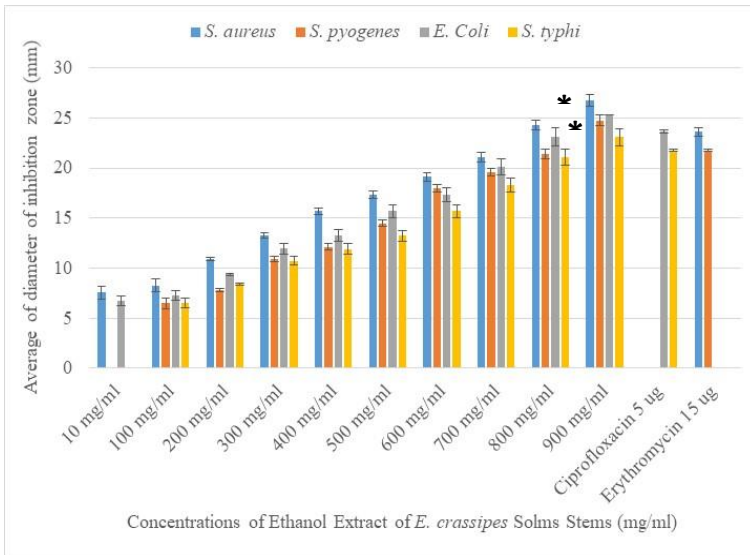

* = Concentration with significant *Independent* T-test result

Figure 2. Average Inhibition Zone Diameter of Ethanol Extract *Eichornia crassipes* Solms' Stems against *S. aureus*, *S. pyogenes*, *E. coli*, and *S. typhi* In Vitro

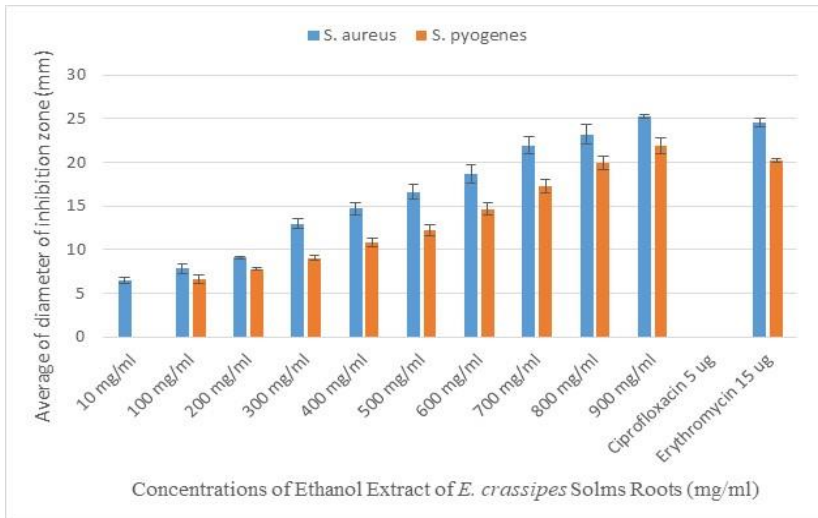

Figure 3. Average Diameter of Inhibition Zone of *Eichornia crassipes* Solms' Roots Extract Against *S. aureus* and *S. pyogenes* In Vitro

Table 2. The Smallest and largest Effect of Giving *Eichornia crassipes* Solms. Ethanol Extract against *E. coli*, *S. Typhi*, *S. aureus*, and *S. pyogenes* In Vitro

Bacteria	Part of the plant	Smallest Effect (Concentration / Inhibition Zone)	largest Effect (Concentration / Inhibition Zone)
<i>E. coli</i>	Leaf	10 mg/ml (7,03 mm)	900 mg/ml (27,01 mm)
	Stem	10 mg/ml (6,70 mm)	900 mg/ml (25,31 mm)
<i>S. typhi</i>	Leaf	10 mg/ml (6,73 mm)	900 mg/ml (25,34 mm)
	Stem	100 mg/ml (6,54 mm)	900 mg/ml (23,08 mm)
<i>S. aureus</i>	Leaf	10 mg/ml (8,93 mm)	900 mg/ml (28,38 mm)

Bacteria	Part of the plant	Smallest Effect (Concentration / Inhibition Zone)	largest Effect (Concentration / Inhibition Zone)
	Stem	10 mg/ml (7,55 mm)	900 mg/ml (26,76 mm)
	Root	10 mg/ml (6,43 mm)	900 mg/ml (25,27 mm)
<i>S. pyogenes</i>	Leaf	10 mg/ml (7,48 mm)	900 mg/ml (25,38 mm)
	Stem	100 mg/ml (6,50 mm)	900 mg/ml (24,75 mm)
	Root	100 mg/ml (6,64 mm)	900 mg/ml (21,86 mm)

Tabel 3. Optimum Inhibition of Eichornia crassipes Solms Ethanol Extract Against E. coli, S. Typhi, S. aureus, and S. pyogenes In Vitro

Bacteria	Part of the plant	Optimum Concentration (mg/ml)
<i>E. coli</i>	Leaf	800 mg/ml
	Stem	800 mg/ml
<i>S. typhi</i>	Leaf	Between 700-800 mg/ml
	Stem	800 mg/ml
<i>S. aureus</i>	Leaf	700 mg/ml
	Stem	Between 700-800 mg/ml
	Root	900 mg/ml
<i>S. pyogenes</i>	Leaf	700 mg/ml
	Stem	800 mg/ml
	Root	800 mg/ml

The reason for the optimum inhibition of *E. crassipes* Solms ethanol extract: 1) Water hyacinth leaf extract on 700 mg/ml was the optimum concentration of *S. aureus* (24.28 mm) and *S. pyogenes*

(21.28 mm); 2) Water hyacinth leaf extract on 800 mg/ml was the optimum concentration of *E. coli* (25,37 mm) and 700 mg/ml - 800 mg/ml for *S. typhi* (23,32 mm); 3) Water hyacinth root extract on 900 mg/ml was the optimum concentration of *S. aureus* (25,27 mm) and 800 mg/ml was the optimum concentration of *S. pyogenes* (19.96 mm). Water hyacinth extract 800 mg/ml is the optimum concentration of *S. aureus* (24.31 mm) and *S. pyogenes* (21.40 mm); 4) Water hyacinth stem extract on 800 mg/ml is the optimum concentration of *S. aureus* (24.31 mm) and *S. pyogenes* (21.40 mm); 5) Water hyacinth stem on 800 mg/ml the optimum concentration of *E. coli* (23,10 mm) and *S. typhi* (21,09 mm). At the same concentration of the ethanol water hyacinth extract on the inhibitory activity of *S. aureus* was greater than *S. pyogenes* and concentration the optimum inhibition of water hyacinth extract on *E. coli* was greater than *S. typhi*.

Differences in optimum inhibition of several ethanol extract treatments of *E. crassipes* Solms. against *S. aureus*, *S. pyogenes*, *E. coli*, and *S. typhi* were influenced by differences in the cell structure of the test bacteria. *Staphylococcus aureus* bacteria have exotoxins, such as enterotoxins, TSST, exfoliatin and virulence factors, namely cell walls, cell surface proteins and exoproteins; while *S. pyogenes* bacteria have virulence factors, namely protein M, hyaluronate capsules, hyaluronidase enzymes, streptokinase, dnase, toxin erythrogenic, streptolysin O, streptolysin S, pyrogenic A exotoxin and exotoxin B [23; 10]. *Escherichia coli* bacteria have two virulence factors namely *P fimbriae* and hemolysin A; while *S. typhi* has three virulence factors in the form of flagellate antigens (H antigens), somatic antigens (O antigens), and capsule antigens (K antigens). *Streptococcus pyogenes* and *S. typhi* have greater self-protection than *S. aureus* and *E. coli*, so that they are more difficult to inhibit. This is evidenced by the presence of a larger inhibitory zone against *S. aureus* and *E. coli* than *S. pyogenes* and *S. typhi* at the same concentration [36; 23, 9, 44].

The reason for the optimum inhibition of ethanol extract of the leaves of *E. crassipes* Solms. on the *S. aureus* and *S. pyogenes* were present at the same concentration (700 mg / ml) due to the phytochemical content in the ethanol extract of the leaves of *E. crassipes* Solms. can disrupt the integrity of the bacterial cell wall. In addition, these two bacteria are a class of gram-positive bacteria, so that they had wall composition the same cell wall composition in the form of thick peptidoglycan, this resulted in the growth of *S. aureus* and *S. pyogenes* could be inhibited optimally at the same concentration (700 mg / ml). The research stated that ethanol extract of binjai root (*Mangifera caesia* Jack.) could inhibit *S. aureus* more than *S. pyogenes*, due to different virulence factors and optimum inhibition of both bacteria at a concentration of 80% due to the same cell wall structure. between the two gram-positive bacteria [24].

Against *E. coli* and *S. typhi* is at the same concentration (800 mg / ml) due to both of these bacteria are gram-negative bacteria belonging to the same large family, namely *enterobacteriaceae* and have the same cell wall composition in the form of thin peptidoglycan and thick lipopolysaccharides. Mean while The mechanism of action of the phytochemical compounds in the ethanol extract of the stems of *E. crassipes* Solms. is to damage the bacterial cell wall, so that the growth of *E. coli* and *S. typhi* can be inhibited optimally at the same concentration. The research stated that ethanol extract of binjai root (*Mangifera caesia* Jack.) can inhibit *Salmonella typhi* and *Shigella dysenteriae* optimally at a concentration of 90%, due to the same cell wall structure between the two gram negative bacteria [39]

The size of the inhibition zones formed from the giving of *E. crassipes* Solms. ethanol extract the test bacteria showed antibacterial activity from the phytochemical content in the extracts, namely flavonoid, phenol, alkaloid, steroid, terpenoid, tannin, saponin, and anthraquinone. Flavonoid inhibit the enzyme topoisomerase II (DNA gyrase), which is an important enzyme in the process of replication and transcription of bacterial DNA, so that bacterial growth is disrupted. In flavonoid also phenolic compounds that can interfere

with bacterial growth. Phenol is an acidic alcohol that has the ability to denaturate proteins and damage bacterial cell membranes [1; 30].

Alkaloid interfere with the peptidoglycan constituent components of bacterial cells, so that the cell wall layers is not fully formed and causes the death of the cell. Alkaloids also have a nitrogen containing base group that will inhibit the topoisomerase enzyme that plays a role in the process of replication, transcription, and recombination of bacterial DNA [43].

Steroids interact with cell phospholipid membranes that are permeable to lipophilic compounds, causing decreased membrane integrity and cell membrane morphology to change which causes cells to become brittle and lysis [30]. Terpenoids can react with porin (transmembrane proteins) on the outer membrane of bacterial cell walls, thus forming strong polymeric bond which results in the destruction of the porin [43].

Tannins can inhibit reverse transcriptase and DNA topoisomerase enzymes so that bacterial cells cannot be formed and the toxicity of tannins can act on bacterial cell membranes [29; 2]. Saponin can cause leakage of proteins and enzymes from the bacterial cell so that the bacteria will rupture or lysis [30].

Anthraquinone works by inhibiting electron transfer in the mitochondrial respiratory chain, disrupting or damaging cell wall components namely peptidoglycan, deactivating essential enzymes, depriving bacteria of minerals and disrupting the work of the cytoplasmic membrane which will cause disruption of bacterial metabolic processes which ultimately results in bacterial death [34]. The active substances in the ethanol extract of *E. crassipes* Solms. which have a similar mechanism of action to erythromycin are flavonoid and phenol, which have a similar mechanism with ciprofloxacin are flavonoid, alkaloid and tannin. This indicates that the secondary metabolites contained in the ethanol extract of *E. crassipes* Solms. have good antibacterial activity against the selected test bacteria isolates.

4 CONCLUSION

The conclusion of this study was there are differences in optimum inhibitory activity of the water hyacinth *Eichornia crassipes* Solms extract against *Staphylococcus aureus*, *Streptococcus pyogenes* *Escherichia coli* and *Salmonella typhi* in vitro.

REFERENCES

- [1] Achwandi, M., A. Khoiriyati, and Soewito. Effectiveness of red betel leaf extract (*Piper crocatum*) against minimum inhibitory levels and minimum kill levels of *Salmonella typhi* bacteria. *Muhammadiyah Journal of Nursing* vol. 2, no. 2, pp. 1-8, 2015
- [2] Akiyama, H., K. Fujii, O. Yamasaki, T. Oono, dan K. Iwatsuki. Antibacterial action of several tannins against *Staphylococcus aureus*. *Journal of Antimicrobial Chemotherapy* vol.48, pp. 487-91. 2001.
- [3] Arifianti, L., R.D. Oktarina, dan I. Kusumawati. Pengaruh jenis pelarut pengestraksi terhadap kadar sinensetin dalam ekstrak daun *Orthosiphon stamineus* Benth. *E-Journal Planta Husada* vol 2, no.1, pp 1-4. 2014.
- [4] Balitbang Kemenkes RI. . *Riset Kesehatan Dasar; RISKESDAS*. Balitbang Kemenkes RI. Jakarta. 2018
- [5] Baral, B. dan G.S. Vaidya.. Bio-assay and Phytochemical Screening of Water Hyacinth of Nepalese Wetland. Vol. 3, no. 2, pp. 80-86, 2011
- [6] Carrol, K.C., S.A. Morse, T. Mietzner, S.J. Miller, Melnick, dan Adelberg.. *Mikrobiologi Kedokteran*. 27th ed. EGC. Jakarta. 2017
- [7] Choudhary, A., R. Gopalakrishnan, S. Nambi, Ramasubramanian, A. Ghafur, dan Thirunarayan.. Antimicrobial susceptibility of *Salmonella enterica* serovars in a tertiary care hospital in southern India. *Indian J Med Res*. 2013
- [8] Dahlan, M.S. *Statistik untuk Kedokteran dan Kesehatan*. Edisi 6 Cetakan I. Epidemiologi Indonesia. Jakarta. 2014
- [9] Darmawati, S. Keanekaragaman genetik *Salmonella typhi*. *Jurnal Kesehatan* 2(1): 1-15. 2009

- [10] David, G., M. Barer, R. Slack, dan W. Irving. *Medical Microbiology*. 18th Edition. Elsevier. Churchill Livingstone.2012
- [11] Dwiyantri, R.D., Nurlailah, dan I.K. Widiningsih.. Efektivitas air rebusan daun binahong (*Anredera cordifolia*) terhadap pertumbuhan *Salmonella typhi*. *Medical Laboratory Technology Journal* vol.1,no.1,pp. 1-6,2015
- [12] Ghazvini, P., P. Treadwell, K. Woodberry, E.Jr. Nerette, dan H. Powery. Impetigo in the pediatric population. *J Dermatolog Clin Res* vol.5,no.1,pp. 1,2017
- [13] Haggag, M.W., S.M. Abou EE, dan H.F. Abouziena.. Phytochemical analysis, antifungal, antimicrobial activities and application of *Eichhornia crassipes* against some plant pathogens. *Planta Daninha* vol.35,pp. 1-11,2017
- [14] Hamid, H.H., K.K. Ghaima, dan A.M. Najem. Photochemical, antioxidant and antibacterial activities of some extract of water hyacinth (*Eichhornia crassipes*) leaves. *International Journal of Advances in Pharmaceutical Research* vol.4,no.6, pp.1847-1851.
- [15] Hossain, J., A. Khan, dan M.A. Uddin. Antimicrobial efficacy and phytochemical analysis of three aquatic plants species in Bangladesh. *Bangladesh J Microbial* vol.35,no.1,pp 8-9,2018
- [16] Joshi, M., dan S. Kaur. *In vitro* evaluation of antimicrobial activity and phytochemical analysis of *Calotropis procera*, *Eichhornia crassipes* and *Datura innoxia* leaves. *Asian Journal of Pharmaceutical and Clinical Research* vol. 6,no.5,pp. 25-26,2013
- [17] Kumar, S., R. Kumar, A. Dwivedi, dan A.K. Pandey.. *In vitro* antioxidant, antibacterial, and cytotoxic activity and *in vivo* effect of *Syngonium podophyllum* and *Eichhornia crassipes* leaf extracts on isoniazid induced oxidative stress and hepatic markers. *BioMed Research International*. 2014
- [18] Marhamah. Resistensi bakteri gram positif terhadap antibiotik di UPTD Balai Laboratorium Kesehatan Lampung tahun 2012-2014. *Jurnal Analis Kesehatan* vol.5, no.1,pp. 467-474,2016

- [19] Marlina, S.D., V. Suryanti, dan Suyono. Skrining fitokimia dan analisis kromatografi lapis tipis komponen kimia buah labu siam (*Sechium edule* Jacq. Swartz.) dalam ekstrak etanol. *Biofarmasi* vol.3,no.1,pp. 26-31,2005
- [20] Mesfin, S. Phytochemical and antimicrobial investigation of methanolic extracts of the roots of *Eichhornia crassipes* (water hyacinth). Tesis. Bahir Dar University. Ethiopia.2018
- [21] Morales, A.G., V.V. Ordonez, A. Khusro, A.Z.M. Salem, M.E.E. Zuniga, M.Z.M. Salem, et al. Anti-staphylococcal properties of *Eichhornia crassipes*, *Pistacia vera*, and *Ziziphus amole* leaf extracts: isolates from cattle and rabbits. *Microb Pathog* vol. 113,pp. 181-189,2017
- [22] Mukhriani.. Ekstraksi, pemisahan senyawa, dan identifikasi senyawa aktif. *Jurnal Kesehatan* vol 7,no.2,pp. 361-362,2014
- [23] Murray, P.R., K.S. Rosenthal, dan M.A. Pfaller. *Medical Microbiology*. 8th Edition. Elsevier. Canada.2016
- [24] Nufus, H., L.Y. Budiarti, dan A. Biworo. Aktivitas antibakteri ekstrak akar binjai (*Mangifera caesia* Jack.) terhadap *Staphylococcus aureus* dan *Streptococcus pyogenes* *In Vitro*. *Homeostasis* vol.2,no.1,pp. 131-8,2019
- [25] Pasaribu, D. Uji kepekaan isolat klinis *Escherichia coli* terhadap antibiotika. *Skripsi*. Fakultas Farmasi Universitas Sumatera Utara. Medan.2017
- [26] Rahmasari, V. dan K. Lestari. Manajemen terapi demam tifoid: Kajian terapi farmakologis dan non farmakologis. *Jurnal Fakultas Farmasi Universitas Padjadjaran* vol.16,no.1,pp. 184-195,2018
- [27] Rifdayani, N., L.Y. Budiarti, dan A.N. Carabelly. Perbandingan efek bakterisidal ekstrak mengkudu (*Morinda citrifolia* Liin) 100% dan *Povidone Iodine* 1% terhadap *Streptococcus mutans* *In Vitro*. *Dentino Jurnal Kedokteran Gigi* vol 2 ,no.1,pp. 1-6,2014
- [28] Rizani, F.A., T.S. Djajakusumah, dan R.K. Sakinah. Angka kejadian, karakteristik dan pengobatan impetigo di RS Al-Islam Bandung. *Prosiding Penelitian Sivitas Akademika Unisba (Kesehatan)*. 1009-1016,2015

- [29] Robinson, T.. *Kandungan organik tumbuhan tinggi*. ITB Press. Bandung,2007
- [30] Sapara, TU., O. Waworuntu, dan Juliatri. Efektivitas antibakteri ekstrak daun pacar air (*Impatiens balsamina* L) terhadap pertumbuhan *Porphyromonas gingivalis*. *Jurnal Ilmiah Farmasi UNSRAT* vol.5,no.4,pp. 14-15,2016
- [31] Saraf, K.R. dan D.L. Barate. Antimicrobial activity of *Eichhornia crassipes* against MDR clinical pathogens. *International Journal of Recent Scientific Research* vol.9,no.6,pp. 27261-27262,2018
- [32] Senja, R.Y., E. Issusilaningtyas, A.K. Nugroho, dan E.P. Setyowati. Perbandingan metode ekstraksi dan variasi pelarut terhadap rendemen dan aktivitas antioksidan ekstrak kubis ungu (*Brassica oleracea* L, var. *capitate f. rubra*). *Traditional Medicine Journal* vol. 19,no.1,pp 43-44,2014
- [33] Shanab, S.M.M. dan E.A. Shalaby. Biological activities and anticorrosion efficiency of water hyacinth (*Eichhornia crassipes*). *J Med Plants Res* vol.6,no.23,pp. 3950-3962,2012
- [34] Simbolon, M.T., Y. Zalfiatri, dan F. Hamzah. Pembuatan sabun transparan dengan penambahan ekstrak batang pepaya sebagai antibakteri. *Chempublish J* ,vol.3,no.2,pp. 57–68,2018
- [35] Solihah, M.A., W.I.W. Rosli, dan A.R. Nurhanan. Phytochemicals screening and total phenolic content of Malaysian *Zea mays* hair extracts. *International Food Research Journal* vol.19,no.4,pp. 1533-1538,2012
- [36] Sumolang, S.A.C., J. Porotu'o, dan S. Soeliongan. Pola bakteri pada penderita infeksi saluran kemih di BLU RSUP Prof. dr. R. D. Kandou Manado. *Jurnal e-Biomedik (eBM)* vol.1,no.1,pp. 597-601,2013
- [37] Sumampouw, O.J. Uji sensitivitas antibiotik terhadap bakteri *Escherichia coli* penyebab diare balita di Kota Manado. *Journal of Current Pharmaceutical Sciences* vol.2,no.1,pp. 104-110,2018

- [38] Sunitha, P., S. Apparao, R.M. Sandhya, B. Sirisha, dan K. Lavanya. Research article evaluation of antibacterial, anti-inflammatory and antioxidant activities of methanolic extract of whole plant of *Eichhornia crassipes*. Vol.48, no.10, pp. 37-42, 2018
- [39] Suryani, G.E., A. Biworo, dan L.Y. Budiarti. Aktivitas antibakteri ekstrak akar binjai (*Mangifera caesia* Jack.) terhadap *Shigella dysenteriae* dan *Salmonella typhi* In Vitro. *Homeostasis* vol.2, no.1, pp. 193-202, 2019
- [40] Tiwari, P., B. Kumar, M. Kaur, G. Kaur, dan H. Kaur. Phytochemical screening and extraction: a review. *Internationale Pharmaceutica Scientia* vol. 1, no.1, pp. 98-106, 2011
- [41] Tuntun, M. Uji efektivitas ekstrak daun pepaya (*Carisa papaya* L.) terhadap pertumbuhan bakteri *Escherichia coli* dan *Staphylococcus aureus*. *Jurnal Analis Kesehatan* vol.7, no.3, pp.497-502, 2016
- [42] Tyangi, T. Phytochemical screening of active metabolites present in *Eichhornia crassipes* (Mart.) Solms and *Pistia Stratiotes* (L.): Role in ethanomedicine. *Asian Journal of Pharmaceutical Education and Research* vol.6, no.4, pp. 40-56, 2017
- [43] Wahdaningsih, S., E.K. Untari, dan Y. Fauziah. Antibakteri fraksi n-Heksana kulit *Hylocereus polyrhizus* terhadap *Staphylococcus epidermidis* dan *Propionibacterium acnes*. *Pharm Sci Res* vol.1, no.3, pp. 189-90, 2014
- [44] Wain, J., H. Debrah, Z. Afia, B. Stephen, N. Sathesh, K. Claire, B. Zulfiqar, D. Gordon, dan H. Rumina. Vi antigen expression in *salmonella enterica* serovar typhi clinical isolates from Pakistan. *Journal of Clinical Microbiology* vol.43, no.3, pp. 1158-1165, 2006

EFFECT OF CHIA SEED ADDITION AS AN ALTERNATIVE EGG SUBSTITUE TO EXPANSION VOLUME IN SPONGE CAKE

Prima Wijayanti¹, Dini Nur Hakiki²

*^{1,2} Food Technology Study Program,
Faculty of Science and Technology,
Universitas Terbuka (INDONESIA)
primawijaya66@gmail.com*

Abstract

Chia seeds have the ability to hold and absorb water up to several times their dry weight, triggering gel formation. The characteristics of chia seeds can be used as an alternative to egg substitutes in developing sponge cake. This study aimed to determine the effect of chia seeds addition as an alternative to eggs and their composition in developing sponge cake products. The research method used the ratio of eggs and chia seeds of 25%, 50%, 75%, and 100%. The calculation of the percentage of expansion volume was measured by the height of the dough before baking and after baking. The results showed that the power of sponge cake in the control was 63.5%. The percentage yield of chia seeds 25% and 50% had higher expansion volume compared to the control as 66.1% and 104.2%, respectively. Chia seeds can be a substitute in making sponge cake. The best composition of chia seeds used to substitute sponge cake products is 50%.

Keywords: Chia seed, egg, expansion volume

1. INTRODUCTION

Sponge cake is product made of wheat flour, eggs, sugar, fat, and developer cake which are then baked (Imami 2018). However, online survey conducted by *Nielsen's New Global Health and Ingredient Sentiment Survey* in 2016, illustrates the awareness and application of healthy eating among Indonesian respondents. 80% of respondents

stated that they implemented a ban on consuming certain types of food and 15% of them were due to allergies of eggs (Pratysta 2018).

Eggs in general, consist of three main parts, namely the egg shell about 11%, egg whites (albumen) about 58%, and egg yolks (yolk) about 31% (Wulandari 2017). High levels of fat and cholesterol are one of the reasons people do not consume eggs, it is known that in 100 grams of eggs there are 13 grams of fat and 550 mg of cholesterol (Rini 2015).

Grizio and Specht from The Good Food Institute said technological advances have been made by developing alternative egg substitutes, one of which is the use of chia seeds (*Salvia hispanica* L.). Chia (*Salvia hispanica* L.) is native to South America. Studies showed that chia seeds contain polysaccharides, essential fatty acids, protein, and antioxidants of the active components of polyphenols (Arumsari 2020). Chia seeds have an oil content of 25% up to 35%, even the oil extract obtained from dried chia seeds is 55.46% of the total dietary fiber, including 53.45% insoluble dietary fiber and 3.01% soluble dietary fiber (Borneo 2010).

The price of organic mexican chia seeds for 1 kg in Indonesia is 100 thousand rupiah. According to Grizio and Specht of The Good Food Institute, one tablespoon of Chia seeds soaked in three tablespoons of water for 15 minutes is equivalent to 1 egg. If one tablespoon is equivalent to 10 grams, then 1 kg of chia seeds at a price of 100 thousand rupiah is equivalent to 100 eggs. The price of eggs in Indonesia for 10 pcs is 20 thousand up to 25 thousand rupiah, so the price for 100 eggs is 200 thousand up to 250 thousand rupiah. This showed that chia seeds as a substitute for eggs are 2 times cheaper than the price of eggs.

This study aims to determine the ability of chia seeds as an alternative to egg substitutes and their composition in developing sponge cake products.

2. METHODOLOGY

The dough of sponge cake used recipes and ingredients from Lezat Academy. Mix eggs with sugar and emulsifier, then add sifted flour and vanilla flavor, then mix well. Then add melted margarine, stir until blended. The dough is put into the mould. The height of the dough was measured with a stick and then baked at 180°C for 30 minutes. After baking, let stand for 5 minutes, then measure the height of the cake again with a stick.

The methodology used the ratio of eggs and chia seeds of 25%, 50%, 75%, and 100%.

*Table.1 Formulation of Ratio and Ingredients
 of Sponge Cake's dough*

Ingredients	Ratio				
	Control	Chia 25%	Chia 50%	Chia 75%	Chia 100%
Eggs	4 butir	3 butir	2 butir	1 butir	0
Chia Seed	0	1 sdm	2 sdm	3 sdm	4 sdm
Water	0	3 sdm	6 sdm	9 sdm	12 sdm
Sugar	100 gram	100 gram	100 gram	100 gram	100 gram
Emulsifier	½ sdm	½ sdm	½ sdm	½ sdm	½ sdm
Wheat flour	115 gram	115 gram	115 gram	115 gram	115 gram
Margarine	50 gram	50 gram	50 gram	50 gram	50 gram
Vanilla Flavor	1 sdt	1 sdt	1 sdt	1 sdt	1 sdt

The calculation of the percentage of expansion volume was measured by the height of the dough before baking (A) and after baking (B) using a stick in the center of the dough (Hajrah 2019).

Percentage of expansion volume:

$$\frac{B - A}{A} \times 100\%$$

After measuring the expansion volume, a simple organoleptic test was carried out by the researcher to describe the differences texture, aroma, and taste of each chia seed ratio in the resulting sponge cake product and repeat 5 times.

3. RESULTS

Sponge cake is one of the processed food products made from basic ingredients of sugar, eggs, and flour. This study, the functions of eggs as a developer was replaced with chia seeds. The process of making sponge cake using the sponge method technique which begins with mixing eggs and sugar until fluffy and white, then added flour which is stirred evenly and finally melted margarine is added (Sari 2015). The function of eggs in cake making is aeration. Aeration is a process that forces air out through a liquid and to create more volume (Inspirasi Baking 2018). The egg consists of the yolk and the white part, simultaneously both of which function as a binder, texture builder, expansion volume and nutritional enhancer. (Sari 2015). In the process of making sponge cake, emulsifier is added as a dough stabilizer that unites liquid with fat, so that it can help aeration and make the dough texture smoother and increase cake tenderness, increase volume, and extend shelf life (Anni Faridah 2008). Mixing with sugar will produce the desired taste, color, and flavour. The next, mixing process by stirring between flour as the main source of carbohydrates and vanilla flavor powder as a flavor enhancer so that it can be mixed evenly. Then mix the melted margarine with the technique of stirring or folding until blended. This aims to minimize the risk of deflation and loss of air bubbles which results in the dough not being able to expand optimally (Pratysta 2018). Melted margarine as a source of fat that functions to moisturize so that it is expected to form a soft and fluffy cake. The addition of melted margarine at the end of the process is intended to prevent the dough from falling down due to

the heavy nature of the fat. If the dough goes down, it will cause the cake to not expand (Inspirasi Baking 2018).

The swelling power that occurs in sponge cakes starts from eggs being beaten with sugar to produce a stable foam to capture air and carbon dioxide from the developer material, causing expansion in the volume of the dough (Anni Faridah 2008). In addition, the gluten content in wheat flour also affects the level of dough development because it can make the food dough thin and elastic (Syarbini 2013). The swelling power of the sponge cake affects the shelf life of the cake, if the resulting sponge cake does not expand it will accelerate the generation of microbes because the surface is moist and dense and not hollow (Pratysta 2018).

3.1 Effect of Chia Seeds as an Alternative Eggs Subtitue

3.1.1 Expansion Volume in Sponge Cake

This study, the expansion volume in sponge cake was produced using eggs and addition of chia seeds as a developer. The level of expansion volume is the ratio of the height of the sponge cake to the height of the dough (Hapsari 2015). This table is the percentage of chia seeds as a substitute for eggs in sponge cake products:

Table 2. Result of Effect of Chia Seeds to Expansion Volume in Sponge Cake

Ratio	Jumlah Chia (sdm)	Jumlah Telur (item)	Percentage of expansion volume
Kontrol	-	4	63,5%
Chia 25%	1	3	66,1%
Chia 50%	2	2	104,2%
Chia 75%	3	1	51,2%
Chia 100%	4	-	46,1%

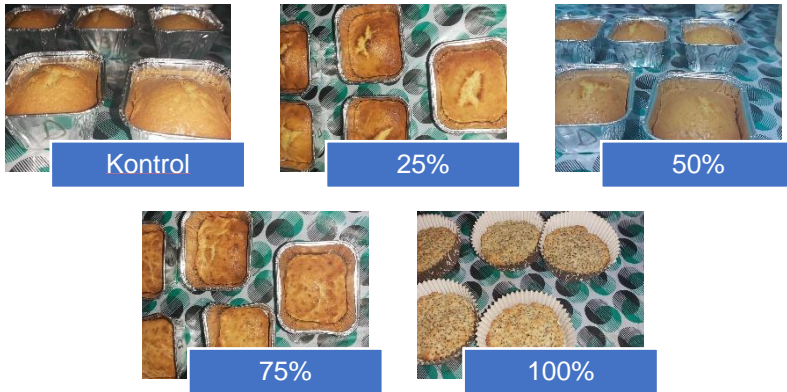

Figure 1. Result of Effect of Chia Seeds to Expansion Volume in Sponge Cake

In composition of control (100% eggs) the expansion volume produced was 63.5%, while the expansion volume which was close to the control at the 25% chia composition was 66.1%. The possibility that occurs in this composition is that the amount of water content is relatively high because it uses 3 eggs, the water is absorbed by the chia seeds to form a gel to the maximum so that the cake's expansion power also increases better than the control. However, the highest expansion volume occurred at 50% chia composition, which was 104.2%. This is likely because the composition of chia seeds and eggs is 1:1 so that the water content of the eggs is maximally absorbed by the chia seeds which are the same as the composition of the eggs. The expansion volume at 75% and 100% chia composition was not higher than the control because the eggs used wasn't to much, even at 100% composition, it did not use eggs so that the water content in the dough is relatively small and resulting in the formation of a gel by chia seeds is small also. The results of reserach showed that chia seeds cannot replace 100% of eggs in their function as a developer because the expansion volume of chia seeds depends on the composition of the water in the dough. To get maximum expansion volume, chia seeds can be substituted with a 1:1 composition with eggs as a dough developer.

Developing of the dough for sponge cake products to be successful if the foam produced from the egg whites is stable and not decrease with the addition of liquid margarine at the final stage and during the development of the resulting sponge expands perfectly with characteristics, the cake does not stick to the pan, the texture is soft when pressed, and if stabbed does not stick to the puncture (Imami 2018). Developing of dough using chia seeds to be successful if the gel formed by chia seeds is able to withstand the baking stage so as to produce a perfectly fluffy sponge (Pratysta 2018). From the data results, the developing has not been to be perfect because it is not soft when pressed.

The final process of making sponge cake is a baking process on 180°C during 30 minutes. On the process there are physico-chemical changes in the dough, these changes include increasing product temperature, especially on the surface, a decrease in water content due to heating, an increase in the highest temperature on the surface resulting in browning and hardening of the skin and a change in the dimensions of the product (Imami 2018).

3.1.2 Organoleptik of Sponge Cake

The following table is the result of organoleptic observations on the results of sponge cake.

Table 3. Result of Organoleptik of Sponge Cake

Ratio	Texture	Scent	Flavor
Control	The outer texture is a bit crunchy, but the inner texture is soft and a bit hollow	Smell of sponge cake	Sweetness
Chia 25%	The outer texture is a bit hard, the inner texture is a bit dense, not hollow	Smell the sweet smell of sponge cake	Sweetness

Ratio	Texture	Scent	Flavor
Chia 50%	The outer texture is crispy, soft and slightly hollow inside	Smell the sweet smell of sponge cake	Slightly sweeter taste
Chia 75%	The outer texture is crispy, soft and slightly dense inner texture, not hollow	Slightly sweet smell	Slightly sweeter taste
Chia 100%	The outer texture is very crunchy, the inner texture is soft, slightly melts in the mouth.	Scent is not strong, tends to go rancid	Sweeter taste

Physico-chemical changes that occur during the roasting process are influenced by the composition of chia seeds and eggs so that they produce different textures, scents and flavor (Arumsari 2020). The texture of the sponge cake product is best at the 50% chia composition because in that composition the texture of the sponge cake is crunchy on the outside, and the inside of the sponge cake has a soft and slightly hollow texture so that the cake becomes soft. The sweet scents sponge cake at ratio 25% and 50% chia composition, for ratio 75% and 100% chia composition, the sweet aroma of sponge cake decreases. That scents possibility comes from the egg foam which is stabilized by sugar, so the less the composition of the egg, the less sweet scents is produced by the cake product. However, for the sweet taste produced by sponge cake products at 100% chia composition, it is probably due to the absence of egg ingredients used so that the sweet taste of sugar dominates the sponge cake product.

Sponge cake has good quality and nutritional value if there are no microbial contaminants such as fungi that grow on the surface. Good nutritional value can be indicated by normal odor, taste, and color (SNI 012886 2000) and soft texture indicating that the gluten content is still high. From the results of the study, the best quality with a soft texture at 50% chia composition.

4. CONCLUSIONS

The research of effect of chia seeds as an alternative to eggs in sponge cake products was carried out according to the procedure, so it can be concluded that chia seeds cannot 100% replace eggs as cake developers, but can be a substitute in making sponge cake products. The best composition of chia seeds used to substitute sponge cake products is 50% of the egg composition in the recipe because in this composition, sponge cake product has a soft and hollow texture is obtained as well as a normal sweet aroma and taste in sponge cakes or 1:1 with the composition of whole eggs.

ACKNOWLEDGEMENTS

Thank you to the Universitas Terbuka as a place for me to gain knowledge, the lecturers who have supported me in writing this paper.

REFERENCES

- [1] Anni Faridah, *Patiseri Jilid 1*. Jakarta: Direktorat Pembinaan Sekolah Menengah Kejuruan, 2008.
- [2] Anonim, *Aneka Kreasi Cake & Roti*. Lezat Academy. Surabaya: PT. Pertiwi Mediasindo, 2015.
- [3] Arumsari, I. dan Sofyaningsih, M. Evaluasi Zat Tepung Chia (*Salvia hispanica L.*) dan Tepung Wijen (*Sesamum indicum L.*) sebagai Alternatif Tepung Tinggi Serat dan Protein. *Jurnal AGRIPA*. 5(1), 27-33. 2020
- [4] Borneo, R., Aguirre, A., dan Leon, A.E. *Chia (Salvia hispanica L.) Gel can be used as Egg or Oil Replacer in Cake Formulations*. *Journal of the American Dietetic Association*. 2010
- [5] Grizio, M. dan Specht, L. *Plant-based Egg Alternatives: Optimizing for Functional Properties and Applications*. The Good Food Institute
- [6] Hajrah, N.A., Hintono, A., dan Bintoro, V.P. Daya Kembang, Kadar Air, Morfologi Crumb dan Mutu Organoleptik Sponge Cake yang dibuat dengan Penambahan Enzim G-4 Amilase. *Jurnal Teknologi Pangan*. 3(2),7-12. 2019

- [7] Hapsari, P, *Tingkat Pengembangan dan Daya Terima Bolu Kukus Berbahan Dasar Tepung Singkong (Manihot esculenta Crantz) Yang Disubstitusi Tepung Daun Katuk (Sauropus androgynus)*. Universitas Muhammadiyah Surakarta, 2015.
- [8] Imami, R.H dan Sutrisno, A. *Pengaruh Proporsi Telur dan Gula serta Suhu Pengovenan*. Jurnal Pangan dan Agroindustri. 6(3), 89-99. 2018
- [9] Inspirasi Baking, *Fungsi Telur dalam Memasak Kue*. Jakarta: PT. Sriboga. 2018.
- [10] Kusnandar, F., Safari, A., dan Syamsir, E. *Perubahan Karakteristik Fisik Model Minuman Biji Chia Akibat Proses Pemanasan, Perubahan pH, Penambahan Gula dan Garam*. Jurnal Mutu Pangan. 7(1),21-29. 2020
- [11] Pratysta, A, *Penggunaan Biji Chia sebagai Pengganti Telur dalam Pembuatan Thumbprint Cookies*. Sekolah Tinggi Pariwisata NHI Bandung. 2018.
- [12] Rini, A, *Mencegah Alergi Makanan*. Jakarta: PT Elex Media Komputindo. 2015.
- [13] Sari, F, *Eksperimen Pembuatan Cake Tepung Mocaf dengan Sponge Methode dan Pound Method dan Penggunaan Gula yang Berbeda*. Universitas Negeri Semarang. 2015.
- [14] Syarbini, M Husin, *A-Z Bakery*. Solo: Metagraf. 2013.
- [15] Wulandari, R, *Manfaat Ajaib Telur*. Yogyakarta: Rapha Publishing. 2017.

DESIGNING HAND WASHER SINK FOR PRIMARY STUDENT FROM ERGONOMIC PERSPECTIVE

Tony Wiguna¹, Triarti Saraswati², Aditya Tirta Pratama³

Swiss German University (INDONESIA)

tonyw10.tw@gmail.com

Abstract

Since the shocking outbreak of Covid-19, everyone in the world has prioritized their hygiene in every activity. Everyone need to keep their hygiene to avoid from being infected by Covid-19. Washing hands properly is very important, what is more while the user is in the public toilet. Hygiene of the sink in public areas is quite concerning as there are lots of people who used it in the public. Children need to wash their hands often, what is more children used to have lots of activities every day and they need to keep their cleanliness in order not to get infected by viruses. The purpose of this research is to evaluate the existing prototype, using observation to find out the real cause of the problem. Task analysis was used to observe how primary students do the hand washing. Gap analysis was then used to detect the problem and find the possibility for improvement. Then the design improvement will be proposed. Based on observation the user still needs to bend the back while washing hand that requires new consideration in the measurement of the sink. Based on the gap analysis the new measurement was calculated using anthropometry data. The proposed design then was defined using ergonomic parameter, such as body measurement (anthropometry) and safety factors. The improved prototype has 36%-39% more efficient compare to the previous prototype.

Keywords: Covid-19, Hygiene, Observation, Task analysis, Anthropometry

1. INTRODUCTION

Since the shocking outbreak of Covid-19, everyone in the world has prioritize their hygiene in every activity that they have done. Washing hands properly is very important, what's more while using the public toilet. Hygiene of the sink in public areas is quite concerning as there are lots of people who used it in one day. Children need to wash their hands often, what's more children used to have lots of activities every day and they need to keep their cleanliness in order not to get infected by virus. If the sink is hard to reach by the children, they might be lazy to wash their hands as it needs more effort to just wash their hands. It is important to measure the height of the sink in order for the children to be able to use it properly and easily. It will also help the children's safety while washing their hands.

2. METHODOLOGY

Figure 1 shows the Process flow needed in this research. DMADV method is used to solve the problem related to the design of the product. It is required to have a continuous improvement on the product, so that user will be satisfied with the product. The objective of this method is to create a high-quality product and keep in mind the customer requirements at every phase of the method.

In define phase, it will help to determine and identify the objectives and problems occur in the research. This phase contains problem identification and literature review. Problem identification will specify the problem occur and literature review will provide theory to avoid confusion between the readers.

The second step of this methodology is to measure all the parameters needed in order to collect information and method to solve the problem. Observation of the user while using the existing prototype is needed as well as gathering anthropometry data of a student from age 7-12. Observational data is a valuable form of research that can give researchers information that goes beyond numbers and statistics. In general, observation is a systematic way to collect data by observing people in natural situations or settings.

After the parameters have been measured, ideal position of washing hands were shown. It is to have a standard of an ideal position while washing hands. The anthropometry data will then be processed to acquire the optimal height of the sink so that bending will not occur when the user is using the hands washer sink.

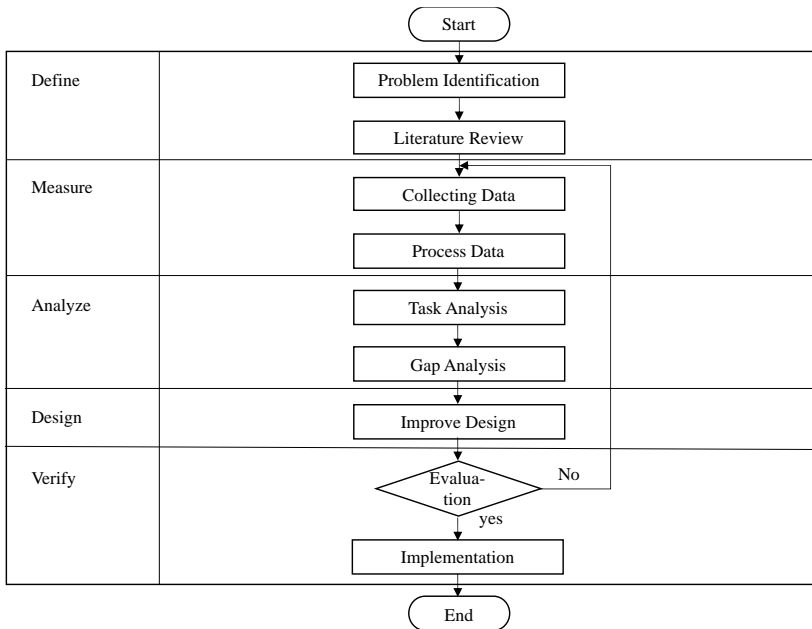

Figure 1. Process flow.

After the parameters has been defined, the process of the methodology needs to be analysed in order to have continuous improvement on the process. This phase will identify the cause of issue of the current situation to find the suitable solutions to reach the objectives of this research

At this phase, there will be task analysis and gap analysis included. Task analysis will analyse the difference between the procedure and the time needed of the user while washing hands in

regular sink and existing automated hand washer sink, while gap analysis will analyse the current situation and find out what is the action needed to improve the current situation so that desired situation can be achieved and there will be no deficiencies occurred in the hand washer sink.

Design phase includes high level design of a product and detailed specifications for the selected alternatives. Improved design will be proposed as a basis for prototyping. The specifications of the design are prioritized, and the improved design will be developed.

Verify is the final phase in the DMADV methodology. This process will validate the design of the new proposed prototype to avoid unnecessary accidents happen to the users. It will ensure that every method used in the previous phase is well and correctly implemented into the hand washer sink.

3. RESULTS

This chapter will cover all the findings and data collected during the research, which include evaluating existing prototype and improving the design of the prototype by having some analysis on it. This thesis research is conducted between February 2021 to June 2021.

3.1 Problem Identification

Due to the limitations and deficiencies occur while using the existing automated hand washer sink, the design of the existing prototype needs to be change and improve based on ergonomic approach. The height of the sink is too low to reach by the user which makes the body posture of the user is in awkward position and bending occur while the user is washing hands as the backbone is not in straight line or ideal position where musculoskeletal disorder might occur. The height of the sink needs to be adjust based on anthropometry data so that there will be no bending occur while using the sink.

The existing prototype needs more than 30 seconds for it to be available for other users to use it, which is called homing process. Homing process is the process where there will be no user allowed to use the sink for 30 seconds so that the sink can return to its zero position first. The homing process can cause a waste of time and lots of traffic for other people and primary students cannot wait that long for only using the automated hand washer sink. The algorithm needs to be change or the homing process need to be removed.

3.2 Data Collection

Qualitative and quantitative data will be shown in this phase. The data that has been collected was the body posture of the user while using the existing hand washer sink and the anthropometry data of body height and elbow height for identifying the optimal sink height.

3.2.1 Deficiency Occurs in The Prototype



Figure 2. Deficiency occurs in the prototype.

Figure 2 shows the deficiency occur in the prototype while there are users who are using the hand washer sink. It shows the are some limitations occur in the design. The height of the sink is not tall enough which makes the user bent over in order to wash her hands. The position of the sink is in the waist of the user which is too low and bending will occur while the user is using the prototype.

3.2.2 Anthropometry Data

Table 1. Anthropometry data age 7-12.

Age	Dimension	Description	5th	50th	95th
7	D1	Body height	102,67	116,14	129,61
	D2	Elbow height	58,61	70,26	81,9
8	D1	Body height	92,96	114,96	136,95
	D2	Elbow height	61,08	71,26	81,43
9	D1	Body height	112,89	122,47	132,05
	D2	Elbow height	67,92	75,46	83,01
10	D1	Body height	116,43	127,27	138,11
	D2	Elbow height	68,97	79,22	89,46
11	D1	Body height	121,25	133,31	145,36
	D2	Elbow height	68,84	82,03	95,23
12	D1	Body height	119,62	137,67	155,72
	D2	Elbow height	75,57	88,02	100,48

Table 1 shows the anthropometry data for primary students from age 7-12. The anthropometry data is filled with 2 dimensions, which is body height and elbow height. The elbow height will be measured to find out the optimal height of the sink needed while washing hands as the sink needs to be right under the elbow of the user to avoid bending while washing hands

The body height will be measured to adjust the body height and elbow height of the user. percentiles will be needed to define the 3 best optimal position of the sink. The body height will show that a user with specific amount of body height will be comfortable to use the first, second, or third optimal position of the sink. Each dimension will be calculated for the mean to achieve the optimal sink based on the elbow height.

3.3 Process Data

Process data is a phase where every data that has been collected will be measured and processed. Data processing occur when the data that has been collected can be translated into usable information that can be read or understand easily. Each step of data processing needs to be taken in order so that the raw data will not be process randomly.

Table 2. Body height age 7-12 with percentiles.

	5th percentile	50th percentile	95th percentile
Age 7	102,67	116,14	129,61
Age 8	92,96	114,96	136,95
Age 9	112,89	122,47	132,05
Age 10	116,43	127,27	138,11
Age 11	121,25	133,31	145,36
Age 12	119,62	137,67	155,72
Mean	110,97	125,30	139,63

Table 2 shows the anthropometry data of dimension of the body height. The dimension of the body height is calculated in 5th percentile, 50th percentile, and 95th percentile. This data has been processed based on the anthropometry data collected from antropometriindonesia.org and the data collected has been shown in the data collection phase.

This research is collecting and processing data from age of 7-12 as this research is focusing on primary students. The percentiles tell you whether the measurement given in the tables relates to the 'average' person, or someone who is above or below average in a certain dimension. The mean of the percentiles has been shown in the Table 4.2

Table 3. Elbow height age 7-12 with percentiles.

	5th percentile	50th percentile	95th percentile
Age 7	58,61	70,26	81,9
Age 8	61,08	71,26	81,43
Age 9	67,92	75,46	83,01
Age 10	68,97	79,22	89,46
Age 11	68,84	82,03	95,23
Age 12	75,57	88,02	100,48
Mean	66,8	77,7	88,6

Table 3 shows the elbow height with age 7-12 with percentiles. The dimension of the elbow is calculated in 5th percentile, 50th percentile, and 95th percentile. This data has been processed based on the anthropometry data collected from antropometriindonesia.org and the data collected has been shown in the data collection phase.

This research is collecting and processing data from age of 7-12 as this research his focusing on primary students. The percentiles tell you whether the measurement given in the tables relates to the 'average' person, or someone who is above or below average in a certain dimension.

Table 3. Sink height vs body height.

	Sink height (cm)	Body height (cm)
First optimal height	66,8	110,97
Second optimal height	77,7	125,30
Third optimal height	88,6	139,63

Table 4 shows the relationship between the sink height and the body height. The sink and body height were taken from the mean or average from table 2 and 3. This means that the average body height for the first optimal height of the sink is 110.97 cm, average body height for the second optimal height of the sink is 125,30 cm, and the average body height for the third optimal height of the sink is 139,63 cm. This indicate that the average body height for the user to choose which optimal height that suit best for them while washing hands.

3.4 Task Analysis

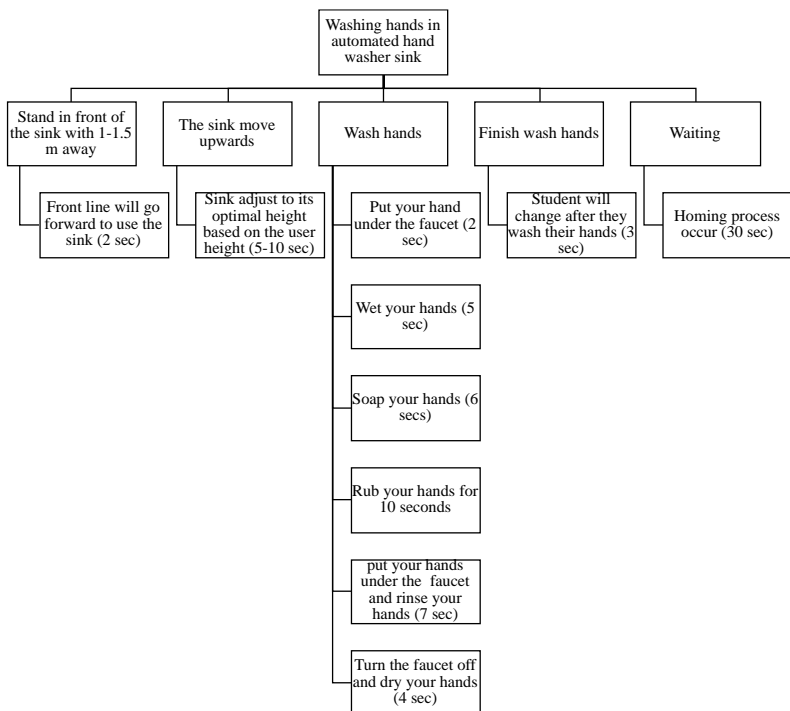

Figure 3. Task analysis of regular hand washer sink.

Figure 3 shows the task analysis of regular hand washer sink. Based on the task analysis above, it needs 74-79 seconds in total for a student to use the automated hand washer sink properly. The procedure shows that student will change after they wash their hands for 3 seconds, while the prototype needs 30 seconds to do the homing which is too long for primary students to wait. Even more, after 30 seconds of homing, students still need to wait for the sink to adjust for the user's height and it may take around 5-10 seconds. So, in total probably there will be 35-40 seconds for the sink to be ready to use.

Realistically, 35-40 seconds is too long for an automatic hand washer sink to be used as there is no way primary students can wait that long because primary students are fussy, and they will not be patient to wait for 35-40 seconds just to wash their hands. They rather not to wash their hands and just do the next activity that they should do which is not good for their hygiene. 35-40 seconds will cause lots of traffic and it is not efficient and effective to use the automatic hand washer sink.

3.5 Gap Analysis

Table 4. Gap analysis.

No.	Gap analysis		
	Desired situation	Current situation	Action plan
1	Position of the body should be straight or in ideal position	Bending occur while washing hands	Position of the sink need to be higher
a	Body should be in front of the sink	Position of the body is not right in front of the sink	Standing position need to be applied
b	Position of your palm should be right under the faucet	Position of the hands are forced right under the faucet	Height of the sink need to be adjust
c	Elbow must approximately 90-110 degree towards the faucet	Elbow not yet approximately 90-110 degree towards the faucet	Height of the sink need to be adjust under the elbow
2	Waiting time should be as short as possible	Waiting time 30 seconds	Formula in the algorithm need to be change
a	No homing process needed	30 seconds to do homing, and still need to calculate the height of the user	Formula in the algorithm need to be change

Table 4 shows the gap analysis of the existing hand washer sink. In this gap analyses, there are 2 main objectives, which is improving

the posture or position of the user, where bending still occur and improving the waiting time for the sink to be available to be used by the next user, so that the waiting time won't be too long. Every objective has their own subsections.

3.6 Improve Design

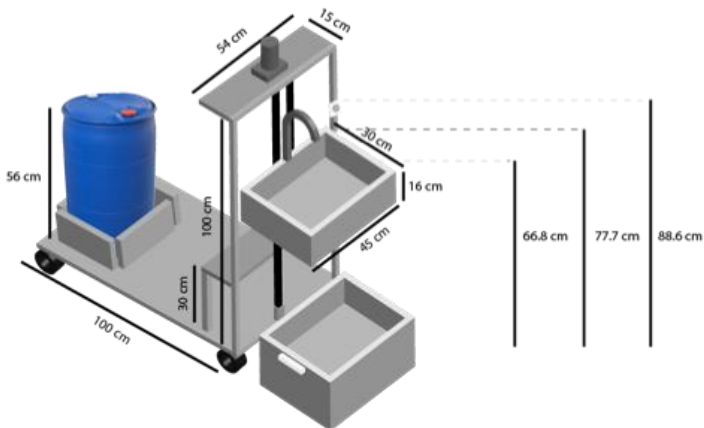

Figure 4. Design of automated hand washer sink with adjustable sink.

Figure 4 shows the new prototype design that has been improved from the existing prototype. Some adjustment has been made, some specifications has been changed, and some waste has been removed to reduce the weight of the new prototype.

The automated hand washer sink was equipped with 3 buttons with different height. The first height is 66.8 cm, the second height is 77.7 cm, and the third height is 88.6 cm which is the tallest. Those 3 buttons exist for adjusting the height of the sink and each height of the buttons has been calculated based on the height of the elbow in order for the user to have its ideal position while washing hands. By doing this, students who are tall and short enough can use the automated hand washer sink.

On the other hand, the faucet and the soap will be automatic so that the user don't need to touch the faucet and the soap if they want to use it, just put your hands under the faucet or the soap in order to use it.

3.7 Evaluation

Figure 5 shows the highest optimal sink height that is used by the highest average student in primary school. This sink has height of 88.6 cm to adjust with the height of the user that are using the hand washer sink. There is no bending occur while the user is washing their hands, it is because the height of the sink is ideal for the user. The position of the sink is almost perfect as the user do not need to stretch his hands to reach the faucet.

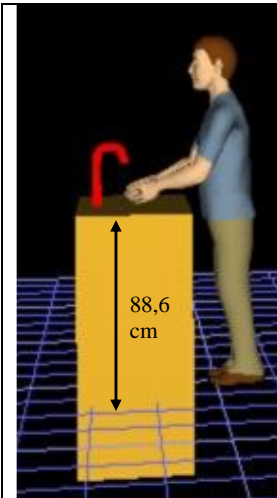

Figure 5. Sink height 1.

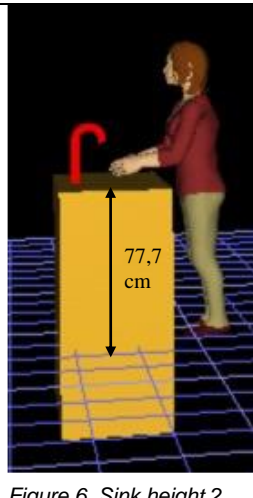

Figure 6. Sink height 2.

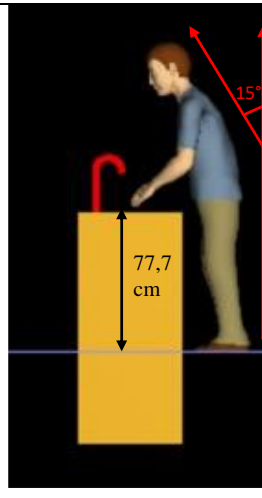

Figure 7. Bending occurs.

Figure 6 shows the second optimal sink height that is used by the medium height average student in primary school.

This sink has height of 77.7 cm to adjust with the height of the user that are using the hand washer sink. There is no bending occur while the user is washing their hands, it is because the height of the sink is ideal for the user. The position of the sink is almost perfect as the user do not need to stretch his hands to reach the faucet.

Figure 7 shows bending occur while using the automated hand washer sink. Bending occur as the user with height 139 cm uses a sink with height of 77,7 cm which is the second optimal height of the sink. Bending occur with 15° while using the sink as the user need to use the third optimal height with 88.6 cm so that bending will not occur while washing hands.

3.8 Implementation

Implementation phase is the last phase occur in the flowchart. Since the new prototype has surpass the evaluation process, now it can be implemented into action. The algorithm used in the existing automated hand washer sink has been change in order to reduce the time waste occur as it is really important to enhance the efficiency and effectiveness of the automated hand washer sink. The safety precaution has also been implemented in the new prototype to reduce unnecessary accident happens to the users who are using the automated hand washer sink. New design has also been implemented to reduce some waste that are not needed with more affordable budget.

4. CONCLUSIONS

In conclusion, the existing automated hand washer sink has been improved based on ergonomic approach as there will be no bending occur while using the new hand washer sink, because the algorithm in the height of the sink has been improved based on the elbow height of primary students. The new automated hand washer sink will remove the potential of musculoskeletal disorder to occur in early age for students as it can inhibits the growth of them. Homing process has been removed totally to avoid waste of time and to increase the

effectiveness and efficiency of the automated hand washer sink. The time frequency for using the new automated hand washer sink is more efficient and effective than the existed hand washer sink.

The deficiencies and limitations occur in the existing automated hand washer sink has been improved. The design for the sink is now ideal for the user to use it, there will be no bending occur while using the hand washer sink as the height of the sink has been measured and calculated based on antropometriindonesia.org. The homing process that is occur in the existing automated hand washer sink has been remove to remove waste of time. By removing homing process, it will enhance the efficiency and effectivity of the new automated hand washer sink.

With the new proposed automated hand washer sink, it will be more useful and reliable for the user to use it as it is based on ergonomic approach. The algorithm used in the system is also simple but effective and it will make the user to feel comfortable while using the new proposed automated hand washer sink.

The efficiency of the time frequency has been improved, from 74-79 second to use the hand washer sink to 29 seconds. This shows This shows the improvement of time efficiency of 36-39%.

ACKNOWLEDGEMENTS

First of all, I would like to thank God for his unlimited blessing towards me. As well as my parents who always give me all the supports, I need on my entire life.

Also, a huge thank you for my advisor and co-advisor who keeps on leading me throughout this project by giving me meaningful advice in surpassing all barriers in this thesis project.

I also would like to express my gratitude towards my family and siblings who always cheer me up when I feel like I hit rock bottom. Without their support this thesis project and university life will seem impossible.

Finally, I would like to thank my Swiss German University friends especially industrial engineering 2017 who always supported me who also I strive with together, time flies so fast that we have spent the last 4 years together. I wish you all a successful life in the future.

REFERENCES

- [1] hikdar, A. A. & S. N. M., 2004. Ergonomics, and occupational health and safety in the oil industry: a managers' response. s.l.:s.n.
- [2] Elmansy, R., 2015. Principles of Ergonomics: Designing with User Comfort in Mind. s.l.:s.n.
- [3] Moore, L. D. R. G. Q. J. & A. J. W., 2020. The impact of COVID-19 pandemic on hand hygiene performance in hospital. s.l.:s.n.
- [4] Spasojević Brkić, V. K. K. M. M. & B. A. D., 2015. Spasojević Brkić, V. K., Klarin, M. M., & Brkić, A. D. (2015). Ergonomic design of crane cabin interior: The path to improved safety.. s.l.:s.n.
- [5] Szidon, K. & F. E., 2009. *Task Analysis*. s.l.:s.n.
- [6] MOHANTY, P. P., 2014. Studies on Product Design using Ergonomic Considerations. s.l.:s.n.

ACCEPTANCE OF INSECT AS FOOD: A REVIEW

Mohamad Rajih Radiansyah¹, Athiefah Fauziyyah²

Universitas Terbuka, Tangerang Selatan, (INDONESIA)

ing-mohamad@ecampus.ut.ac.id

Abstract

Food production has always been a challenge in the fight for sustainability. In 2050, a predicted number of 9.8 billion people around the world equates to increased food consumption in the future. Livestock and fish consumption are important sources of protein around the world. However conventional food production of these protein sources poses a threat to the world's climate and biodiversity. With a growing human population, the need for quality food is greater than ever. Feeding future populations would need the development of alternative protein sources, such as lab-grown meat, beans, fungi and insects. Insects have a number of advantages over conventional production such as high feed-conversion efficiency, low GHG production and less environmental damage. Nonetheless, consumer acceptance remains to be the main problem of adopting insects as viable sources of protein around the world, most notably in Western countries. Eating insects is not a new thing as countries, such as Congo, Mexico and Indonesia, have dishes and snack with insects as the main ingredient. Therefore the prospect of insect's consumption acceptance in more countries is available. This review discusses the role of insects in sustainability and studies the extent of people's willingness to accept insects in their diets, as well strategies to increase them. With all their potential, it remains to be seen how insects will impact food production in the future.

Keywords: Consumption, Food Production, Insects, Sustainability

1 INTRODUCTION

As society advances, the need for suitable sustenance will increase. In 2020, the human population is estimated to be around 7.8 billion people around the world it is projected to reach 9.8 billion by 2050 (FAO, 2009). With the growth of population, the food production need will also increase. However with limited natural resources, this will challenge the food industry to keep up with increasing demand of food while offering proper nutrition to the population with suitable prices. In 2020, around 700 to 800 million people are suffering from hunger (FAO, 2021a). Food insecurity can result in malnutrition, stunted growth and risk of higher chronic illness (Hartline-Grafton, 2017). The risk of food insecurity that comes with the rapid global population growth demands for a more sustainable food production.

In 2015, The United Nations calls for 17 goals called Sustainable Development Goals (United Nations, 2015). These goals involve aspiration to solve the current problems with increasing human population such as solving hungers, unsustainable manufacturing and climate change. Sustainable development is, as defined by the UN World Commission on Environment and Development, the development that fulfill the needs of the present without sacrificing the needs of the future (United Nations, 1987). Within the agriculture and food industry, the need to become more sustainable is increasingly prevalent. Sustainable food production is defined as producing food that maximize output while minimizing loss and avoiding environmental damage (FAO, 2021b). As the industries grow, their consumption of natural resources puts pressure on the stability of the earth ecosystems. Agriculture has used around 50% of the habitable land around the world (WWF, 2020). This agriculture expansion threatens the biodiversity of the wildlife and plants on earth. The increase demand in food also has affected the land in the way of soil erosion, loss of biodiverse landscape and pollution around the world (Garcia et al., 2020). On the other hand, land use is one of the biggest indicators of a successful agriculture industry (FAO, 2017). Therefore there would need to be a balance between growth of the industry and managing the finite natural resources.

Food production also has its challenges in maintaining sustainability. Livestock farming produces substantial amount of greenhouse gasses (GHG). Products from livestock farming, such as beef, fish and chicken meat, are the source of protein for most society. According to Caro et al. (2017). there has been a significant increase of GHG attributed to livestock farming, with 59%, 89 and 461% increase caused by beef cattle, pork and chickens respectively within the period of 1961 to 2010. As it can be imagined, the increase of population will also affect the production quantities of these livestock with in turn will produce more GHG. Therefore alternatives to acquire protein have been studied by scientists to find more sustainable way of consuming protein. common alternatives such as plant-based protein that were made to mimic the taste and texture of animal meat have been around, as well as cultured meat made out of cells of living animal (Ismail et al., 2020). However, consumption of insect meat is studied as another protein source alternative to conventional livestock farming.

Edible Insect as Protein Source

Protein is an essential macronutrient for the growth and repair of the human body. It is found in different parts of the body tissues such as muscle, bone, skin and hair (Harvard T.H. Chan: School of Public Health, 2012). It is the building block of the biological function, such as enzyme and hemoglobin in blood. Protein is made out of the combination of 20 different amino acids. some of these amino acids are non-essential, meaning they can be produced by the human body itself. The rest are essential which has to be obtained from food sources. These amino acids are (non-essential) Alanine, Arginine, Asparagine, Aspartic acid, Cysteine, Glutamic acid, Glycine, Ornithine, Proline, Serine, Tyrosine, (essential) Histidine, Isoleucine, Leucine, Lysine, Methionine, Phenylalanine, Threonine, Tryptophan, and Valine. The combination of these amino acids through various interactions, such as Van der Waals, hydrophobic and hydrophilic interactions, created thousands of protein combinations that are used

in various biological functions (Belitz et al., 2009). For humans, the recommended daily protein intake is 0.8 to 2.0 g/kg bodyweight depending on their level of activity (Norton & Wilson, 2009). To achieve proper nutrition, protein can be acquired from various sources of food.

Protein can be conventionally be obtained from animal sources and plant sources. Animal protein sources include cattle (cow, pig, lamb, goat), chicken and seafood (fish, crustacean).the protein source can be in the form of their meat, milk and eggs. Plant sources include legumes, grains or vegetables high with protein such as asparagus and broccoli. Conventional protein farming has been around for centuries and its production increases following the increase of the human population. For example, the meat consumption has increased by 5 to 6 percent in the last few decades. Milk consumption has also increased by 3,4 to 3,8 percent around the same timeframe (FAO, 2021). However conventional farming has its disadvantages such as land use threatening biodiversity, use of clean water and production of GHG (Herrero et al., 2011; WWF, 2020). Therefore substituting the current protein sources with another source is wanted as one way to be more sustainable one of the way is by studying insects as a source of protein.

Entomophagy and Its Practice Around The World

The practice of insect consumption is called entomophagy which derived its name from the greek words *entomos* (insect) and *phaegim* (eating) (Gallo, 2019). Insect is considered as good substitute for normal protein source due to its protein content. The protein content ranges from 35% to 63% on a dry matter basis across different species of insects such as termites, crickets and grasshoppers (Rumpold & Schlüter, 2015). Although the bioavailability of insect protein still need to be assessed and researched, insect remains to have potential for substituting conventional protein source. other than protein, insect as a whole is a also a good source of unsaturated fatty acids and micronutrients such as calcium, iron and zinc depending on the type

of insect consumed. Insect is also easy to rear and produce. Insect farming requires less land use and resources than conventional means. Insect has a high feed to food conversion rate. Compared to conventional livestock farming, insect need six times less feed than cattle and twice less than chicken to produce the same amount of protein (Rumpold & Schlüter, 2015), insect farming is also considered to be more sustainable due to its minimal resource use such as land and water as well as its potential for waste management (Tao & Li, 2018). Entomophagy are less prevalent in the current food consumption trend. However, its practice has been done for a long time in various parts of the world.

Around the globe, insect have been consumed as part of staple food or a unique dish from the region. Insect-based dishes predominantly comes from countries in continents such as Asia, Africa and South America. Insects are processed in various ways, by steaming, frying and baking (Rumpold & Schlüter, 2015). The insects consumed mostly are insects that are local in the region. In Africa for example; mealworms are consumed in countries such as Congo, Cameroon and Republic of Africa. In Latin America, such Mexico, bees, crickets and wasps are consumed. Asian countries such as Laos, Myanmar, Thailand and Indonesia also consumes a variety of insect species like crickets and beetles (Costa-Neto, n.d.; Raheem et al., 2019). Western countries such as in North America and Europe have less instance of entomophagy but more and more, processed food products based on insects are being developed and marketed to countries in those continents (Payne et al., 2016). However, perception of entomophagy is still negative in most countries, especially ones without the culture of insect eating.

Acceptance of Insect Consumption

Consumer acceptance is an importuning when marketing and selling food products. If the consumer does not accept the product, then it will be a loss for the producer. Insect has a long way from gaining acceptance as a viable protein source as well as staple food.

Even though, insect farming has advantages over conventional farming for the environment, directing the population towards acceptance is still a challenge to be had by the insect-based food industry. Currently eating insect is seen as something abnormal and disgusting, most prominent in the western civilization (Tao & Li, 2018). Marketing and normalization play a big role in increasing acceptance of eating insects. In the younger generation, they are much more accepting in insect consumption according to survey and research although the practice is still minimal (Payne et al., 2016). In one study among Swedish consumers, the reason of eating insects were mostly for concerns for the environment, health and the novelty of trying something new and exciting (Nyberg et al., 2020).

One of the biggest hurdles in consuming insects is the feeling of disgust towards them (Wendin & Nyberg, 2021). Neophobia, which is the fear of trying new and novel things, is also a factor in rejecting insect based foods, while concerns for a more sustainable environment exists, these two factors are mainly the biggest reasons for accepting or rejecting insect as food. With that said, increasing public perception is possible. by introducing a positive eating experience,, it has been seen that the public is more willing to try eating insects. People who have consumed insects are also more willing to try again (Hartmann & Siegrist, 2017). Taste is also important for repeat consumption. A pleasurable taste will also give a positive impact and cause repeat consumption (House, 2016).

2 CONCLUSION

As the world grew, more interest is placed on developing a more sustainable system across different field and industry. The food industry has a big part in developing sustainable ways of producing foods. Being able to feed the growing human population without exploiting the remaining natural resources is a big challenge for the current and future generation. The current protein consumption is deemed to be unsustainable and limited when considering the resource the world has. Eating insects is one of the way to alleviate

the heavy load the current conventional farming has on earth. Insects is comparable and in some ways better than the usual protein source food products such as meat and dairy in that they are much produce comparable quality protein while uses much less resources. While the practice of entomophagy is seen around the globe, the current market for it is not as big. Hurdles, such as the feeling of disgust, are the bottleneck of insects being consumed as staple food. However, the acceptance of insects as food is beginning to increase as the generation changes. it remains to be seen if insects can replace conventional protein products completely. More research in the kind of insects and its safety need s to be done to suite the palate of people around the world. Moreover, marketing and positive eating experience play a big part in increasing the consumer acceptance towards entomophagy.

REFERENCES

- [1] Belitz, H.-D., Grosch, W., & Schieberle, P. (2009). *Food Chemistry*. Springer Berlin Heidelberg.
<https://doi.org/10.1007/978-3-540-69934-7>
- [2] Caro, D., Davis, S. J., Bastianoni, S., & Caldeira, K. (2017). Greenhouse Gas Emissions Due to Meat Production in the Last Fifty Years. In M. Ahmed & C. O. Stockle (Eds.), *Quantification of Climate Variability, Adaptation and Mitigation for Agricultural Sustainability* (pp. 27–37). Springer International Publishing.
https://doi.org/10.1007/978-3-319-32059-5_2
- [3] Costa-Neto, E. M. (n.d.). *Chapter 2—Insects as Food: History, Culture, and Modern Use around the World*. 32.
- [4] FAO. (2009, October 12). *How to Feed the World in 2050*. http://www.fao.org/fileadmin/templates/wsfs/docs/expert_paper/How_to_Feed_the_World_in_2050.pdf
- [5] FAO. (2017). Productivity and Efficiency Measurement in Agriculture. *Global Strategy to Improve Agricultural and Rural Statistics*. <http://www.fao.org/3/ca6428en/ca6428en.pdf>

- [6] FAO. (2021a). *Hunger and food insecurity*. <http://www.fao.org/hunger/en/>
- [7] FAO. (2021b). *Sustainable Food and Agriculture*. Food and Agriculture Organization of the United Nations. <http://www.fao.org/sustainability/en/>
- [8] FAO. (2021). *World Agriculture: Towards 2015/2030—An FAO perspective*. <https://www.fao.org/3/y4252e/y4252e05b.htm>
- [9] Gallo, M. (2019). Novel Foods: Insects - Safety Issues. In *Encyclopedia of Food Security and Sustainability* (pp. 294–299). Elsevier. <https://doi.org/10.1016/B978-0-08-100596-5.22134-3>
- [10] Garcia, S. N., Osburn, B. I., & Jay-Russell, M. T. (2020). One Health for Food Safety, Food Security, and Sustainable Food Production. *Frontiers in Sustainable Food Systems*, 4, 1. <https://doi.org/10.3389/fsufs.2020.00001>
- [11] Hartline-Grafton, H. (2017). *The Impact of Poverty, Food Insecurity and Poor Nutrition on Health and Well Being*. 14.
- [12] Hartmann, C., & Siegrist, M. (2017). Insects as food: Perception and acceptance Findings from current research. *Ernahrungs Umschau*, 64(3), 44–50. <https://doi.org/10.4455/eu.2017.010>
- [13] Harvard T.H. Chan: School of Public Health. (2012, September 18). *Protein*. The Nutrition Source. <https://www.hsph.harvard.edu/nutritionsource/what-should-you-eat/protein/>
- [14] Herrero, M., Gerber, P., Vellinga, T., Garnett, T., Leip, A., Opio, C., Westhoek, H. J., Thornton, P. K., Olesen, J., Hutchings, N., Montgomery, H., Soussana, J.-F., Steinfeld, H., & McAllister, T. A. (2011). Livestock and greenhouse gas emissions: The importance of getting the numbers right. *Animal Feed Science and Technology*, 166–167, 779–782. <https://doi.org/10.1016/j.anifeedsci.2011.04.083>
- [15] House, J. (2016). Consumer acceptance of insect-based foods in the Netherlands: Academic and commercial implications. *Appetite*, 107, 47–58. <https://doi.org/10.1016/j.appet.2016.07.023>

- [16] Ismail, I., Hwang, Y.-H., & Joo, S.-T. (2020). Meat analog as future food: A review. *Journal of Animal Science and Technology*, 62(2), 111–120. <https://doi.org/10.5187/jast.2020.62.2.111>
- [17] Norton, L. E., & Wilson, G. J. (2009). *Examinations of optimal meal protein intake and frequency for athletes*. 20(2), 4.
- [18] Nyberg, M., Olsson, V., & Wendin, K. (2020). Reasons for eating insects? Responses and reflections among Swedish consumers. *International Journal of Gastronomy and Food Science*, 22, 100268. <https://doi.org/10.1016/j.ijgfs.2020.100268>
- [19] Payne, C. L. R., Dobermann, D., Forkes, A., House, J., Josephs, J., McBride, A., Müller, A., Quilliam, R. S., & Soares, S. (2016). Insects as food and feed: European perspectives on recent research and future priorities. *Journal of Insects as Food and Feed*, 2(4), 269–276. <https://doi.org/10.3920/JIFF2016.0011>
- [20] Raheem, D., Carrascosa, C., Oluwole, O. B., Nieuwland, M., Saraiva, A., Millán, R., & Raposo, A. (2019). Traditional consumption of and rearing edible insects in Africa, Asia and Europe. *Critical Reviews in Food Science and Nutrition*, 59(14), 2169–2188. <https://doi.org/10.1080/10408398.2018.1440191>
- [21] Rumpold, B. A., & Schlüter, O. (2015). Insect-based protein sources and their potential for human consumption: Nutritional composition and processing. *Animal Frontiers*, 5(2), 5.
- [22] Tao, J., & Li, Y. O. (2018). Edible insects as a means to address global malnutrition and food insecurity issues. *Food Quality and Safety*, 2(1), 17–26. <https://doi.org/10.1093/fqsafe/fyy001>
- [23] United Nations. (1987). *Report of the World Commission on Environment and Development: Our Common Future*. <https://sustainabledevelopment.un.org/content/documents/5987our-common-future.pdf>
- [24] United Nations. (2015). *THE 17 GOALS*. UNITED NATIONS | Department of Economic and Social Affairs Sustainable Development. <https://sdgs.un.org/goals>

- [25] Wendin, K. M., & Nyberg, M. E. (2021). Factors influencing consumer perception and acceptability of insect-based foods. *Current Opinion in Food Science*, 40, 67–71. <https://doi.org/10.1016/j.cofs.2021.01.007>
- [26] WWF. (2020). *Sustainable Production*. WWF. https://www.panda.org/discover/our_focus/food_practice/sustainable_production/

THE LEVEL OF CONSUMER'S PREFERENCE TO PEPPER POWDER BASED ON THE PIPERINE COMPOUND

Muhamad Holi Widodo¹, Dini Nur Hakiki²

Program Studi Teknologi Pangan, Jurusan Pertanian,

Fakultas Sains dan Teknologi

Universitas Terbuka (INDONESIA)

holiwidodo4ut@gmail.com

Abstract

Piperine was the main component in pepper powder that provide a spicy taste. This study aimed to determine the piperine compounds and water content affect the level of consumer preference then how it's affects consumer choices in a brand of pepper powder. In This study also determined the percentage of piperine content that is acceptable for Indonesian taste. This study evaluated organoleptically by 20 untrained panelists who take hedonic and ranking test. This sample using four samples of factory-produced instant pepper powder circulating in Bandar Lampung City and one original derived from ground pepper grains. Each test sample was identified the concentration of piperine compounds on a dry basis with the standard method of SNI 0004:2013. The results showed that the piperine content of five test samples in the range 3.58% to 9.73% then water content about 6,49%-9,57%. The hedonic test showed no significant difference in the panelists' taste. From the results of the ranking test, it was concluded that piperine compounds that were generally accepted by panelists were in the range of 6-7%.

Keywords: Pepper Powder, Piperine, Piper Nigrum

1 PENDAHULUAN

Lada merupakan salah satu komoditas unggulan Lampung dan termasuk salah satu komoditas perkebunan strategis yang ingin terus dikembangkan pemerintah, berbagai macam program telah

dicanangkan pemerintah terdiri dari pendampingan teknologi, peningkatan nilai tambah, pembuatan demplot dan pembangunan kawasan berbasis korporasi. Provinsi Lampung merupakan provinsi penghasil lada ke dua setelah Provinsi Kepulauan Bangka Belitung menurut Direktorat Jenderal Perkebunan (2019) produktivitas angka tetap (ATAP) Tahun 2018, angka sementara (ASEM) Tahun 2019 dan angka estimasi (AESTI) Tahun 2020, data produksi lada Provinsi Lampung tahun 2017 sebesar 13.771 ton, tahun 2018 sebesar 14.450 ton, tahun 2019 sebesar 14.436 ton, dan tahun 2020 sebesar 14.415 ton. Saat ini komoditas lada hasil perkebunan Provinsi Lampung masih diekspor/diperjualbelikan dalam bentuk lada butir, dan belum ditemukan lada bubuk instan asli produksi Provinsi Lampung. Tumbuhnya industri makanan dan minuman instan dan juga berubahnya gaya hidup di masyarakat, konsumsi bumbu/rempah tidak lagi didominasi dalam bentuk bumbu/rempah segar melainkan sudah ada sebagian masyarakat yang menggunakan bumbu/rempah kering instan dengan alasan lebih praktis. Peluang ini yang harus dimanfaatkan masyarakat Lampung sebagai Provinsi penghasil komoditas lada untuk memberdayakan masyarakat dan meningkatkan taraf ekonomi masyarakat dengan menginisiasi dan membina home industri lada bubuk instan untuk mengembalikan lagi kejayaan “Lada Lampung”.

Lada bubuk kering instan berasal dari buah lada yang mengalami beberapa tahapan proses pengolahan seperti halnya pengayakan, perendaman, pengupasan dan pencucian, pengeringan, pembubukan kemudian dilakukan pengemasan agar lebih menarik. Pengayakan untuk memisahkan biji buah lada yang kecil, tidak matang dan lada menir, pengayakan dapat dilakukan menggunakan mesin atau secara manual, dengan menggunakan pengayak, dimana buah lada dapat melewati lubang pengayak kemudian dipisahkan untuk dikeringkan. Perendaman, dapat dilakukan dalam karung atau keranjang, dalam air yang mengalir atau kolam perendaman dan harus terendam sepenuhnya. Pengupasan dan pencucian dapat dilakukan didalam air untuk mencegah perubahan warna sesudah pengupasan dan untuk menghilangkan sisa-sisa kulit, Pengeringan bertujuan untuk

mengurangi kadar air yang dapat dilakukan dengan cara di jemur dibawah sinar matahari di atas para-para untuk mendapatkan warna putih kekuningan, pembubukan lada yang telah kering kemudian digiling halus dengan ukuran sekitar 50-60 mesh, kemudian bubuk lada kering dikemas dalam kemasan yang menarik.

Beberapa merk lada bubuk mencantumkan logo kemurnian lada (100% lada murni) hal ini dikarenakan *preferensi* masyarakat terhadap produk lada bubuk yang akan di konsumsi berasal dari lada asli tanpa bahan pengisi ataupun tambahan lainnya yang berfungsi memperbanyak volume/isi lada. Menurut (Dinno Baskoro, 2015) Kualitas lada yang baik adalah lada yang memiliki aroma khas, memberikan rasa pedas, berwarna krem pekat.

Penelitian ini bertujuan untuk mengetahui tingkat *preferensi* masyarakat terhadap lada bubuk kering apakah dipengaruhi dengan rasa pedas dan berapa persen kandungan yang umum dapat diterima masyarakat, sehingga dikemudian hari dapat dijadikan sebagai referensi dalam mengembangkan produk lada bubuk dan faktor-faktor yang lebih mempengaruhi pilihan konsumen lada bubuk.

2 METODE PENELITIAN

Metode penelitian yang dilakukan adalah dengan cara melakukan uji hedonik/tingkat kesukaan masyarakat melalui pencicipan/uji cita rasa yang di lakukan secara langsung terhadap larutan kaldu-lada bubuk dengan variasi sebanyak 4 merk dan 1 lada bubuk giling dengan konsentrasi lada bubuk 0,1% dan bumbu kaldu instant dengan konsentrasi 0,1% sebagai *carier*.

Uji ranking di lakukan setelah panelis menyelesaikan uji hedonik, dan di instrusikan untuk mencicip kembali semua contoh uji dan mengurutkan dari contoh uji yang paling di sukai hingga contoh uji yang paling tidak di sukai. Sebanyak 20 orang panelis tidak terlatih dilibatkan untuk memberikan penilaian pada borang yang telah disediakan. Setiap merk lada bubuk yang diujikan kepada panelis telah di uji kandungan nya berdasarkan standard pengujian SNI 0004-2013 (Lada Putih) dan uji kadar air berdasarkan standard pengujian SNI 01-2891-1992 (Cara Uji makanan dan minuman).

2.1 Alat Dan Bahan Penelitian

2.1.1 Alat Yang Di Gunakan:

Neraca analitik, spektrofotometer ultra violet, oven, labu didih kapasitas 100 ml, labu takar (kapasitas 100 ml, 50 ml dan 25 ml), heating mantel, pendingin, pipet volume 5 ml, aluminium foil, cawan, dan boring penilaian/lembar kerja.

2.1.2 Bahan yang di gunakan:

Ethanol 96%, empat merk Lada bubuk kering/instan yang beredar di Provinsi Lampung, lada bubuk giling halus dan satu kaldu instan rasa sapi,

2.2 Tahapan Penelitian:

2.2.1 Menguji Piperin Sesuai Metode SNI 004-2013 (Lada Putih)

Bungkus terlebih dahulu alat-alat yang akan digunakan dengan aluminium foil atau kertas timah, timbang contoh seberat 0.5 gram dengan ketelitian 0.01 gram ke dalam labu didih dan ditambahkan 50 ml etanol dan beberapa butir batu didih, pasanglah alat sedemikian rupa dan panaskan selama 3 jam, kemudian dinginkan dan saring ke dalam labu takar 100 tepatkan volume dalam labu takar sampai tanda garis dengan etanol (larutan A). Pipet 5 ml larutan A, pindahkan ke dalam labu takar 50 ml dan encerkan sampai tanda garis dengan etanol (larutan B), Pipet 5 ml larutan B, pindahkan ke dalam labu takar 25 ml dan encerkan sampai tanda garis dengan etanol (larutan C), ukurlah absorbant larutan C dengan spektrofotometer pada panjang gelombang 343 nm dengan menggunakan etanol sebagai blanko.

Cara menyatakan hasil

Kadar dinyatakan sebagai persentase bobot berdasarkan contoh bobot kering.

$$\text{Kd. Piperin} = (A/1238) \times (50/25) \times (25/5) \times (100/M) \times (100/100-KA)$$

Keterangan:

M : Bobot contoh uji dinyatakan dalam gram

K A : Kadar air dari contoh uji.

A : Absorbant larutan contoh

2.2.2 *Menguji Kadar Air sesuai Metode SNI 01-2891-1992 (Cara Uji makanan dan minuman)*

Menimbang dengan seksama 1-2 g cuplikan pada sebuah botol timbang bertutup yang sudah diketahui bobotnya, keringkan pada oven suhu 105°C selama 3 jam, dinginkan dalam eksikator, timbang hingga bobot tetap.

Cara menyatakan hasil :

$$\text{Kd. Air} = (w1 / w0) \times 100\%$$

Keterangan:

w1 = Bobot cuplikan setelah di keringkan dalam gram

w0 = Bobot cuplikan sebelum di keringkan dalam gram

M0 = Bobot Cawan Kosong

2.2.3 *Uji Sensori / Organoleptik*

Membuat larutan kaldu, Masing masing merk lada bubuk di timbang sebanyak 0,2 gram, setiap merk lada bubuk yang telah ditimbang ditambahkan dengan kaldu instan sebanyak 0,2 gram, lada bubuk dan kaldu instan yang telah ditimbang dilarutkan dalam air minum mendidih sebanyak 200 ml sehingga menjadi larutan yang homogen. Cara Uji Hedonik dan Uji Ranking mengacu kepada pustaka Universitas Terbuka (Anis K, Armein, 2021, *Praktikum Evaluasi Sensori*, Tangerang Selatan, Universitas Terbuka). Masing masing merk larutan yang telah homogen dibagi menjadi *cup-cup* kecil hingga 20 *cup* di lengkapi dengan air mineral sebagai penetral dan tissue. Sebanyak 20 orang panelis diberikan instruksi singkat cara melakukan uji sensori dan disediakan air mineral sebagai penetral, panelis mengisi borang penilaian yang telah disediakan.

Aspek yang di nilai dalam mutu hedonik

Aspek yang di nilai adalah tingkat kesukaan konsumen terhadap rasa pedas masing masing larutan lada bubuk dengan memberikan respon dalam 7 tingkatan yaitu:

Table 1. Tingkat Kesukaan

Tingkat kesukaan	Kode Contoh Uji				
	A	B	C	D	E
Sangat Suka					
Suka					
Agak Suka					
Netral					
Agak tidak suka					
Tidak suka					
Sangat Tidak Suka					

Aspek yang di nilai dalam mutu ranking

Aspek yang di nilai adalah tingkat kesukaan konsumen terhadap rasa pedas masing masing larutan lada bubuk dengan memberikan no urut 1 sampai dengan 5 dengan angka 1 sebagai ranking 1 (paling di sukai):

Tabel 2. Tabel Uji Ranking

Kode contoh uji	Ranking
A	
B	
C	
D	
E	

3 HASIL DAN PEMBAHASAN

3.1 Hasil Uji Kadar Peperin dan Kadar Air

Dari hasil pengujian yang di lakukan di dapatkan hasil pengujian kadar peperin dan kadar air sebagai berikut:

Tabel 3. Hasil uji kadar air dan piperin

Kode Contoh	Kadar Air (%)*	Kadar Piperin (%)
A	6,91	6,89
B	8,55	6,12
C	9,57	7,12
D	11,62	9,73
E	6,49	3,58

Kadar air adalah banyaknya air yang terkandung dalam suatu bahan dan dinyatakan dalam bentuk persen Kadar air selain digunakan dalam perhitungan basis kering kadar lada bubuk, juga dapat dijadikan referensi kadar air lada bubuk instan yang diproduksi oleh pabrikan yaitu berkisar 6,49% sampai dengan 9,57%. Kadar air dalam bahan pangan mempengaruhi umur atau daya simpan produk. Kadar air yang terlalu tinggi dapat menyebabkan terjadinya gumpalan-gumpalan pada bubuk (lembab) dan diikuti penurunan mutu lada bubuk. Nilai kadar air dalam suatu produk bahan pangan terutama pada produk kering, kadar airnya akan terus mengalami peningkatan hingga mencapai keseimbangan dengan kelembaban udara (RH) di lingkungan sekitar (Kilcast dan Subramaniam, 2000). Oleh karena itu kemasan berperan penting dalam mempertahankan mutu produk bahan pangan.

Kadar Piperin adalah komponen utama dalam buah lada, kadarnya dalam buah lada sangat di pengaruhi oleh varietas, lahan tempat tumbuh, kondisi agroklimat, dan umur panen. Kadar Piperin sebagai senyawa khas dalam lada tidak ditentukan dalam syarat mutu ataupun rekomendasi dalam SNI 0004: 2013, kadar Piperin dalam contoh uji memiliki rentang antara 3,58 % sampai dengan 9,73%. dengan kadar 9,73% adalah lada hitam *light berries* bubuk kering yang

didapatkan dari menggiling dan mengayak lada hitam *light berries* untuk mendapatkan kadar Piperin yang tinggi untuk memperluas rentang kadar dari contoh uji.

3.2 Hasil Uji Hedonik / Kesukaan

Dari hasil pengujian panelis di dapatkan hasil sebagai berikut:

Tabel 4. Hasil Uji Hedonik

Sample /Contoh Uji	Penilaian Pedas
A	3,65 ^a
B	4,70 ^a
C	4,00 ^a
D	4,15 ^a
E	3,00 ^a

Dari hasil yang di dapatkan dengan melibatkan 20 orang panelis tidak terlatih, yang terdiri dari ibu rumah tangga, karyawan, karyawan di dapatkan hasil pengolahan uji hedonik bahwa dari sampel yang di uji sebanyak 5 sampel uji lada bubuk, tidak ditemukan perbedaan yang nyata dalam hal kesukaan konsumen, hal ini didasarkan pada hasil nilai F Hitung yang lebih kecil dari pada F-Table pada rentang kepercayaan 95% dan 99%. Data ini menunjukkan bahwa variasi kadar piperin dalam lada tidak banyak berpengaruh terhadap kesukaan panelis. Panelis tidak menjatuhkan pilihan semata-mata pada contoh uji yang paling pedas atau paling tidak pedas, akan tetapi juga mempertimbangkan aroma dan juga *after taste* (rasa pahit) setelah mencicipi contoh uji.

Uji Hedonik yang di lakukan pada penelitian ini termasuk salah satu uji yang menggantungkan pada sifat indera pengecap dan penciuman yang bersifat subyektif dan persepsi masing-masing panelis. Cita rasa merupakan suatu cara pemilihan makanan yang harus dibedakan dari rasa (taste) makanan tersebut. Cita rasa merupakan atribut makanan yang meliputi penampakan, bau, rasa,

tekstur, dan suhu. (Drummond KE & Brefere LM, 2010). Persepsi bersifat subyektif karena persepsi setiap individu terhadap suatu obyek akan berbeda satu sama lain sedangkan sifat hedonik adalah sifat kesukaan atau kepuasan setelah membandingkan antara yang didapatkan dengan yang diharapkan.

Panelis yang berkontribusi dalam uji hedonik ini di kondisikan untuk tidak mengetahui merk atau jenis kemasan, juga di sajikan dengan carrier kaldu yang sudah berupa “sup” sehingga panelis tidak dapat melihat warna dan bentuk asli lada bubuk hal ini untuk mengurangi pengaruh hedonik atas sifat fisik lada bubuk dan hedonik kemasan/merk tertentu untuk mengurangi pengaruh promosi atas produk merk tertentu.

3.3 Hasil Uji Ranking

Dari hasil pengujian panelis di dapatkan hasil sebagai berikut:

Tabel 5. Hasil Uji Ranking

Ranking	Kode Lada Bubuk	Kd. Piperin (%)
1	B	6,12
2	D	9,73
3	A; C	6,89 ; 7,12
4	E	3,58

Dari uji organoleptik yang kedua yaitu uji ranking kadar piperin dalam contoh uji semua contoh uji dinilai sama oleh panelis dalam hal rasa pedas walaupun memiliki kadar Piperin yang berbeda-beda, hal ini dikarenakan adanya faktor keanekaragaman suka atau tidak suka rasa pedas diantara panelis yang turut mempengaruhi kesimpulan akhir. Berdasarkan ranking yang di dapatkan urutan pertama adalah lada bubuk B (kadar piperin 6,12%), urutan kedua adalah lada bubuk yang berkadar piperin tertinggi D (kadar piperin 9,73%) dan panelis menempatkan urutan ke-tiga pada dua contoh lada bubuk A (kadar piperin 6,89%) dan C (kadar piperin 7,12%) dan urutan terakhir di berikan kepada lada bubuk E (kadar Piperin (3,58%) atau terendah.

Uji rangking dapat digunakan untuk mengurutkan serangkaian dua sampel atau lebih sesuai intensitas mutu dan kesukaan konsumen dan dalam rangka memilih yang terbaik dan menghilangkan yang terjelek (Amerine *et al.*, 1965). Penampakan produk merupakan atribut yang paling penting pada suatu produk, dalam memilih sebuah produk konsumen akan mempertimbangkan kenampakan dari produk tersebut terlebih dahulu dan mengesampingkan atribut sensori lainnya. Hal tersebut dikarenakan penampakan dari suatu produk yang baik cenderung akan dianggap memiliki rasa yang enak dan memiliki kualitas yang tinggi. Karakteristik dari kenampakan umum produk meliputi warna, ukuran, bentuk, tekstur permukaan, tingkat kemurnian dan karbonasi produk (Meilgard *et al.*, 2006). Untuk itu pengkodean dan mengurangi/menghilangkan atribut-atribut lain selain atribut yang di uji sama pentingnya dengan pengujian atribut yang di kehendaki.

4 KESIMPULAN DAN SARAN

Kadar Piperin dalam lada, adalah komponen utama dalam buah lada, keberadaan senyawa ini memberikan cita rasa pedas dan sedikit kesan/*after taste* pahit jika kandungannya terlalu tinggi, pada rentang kadar 3,58% hingga 9,73% tidak di temukan perbedaan yang nyata dalam hal rasa pedas sehingga dapat disimpulkan bahwa kandungan Piperin 6-7% merupakan kandungan yang cukup diterima oleh konsumen lada bubuk berdasarkan skor ranking. Untuk meningkatkan konsentrasi Piperin di dalam lada bubuk bisa di dapatkan dengan cara melakukan *mixing* / pencampuran antara lada yang memiliki kadar Piperin tinggi dengan lada yang memiliki kadar Piperin lebih rendah. Tingkat kesukaan konsumen selain rasa, aroma, *after taste* juga dipengaruhi oleh kecenderungan pada merk tertentu dikarenakan ketersediaannya yang merata di berbagai toko dan warung atau tingkat *availability* lada bubuk di pasaran.

UCAPAN TERIMA KASIH

Terima kasih kepada Ibu Dini Nur Hakiki, S.TP, M.Si., selaku dosen pengajar yang telah membimbing, mengarahkan dan mendukung hingga terselesaikannya karya ilmiah ini.

DAFTAR PUSTAKA

- [1] Anis K, Armein S., A., *Praktikum Evaluasi Sensori*, Tangerang: Universitas Terbuka, 2021.
- [2] Badan Standardisasi Nasional, *Lada Putih*, Jakarta: Badan Standardisasi Nasional, 2013.
- [3] Badan Standardisasi Nasional, *Cara Uji Makanan dan Minuman*, Jakarta: Badan Standardisasi Nasional, 1992
- [4] Eldha, S., dkk, Kadar Air, Piperin Dan Minyak Atsiri Lada Produk UKM Samboja, UKM Bontang Dan Di Pasaran Samarinda, Samarinda : Balai Riset dan Standardisasi Industri Samarinda, 2020.
- [5] Institut Pertanian Bogor, *Menuju Agribisnis Indonesia Yang berdaya Saing*, Bogor : Institut Pertanian Bogor, 2017.
- [6] Kemala, S., *Strategi Pengembangan Sistem Agribisnis Lada Untuk Meningkatkan Pendapatan Petani*, Bogor: Pusat Penelitian dan Pengembangan Perkebunan, 2015.
- [7] Nurliani, B., dkk, *Observasi Hasil dan Mutu Lada Lokal di Dua Agroekologi*, Bogor: Balai Penelitian Tanaman Industri dan Penyegar, 2013.
- [8] Ramanda, E., dkk, *Analisis Daya Saing Dan Mutu Kopi Di Kecamatan Sumberjaya Kabupaten Lampung Barat*, Bandar Lampung: Universitas Lampung, 2016.
- [9] Ratna, WA., dkk, *Karakteristik Mutu Lada Hitam dan Lada Putih dari Beberapa Kabupaten Sentra Lada di Lampung*, Lampung: Balai Pengkajian Teknologi Pertanian (BPTP) Lampung, 2020.

- [10] Sampepana, E., dkk, *Kadar Air, Dan Minyak Atsiri Lada Produk Ukm Samboja, Ukm Bontang Dan Di Pasaran Samarinda*, Samarinda: Balai Riset dan Standardisasi Industri Samarinda, 2020.
- [11] Syafril, K, *Strategi Pengembangan Sistem Agribisnis Lada Untuk Meningkatkan Pendapatan Petani*, Bogor: Pusat Penelitian dan Pengembangan Perkebunan, 2006.
- [12] Wagiono, *Menguji Pembedaan Secara Organoleptik*, Jakarta: Direktorat Jenderal Pendidikan Dasar dan Menengah Departemen Pendidikan Nasional, 2003.

FISHERIES MANAGEMENT FOR SOCIETY 5.0 IN INDONESIA

Ernik Yuliana

*Department of Agriculture, Faculty of Science and Technology,
Universitas Terbuka, (INDONESIA)*

*Jl. Cabe Raya Pondok Cabe, Pamulang, Tangerang Selatan
ernik@ecampus.ut.ac.id*

Abstract

Indonesia has a very large fisheries potential with a total of 1,193 species, which is very beneficial for the Indonesian people. The potential consists of the potential for marine fisheries and inland fisheries. Related to this potential, there are several issues in fisheries management in Indonesia, including overfishing and data availability. Reflecting on some issues happening in the fisheries management in Indonesia, there needs decent solutions that can solve the problems. Industrial Revolution 4.0 and Society 5.0 can give direct impact to the fisheries sector. Industrial revolution which progresses rapidly demands adaptation in fisheries. In order to avoid overfishing, the fisheries management also needs an advanced data system. Due to so many fish catching results in Indonesia and high diversity of fish species, it has caused the fisheries data management to require big data. Human resources are an important thing that needs to be prepared to face the Industrial Revolution 4.0 and Society 5.0. The change of activity into digital culture is not easy. Education and training need to be arranged for the human resources preparation, either from the fisher's, government's, students', and stakeholders' circle.

Keywords: fisheries mangement, Indsutrial Revolution 4.0, overfishing, Society 5.0.

1. The Potency of Indonesian Fisheries

Around 62% of the area in Indonesia is occupied by the water area, with a 5.8 million km² of sea area which is potentially managed. With such an extensive area, Indonesia has a high potency of fisheries and a variety of fishes. The potency of fisheries in Indonesia is among the largest ones in the world, either for its capture fisheries or aquaculture, with maximum sustainable yield (MSY) of 67 million ton per year (DPP, 2017). Fishbase stated, there was 1.193 species of fish in Indonesia (Froese & Pauly 2013), which was divided into seawater fish and freshwater fish. In order to minimise the species extinction, these varieties have to be conserved, because some of the freshwater fish species in Indonesia have become extinct (Syafei, 2017). The potency of fisheries and variety of fish has brought economic benefit and environment service, especially for the coastal community, and Indonesian people in general.

If compared to the production of global fisheries (Figure 1), the amount of capture fisheries is higher than the aquaculture fisheries, therefore the production of aquaculture fisheries in Indonesia is bigger (67%) than the capture fisheries (33%) (Figure 2). This is a quite pleasing fact because the production of aquaculture fisheries has been improved further and become the main expectation for the fisheries production in Indonesia. However, on the other side, we can see that the production of capture fisheries in Indonesia is not yet optimised. With extensive sea area in Indonesia, the production of capture fisheries could have been better. There are a few things which cause this issue, one of them is the quality of Indonesia's fishing boats which are less good than the foreign fishing boats which oftentimes caught up catching fishes in Indonesian territorial water area (Hendriyana, 2021).

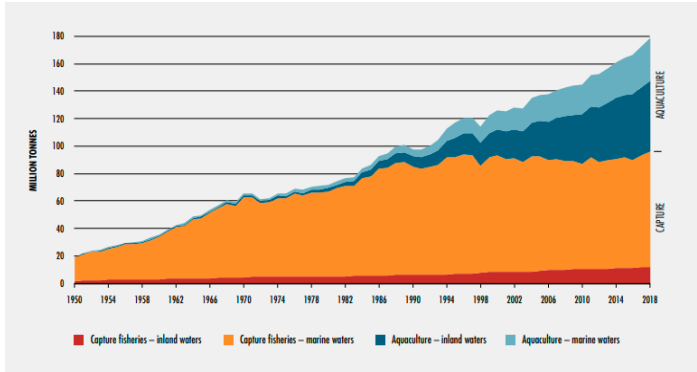

Figure 1. Comparison between capture fishery and aquaculture fishery in the world (FAO, 2020)

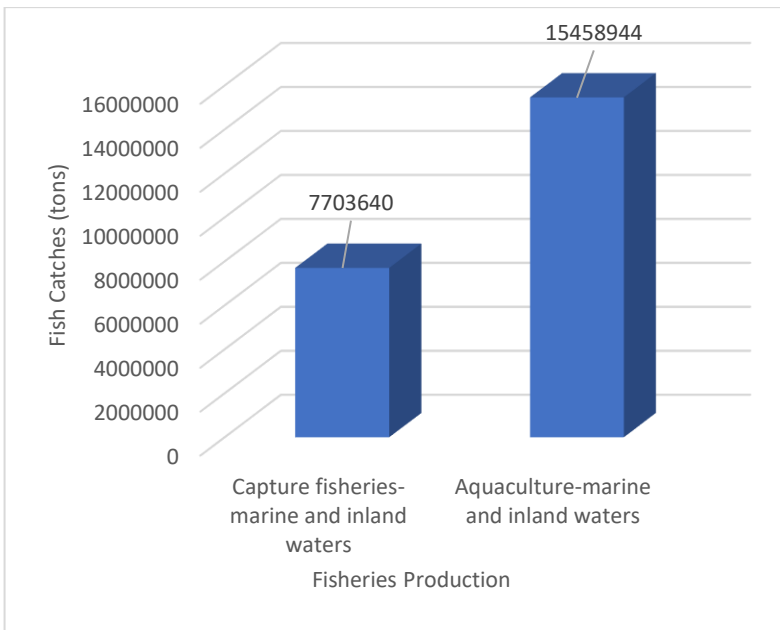

Figure 2. Comparison between capture fishery and aquaculture fishery in Indonesia
(Source: Statistical data of capture fishery, KKP, 2021)

2. Issues of Fisheries Management in Indonesia

a. Overfishing

According to FAO (2020), the capture fisheries result in the world has expanded from 89.6 million tons (in 2016) to 93.1 million tons (in 2017), and to 96.4 million tons (in 2018). Majority of the top 10 captured fish species, which covers a total of 30% of the total production of world marine capture fisheries, have been fully exploited (FAO, 2016). As well as for the fish resources in Indonesia, there is a possible threat of overfishing on certain species and areas. Based on the research by Yuliana et al. (2016) on reef fishes in Karimunjawa National Park, there were two of four reef fishes which were over-exploited (Table 1), they are *Caesio caerulea* dan *Plectropomus oligacanthus*, with exploitation rate value (E) of 0.55 and 0.77. Based on the criteria from Pauly (1984), a rational and sustainable exploitation rate value (E) in water area comes at $E < 0.5$ or maximum of $E = 0.5$.

Table 1. The Exploitation Rate of Reef Fish
 in Karimunjawa National Park

Species	Famili	Mortality			E
		Z (/year ¹)	M (/year ¹)	F (/year ¹)	
<i>Caesio cuning</i>	Caesionidae	1.67	0.99	0.68	0.41
<i>Caesio caerulea</i>	Caesionidae	4.49	2.04	2.45	0.55
<i>Plectropomus oligacanthus</i>	Serranidae	3.03	0.70	2.33	0.77
<i>Parupeneus barberinus</i>	Mullidae	1.19	0.89	0.30	0.26

Notes: Z = total mortality; M = natural mortality; F = catch mortality;
 E = exploitation rate

Source: Yuliana (2016)

Another example is the status of reef fish exploitation level in Kaledupa Island, Wakatobi National Park. From five species which was being analysed, 3 of them were also over-exploited (Table 2), they are *Siganus canaliculatus*, *Lethrinus ornatus*, dan *Lethrinus variegatus*, with exploitation rate value (E) each of 0.55 and 0.65, and 0.57. The research result from Yuliana (2020), bullet tuna (*Auxis rochei*) in Nusa Penida water area (as a protected marine area), also has undergone overfishing with exploitation rate value (E) of 0.69. As a note, Nusa Penida has pelagic fish and reef fish species (576 species) (Allen & Erdman, 2008), comprising target fish and ornamental fish.

Table 2. The Exploitation Rate of Reef Fish
in Wakatobi National Park

Species	Family	Mortality			E
		M (/year ⁻¹)	F (year ⁻¹)	Z (year ⁻¹)	
<i>Siganus canaliculatus</i>	Siganidae	1.20	1.48	2.68	0.55
<i>Lethrinus harak</i>	Lethrinidae	0.92	0.87	1.79	0.48
<i>Lethrinus ornatus</i>	Lethrinidae	0.98	1.82	2.80	0.65
<i>Mulloidichthys flavolineatus</i>	Mullidae	1.00	0.71	1.71	0.41
<i>Lethrinus variegatus</i>	Lethrinidae	0.99	1.31	2.30	0.57

Notes: Z = total mortality; M = natural mortality; F = catch mortality; E = exploitation rate

Source: Yuliana (2021)

b. Data Availability

Data is a fundamental part in fisheries management. The prediction of fisheries stock in the future could be figured by processing the current data. The policies that can be taken in fisheries management also depend on the data availability in detail towards the

current fisheries situation. Referring to so much overfishing conditions on some of the fish varieties we have here, this has shown how weak the fisheries management in Indonesia is. One of the factors that cause this issue is the lack of data of biology species which have been caught and the data of the fish catching; the lack of discipline from the fishers towards the law made, and weak law enforcement; so far there hasn't been a matching/proper model for the fisheries management (Helfman, 2007).

Indonesia as a country rich with its fish resources has a high number of fish catching results. The recordings for the fish catching results have been done by the Ministry of Marine Affairs and Fisheries (KKP), Indonesia, but not yet recorded specifically for each of the fish species. This is necessary to be done as a factor of determination for the status of fish stock and fisheries management policy. The research done in the fisheries area also needs valid and accurate data.

3. Industrial Revolution 4.0 and Society 5.0

One of the missions of Industrial Revolution 4.0 is to increase productivity effectively and efficiently. Society 5.0 is a concept of life technology development of society in Japan. The technology development will be centralised at human's habit which is based in technology, therefore indirectly this will substitute the human role or supposed this will be potential in degrade the human role. The concept known as Society 5.0 will transform the big data which is obtained and gathered through the internet in all aspects of life and will become a new wisdom to level up human's ability (Firdaus, 2020).

In this era of Society 5.0, everyone from all walks of life (including fishers) are encouraged to think innovatively and critically. Society 5.0 offers a society which is centralised to human itself and build stability between economic improvement and social problem solving (Irawan, 2021). In fisheries area, Industrial Revolution 4.0 and Society 5.0 are expected to significantly give impacts, because the fisheries stakeholders will be more efficient in working with artificial intelligence, competitiveness, and will be able to escalate productivity. The

innovations of technology in Industrial Revolution 4.0 and Society 5.0 are also expected to attract interests from the young generation to grow the fisheries sector in Indonesia (Irawan, 2021).

4. Fisheries Management for Society 5.0

Reflecting on some issues happening in the fisheries management in Indonesia which have been explained before, we need decent solutions that can solve the problems. Industrial Revolution 4.0 and Society 5.0 can give direct impact to the fisheries sector. Industrial revolution which progresses rapidly demands adaptation in fisheries. One of the impacts lies in the analysis and an effective determination on the fisheries management model by utilising digital technology and an advanced fisheries data system. By using valid data, the Indonesian government can easily draft the policies needed for the marine and fisheries sector. As well as research in the fisheries sector, they all need data validity which is available. The draft concept for the policies which is based on valid data analysis (research result) will produce a good output. That is in line with the demand of Industrial Revolution 4.0 and Society 5.0 which says the fisheries sector needs to be brought to the digitalisation era and it can also prosper the fishers as the main 'actor' in fisheries activities.

Producing fish products with global market standards requires fish catching activities that can maintain the cold chains and good-standard packaging system. In order to realise it, there needs to be the best solution taken, by using one of the recent advanced technologies, artificial intelligence. Fishers can use advanced machines which are connected to the internet and do the reporting of the fish catching location in real-time mode / LIVE. Thus, the recording of fish catching results wouldn't need to be done manually, which can also possibly cause some mistakes. The supervision on fish catching activities can also be relying on the location point that's informed by the fisher.

In order to avoid overfishing, the fisheries management also needs an advanced data system. Due to so many fish catching results in Indonesia and high diversity of fish species, it has caused the fisheries data management to require big data. Pertaining to that, IPB University has launched a programme called *argo maritime 4.0*. It's a development for the marine and fisheries which utilises artificial intelligence, drones, big data, digital, robotic, and smart precision. Another technology which can be beneficial is smart fishing, which has real-time quality, precision, multifunction, and has direct marketing ability (Ambari, 2019).

Human resources are an important thing that needs to be prepared to face the Industrial Revolution 4.0 and Society 5.0. The change of activity into digital culture is not easy. Education and training need to be arranged for the human resources preparation, either from the fisher's, government's, students', and stakeholders' circle. Education institutions must also be involved in communities and offer cooperation that can help to lift the life of the coastal community, which also becomes the form of dedication to the community. In this case, Universitas Terbuka as one of the higher institutions, has contributed to preparing human resources which will engage in marine and fisheries areas, by offering some certificate programs that can be taken by fishers to improve their competencies towards the era of marine and fisheries Society 5.0.

CLOSING REMARKS

The large potential of Indonesia's fisheries raises several issues in its management. During the Industrial Revolution 4.0 and Society 5.0, the fisheries sector needed solutions to overcome issues that arise in fisheries management. One of the solutions offered by the Industrial Revolution 4.0 and Society 5.0 is the management of fishery big data using an advanced system. In addition, increasing the capacity of human resources also needs to be prepared in order to welcome the era of the Industrial Revolution 4.0 and Society 5.0.

Regarding the policies to be taken in fisheries management, whatever policies made for the marine and fisheries sector in the era of Industrial Revolution 4.0 and Society 5.0, they must be ensured to prosper the fishers and also among other stakeholders.

REFERENCES

- [1] Allen, G.R. Dan M.V. Erdman. 2008. Reef Fish Of Nusa Penida, Indonesia. Final Report To Conservation International. 22 Hlm.
- [2] Ambari, M. (2019). Laut Indonesia Butuh Teknologi Dan Data Akurat. <https://www.mongabay.co.id/2019/11/13/Laut-Indonesia-Butuh-Teknologi-Dan-Data-Akurat> (Accessed On 26 September 2021).
- [3] Kementerian Kelautan Dan Perikanan (Kkp). 2021. Produksi Perikanan. [Produksi Perikanan \(Kkp.Go.Id\)](http://Kkp.Go.Id) [Produksi Perikanan \(Kkp.Go.Id\)](http://Kkp.Go.Id).
- [4] Dewan Pertimbangan Presiden (Dpp). 2017. Potensi Perikanan Indonesia. <https://wantimpres.go.id/potensi-perikanan-indonesia/> (Accessed 20 September 2021).
- [5] Food And Agricultural Organization (Fao). 2016. *The State Of World Fisheries And Aquaculture 2016*. Rome: Fao.
- [6] Food And Agricultural Organization (Fao). 2020. *The State Of World Fisheries And Aquaculture 2020*. Rome: Fao.
- [7] Froese R & Pauly D. Editors. 2013. Fish Base. Worl Wide Web Electronic Publication. www.fishbase.org. Version (04/2013).
- [8] Hendriyana, A. 2021. Sektor Perikanan Tangkap Indonesia Punya Polemik Yang Kompleks. Sektor Perikanan Tangkap Indonesia Punya Polemik Yang Kompleks – Universitas Padjadjaran (Unpad.Ac.Id) (Accessed On 23 September 2021).
- [9] Firdaus. 2020. Mengenal Society 5.0: Sebuah Upaya Masyarakat Jepang Untuk Keamanan Dan Kesejahteraan Manusia. <https://ee.uji.ac.id/2020/07/06/mengenal-society-5-0-sebuah-upaya-jepang-untuk-keamanan-dan-kesejahteraan-manusia/> (Accessed On 26 September 2021).

- [10] Helfman Gs. 2007. Fish Conservation. Washington: Island Press.
- [11] Irawan, I.B. 2021. Sdm Pertanian Di Era Revolusi Industri 4.0 Dan Society 5.0. <https://Rri.Co.Id/Jakarta/Layanan-Publik/1099739/Sdm-Pertanian-Di-Era-Industri-4-0-Dan-Society-5-0> (Accessed On26 September 2021).
- [12] Syafei, L.S. 2017. Keanekaragaman Hayati Dan Konservasi Ikan Air Tawar. *Jurnal Penyuluhan Kelautan Dan Perikanan Indonesia* 11 (1): 48-62.
- [13] Yuliana, E. 2016. Pengelolaan Perikanan Karang Dengan Pendekatan Ekosistem Di Kawasan Konservasi (Kasus: Taman Nasional Karimunjawa). Disertasi. Sekolah Pascasarjana Institut Pertanian Bogor, Bogor.
- [14] Yuliana, E., M. Boer, A. Fahrudin, Dan E. Muttaqin. 2016. Status Stok Ikan Karang Target Di Kawasan Konservasi Taman Nasional Karimunjawa. *J. Penelitian Perikanan Indonesia* 22(1): 9-16.

DEVELOPMENT OF CRISPR/CAS9 PLASMID FOR GENE EDITING OF EGFR_{vIII} GENE OF GLIOBLASTOMA MULTIFORME

Diki¹, Mutimanda Dwisatyadini², Wahyu Widowati³,
Ervi Afifah⁴, Cintani Dewi Wahyuni⁵, Jenifer Kiem Aviani⁶

*^{1,2}Department of Biology, Faculty of Science and Technology,
Universitas Terbuka (INDONESIA)*

³Faculty of Medicine, Maranatha Christian University (INDONESIA)

^{4,5,6}Aretha Medika Utama, Bandung (INDONESIA)

dikinian@ecampus.ut.ac.id

Abstract

This study is to develop CRISPR/Cas9 plasmid for gene editing in glioblastoma multiforme (GBM). GBM is the most lethal type of cancer. There is no effective treatment for GBM. So far, treatment for GBM are radiotherapy, chemotherapy, and surgery. However, those treatment do not provide any effective result, while recurrence rate are still high. The CRISPR/Cas9 gene editing may provide treatment for patients of glioblastoma multiforme, by knocking off EGFR_{vIII} gene, an oncogene for this cancer. In this study, we design, isolate, and verify CRISPR. We achieved a purity level of 1.8 and concentration of 38,1 ug/mL. However, we need to do further verification, prior to do the next steps, which are insertion and ligation of sgRNA into the plasmid.

Keywords: CRISPR/Cas9, plasmid, glioblastoma multiforme, EGFR_{vIII} cancer.

1 INTRODUCTION

Glioblastoma multiforme (GBM) is one of the most difficult cancer to treat. Its survivability rate is low, as most patients can only live for 15-18 months after diagnosed with GBM. Meanwhile, its recurrence rate is high (Prieto & de La Fuente, 2021; Sepulveda et. al, 2017).

EGFR gene is the firstly found GBM oncogene (Prieto & de La Fuente, 2021). This gene produces epidermal growth factor (EGF) protein. It is also a transmembran glycoprotein. EGFRvIII is the most prominent mutation of EGFR in GBM (Sepulveda et. al, 2017).

Clustered regularly interspaced short palindromic repeats (CRISPR) is one of the promising technique for editing gene. The technique include CRISPR-associated proteins (Cas) systems.

The aim of this study is to develop a plasmid containing sgRNA and Cas9 to knock out EGFRvIII gene responsible for GBM. This is the beginning of those steps, which covers the design, isolation and optimization of plasmid.

2 METHODOLOGY

The first step is designing sgRNA, using NCBI website to search the mRNA. In online CRISPR design tools, we copy the sequence number to improve efficiency and reducing off-target sequence. We took first three sequence as candidates of sgRNA. The researchers purchased the designed plasmid *pSpCas9n(BB)-2A-Puro* from Addgene. This plasmid is sent as bacterial agar stab. This bacteria is cultured in Luria Bertani Broth (LBB) medium. This bacteria is cultured in agar media. Then, the plasmid is incubated in temperature of 37^o C for 24-48 hours until a single colony appears. We incubate the single colony into lactose broth media that is added by 100 ug/mL of ampicillin. The incubation last for 2 days in 37^oC temperature. The isolation process uses miniprep plasmid isolation kit.

3 RESULTS

In the first plasmid incubation, there was no growth of bacteria in the culture (Figure 1). Therefore, there researcher repurchase the plasmid.

In the second trial, there was a purity level of 1.8 and concentration of 38,1 ug/mL.



Figure 1. Bacterial Culture contain pSpCas9n (BB)-2A-Puro and Cas-9 Recombinant

In this step, the researchers did not verify the plasmid yet. There is only one band during electrophoresis (Figure 2). There should be more optimization of plasmid restriction using FastDigestBbcI kit. There should also be optimization in electrophoresis. So far, there are 4 iteration of electrophoresis. Next step is bacterial culture in glicerol stock and another plasmid isolation.

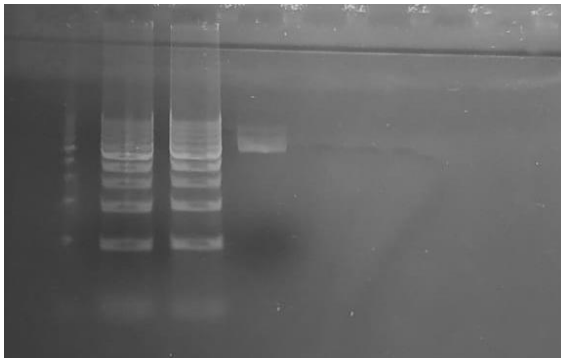

Figure 2. Gel Electrophoresis Result for Confirming the Plasmid Recombinant

4 CONCLUSIONS

This study achieved growth of plasmid for CRISPR/Cas9 with 1.8 level of purity and concentration of 38,1 ug/mL. However, the verification were still unsuccessful. Therefore, there should be more focus on the verification, prior to moving into ligation step.

REFERENCES

- [1] Daisy, P. S., Shreyas, K. S., & Anitha, T. S. (2021). Will CRISPR-Cas9 Have Cards to Play Against Cancer? An Update on its Applications. *Molecular Biotechnology*, 1-16. Huang, K., Yang, C., Wang, Q. X., Li, Y. S., Fang, C., Tan, Y. L., ... & Kang, C. S. (2017). The CRISPR/Cas9 system targeting EGFR exon 17 abrogates NF- κ B activation via epigenetic modulation of UBXN1 in EGFRwt/vIII glioma cells. *Cancer letters*, 388, 269-280.
- [2] Kim, H. M., Lee, S. H., Lim, J., Yoo, J., & Hwang, D. Y. (2021). The epidermal growth factor receptor variant type III mutation frequently found in gliomas induces astrogenesis in human cerebral organoids. *Cell proliferation*, 54(2), e12965
- [3] Luo Y. CRISPR Gene Editing: Methods and protocols. 2019. Denmark: Humana Press
- [4] Ma Y, Zhang L, Huang X. Genome modification by CRISPR/Cas9. *FEBS Journal* 2014; 281(23): 5186-5193. Doi: 10.1111/febs.13110
- [5] Majc, B.; Novak, M.;Kopitar-Jerala, N.; Jewett, A.; Breznik, B. (2021). Immunotherapy of Glioblastoma: Current Strategies and Challenges in Tumor Model Development. *Cells*, 10, 265. <https://doi.org/10.3390/cells10020265>
- [6] Prieto, M. D. P. G., & de La Fuente, M. I. The Role of Molecular Genetics of Glioblastoma in the Clinical Setting. *Precision Molecular Pathology of Glioblastoma*, 21.

- [7] Sepúlveda, J. M., Zahonero, C., & Gómez, P. S. (2017). Targeting EGFR in glioblastoma: molecular biology and current understanding. In *Advances in Biology and Treatment of Glioblastoma* (pp. 117-141). Springer, Cham.
- [8] van der Weyden, L., Jonkers, J., & Adams, D. J. (2021). The use of CRISPR/Cas9-based gene editing strategies to explore cancer gene function in mice. *Current Opinion in Genetics & Development*, 66, 57-62.

TYPES OF MANGROVES WITH POTENTIAL AS MEDICINE PLANTS IN MANGROVE VEGETATION AREA, BLANAKAN DISTRICT, SUBANG, WEST JAVA

**Mutimanda Dwisatyadini¹, Susi Sulistiana²,
Ludivica Endang Setijorini³**

*¹Biology Study Program, Faculty of Science and Technology,
Universitas Terbuka (INDONESIA)*

*²Agribusiness Study Program, Faculty of Science and Technology,
Universitas Terbuka (INDONESIA)
mutimanda@ecampus.ut.ac.id*

Abstract

There are several types of mangroves that have the potential as traditional medicine. The parts of the mangrove used for traditional medicine are leaves, sap, fruit, and all parts of the plant. Research purposes are identify the compounds contained in the extract types of mangrove. This research was sampling four types of mangroves *Acrostichum aureum* (Warakas mangrove), *Sonneratia caseolaris* (Red Pidada mangrove), *Rhizophora apiculata* (white mangrove), and *Avicennia* sp (Api-Api mangrove), in Blanakan Village, Subang, West Java, Indonesia. The samples taken from mangrove plants were the leaves, stems, roots, flowers, and fruit. The samples were then tested for phytochemicals at the Bogor Agricultural Institute's Biopharmaceutical Laboratory. Qualitative phytochemical test with positive for flavonoid, tannins, saponins, phenolic, and steroids, terpenoid compounds are *Sonneratia caseolaris* (Red Pidada mangrove), *Rhizophora apiculata* (white mangrove), and *Avicennia* sp (Api-Api mangrove). This means that the 3 kinds of mangrove contains secondary metabolites that are antioxidative. Quantitative phytochemical test with the highest flavonoid content yield was *Sonneratia caseolaris* (Red Pidada mangrove) leaves. It is from 100 grams of *Sonneratia caseolaris* (Red Pidada mangrove) leaves there

were 0,078 and 0.097 grams of flavonoids equivalent to quercetin which functioning as antioxidants.

Keywords: Types of Mangrove, Potential as traditional medicine, Positive antioxidative compounds.

1 INTRODUCTION

Mangroves are natural resources have an important role in maintaining the balance between terrestrial and aquatic ecosystems. Therefore, this ecosystem is also a life supporter that needs to be preserved (Indrayanti et al., 2015). There are 22 types of mangroves that have the potential as traditional medicine. The parts of the mangrove used for traditional medicine are leaves, sap, fruit, and all parts of the plant. The types of mangroves, such as Jeruju (*Acanthus ilicifolius*) for cancer and diabetes drugs, Nipa (*Nypa fruticans*) for asthma and diabetes medication, other Mangroves (*Rhizophora apiculata*, *Bruguiera cylindrical*, *Bruguiera gymnorhiza*, *Rhizophora mucronata*, *Ceriops tagal*, *Bruguiera exaristata*, *Sonneratia alba*, and *Sonneratia ovata*) for antiseptic drugs and drugs for several types of diseases, such as hepatitis, eye pain, ulcers, swelling, diarrhea, anti-vomiting, itching, headache, stomachache, smallpox, thrush, asthma, healing kind of benign tumor (Sari, 2008; Simanjuntak, 2008; Darwis, 2012).

Api-api (*Avicennia alba*; *Avicennia marina*) contains antioxidants, as well as for rheumatism and toothache. Beluntas (*Pluchea indica*) for body odor. Jenu (*Derris trifoliata*) for laxative. Tapak Kuda (*Ipomoea pescaprae*) for healing wounds and ulcers. Sea Paku (*Acrostichum aureum*; *Acrostichum speciosum*) contains antioxidants, as well as for arteriosclerosis, brain dysfunction, diabetes, and cancer. *Sesuvium portulacastrum*, *Xylocarpus granatum*, *Excoecaria agallocha* has antibacterial properties, for typhoid, stomachache, itching, eye pain. *Melastoma malabathricum* has properties as a fever reducer (antipyretic), analgesic, diuretic, treating burns or bleeding wounds, inflammation of the walls of blood vessels accompanied by blood clots in the tract. *Lumnitzera racemosa* for stomach pain

medicine (Sari, 2008; Simanjuntak, 2008; Darwis, 2012; Sarno, Marisa, and Sa'diah, 2013; Suwardi, Tambaru, Ambeng, Priosambodo, 2013; Supriyanto, Indriyanto, and Bintoro, 2014; Henny, Diba, and Anwari, 2017; Eriani and Usman, 2017; Puspitasari, 2017).

There are many types of mangrove vegetation in Blanakan Village, Subang Regency, such as *Avicennia marina* (Api-api), *Rhizophora mucronata* (Red Mangrove), *Rhizophora apiculata* (White Mangrove), *Acanthus ilicifolius* (Jeruju), *Sonneratia acida*, and *Sonneratia alba* (Pidada). examined its benefits as medicinal plants (Rachmawati, 2012; Rahman, Pato, & Harun, 2016). Meanwhile, the mangrove vegetation type *Acrostichum aureum* (Warakas) has been used by the Kanagarian Mangguang Pariaman community in their daily life (Rizki, Sari, & Leilani, 2012). However, the mangrove vegetation types *Acrostichum aureum* (Warakas) and *Sonneratia caseolaris* (Pidada Merah) have not been widely studied for their benefits as medicinal plants. Hanin and Pratiwi (2017) stated that Paku Laut (*Acrostichum aureum* L) leaves contain moderate phenolic compounds and moderate levels of antioxidants. The type *Sonneratia caseolaris* (Pidada Merah) contains fatty acid compounds, sterols, hydrocarbons, and two flavonoids that function as antioxidants (Herwinda and Amir, 2013). Supported research by Hasanah, Ahmad, & Rijai (2015) the results of testing the activity of sunscreen extracts and leaves fractions of *Sonneratia caseolaris* (Pidada Merah) in vitro contain phenolic compounds, flavonoids, saponins, carotenoids and tannins, so that the leaves function as antioxidants and can absorb sunlight. Which can be used as a sunscreen. Based on the above background, the authors are interested in conducting research on the Identification of Potential Mangrove Types as Medicinal Plants in Blanakan District, Subang, West Java.

2 METHODOLOGY

This research was conducted for 9 months, from March to November 2018. The research sample was taken in the Mangrove Vegetation Area in Blanakan Village, north coast of Blanakan District,

Subang Regency, West Java. The phytochemical content test of mangrove samples was carried out at the Bogor Biopharmaceutical Laboratory. The research procedure begins with sampling four types of mangroves *Acrostichum aureum* (Warakas), *Sonneratia caseolaris* (Pidada Merah), *Rhizophora apiculata* (white mangrove), and *avicennia* sp (api-api mangrove) at the location of Blanakan Village. The samples taken from mangrove plants were the leaves, stem, roots, floral, and fruit. The samples were then tested for phytochemicals in the laboratory (Ernianingsih, Mukarlina, & Rizalinda, 2014; Novianty, Sastrawibawa, & Pribadi, 2011). Phytochemical screening is an approach method that can be used to determine the presence of plant secondary metabolites. The group of metabolites of phytochemical tests includes tests for Alkaloids, Terpenoids, Phenols, Flavonoids, Saponins, Steroids, and Tannins (Achmad, 2009).

Sample preparation are the leaves, stems, roots, flowers, and fruits of *Acrostichum aureum* (Warakas) and *Sonneratia caseolaris* (Pidada Merah), as well as White Mangroves and ripe Apis are cleaned. Then the fruit is peeled, so that the skin is obtained. Then the leaves, stems, flowers, fruit skins, and roots are dried by aerating in an open space for 7-10 days to dry, then blended into 1 kg of flour, ground to a powder. Then macerated with methanol 3 x 24 hours (Khasnah, Rastuti, & Handayani, 2012).

Maceration total of 300 grams of powdered fruit peels, flowers, leaves, roots and stems from four types of mangroves *Acrostichum aureum* (Warakas) and *Sonneratia caseolaris* (Pidada Merah), as well as White Mangroves and Api-api were extracted by maceration using methanol for 24 hours while occasionally stirred, then filtered using a Buchner funnel to obtain the filtrate and residue. Maceration was repeated several times until the extraction was clear. The methanol extract was then concentrated and divided into two parts. One part of the extract is referred to as methanol extract (EM), and the other part is fractionated by maceration with n-hexane solvent, so that the n-hexane fraction of methanol extract and residue is obtained. Then the

n-hexane fraction of the methanol extract obtained was concentrated and weighed (FH), while the residue from the n-hexane fractionation was dried by aerating. The residue from the dry fractionation with n-hexane was again fractionated using ethyl acetate solvent, and the ethyl acetate fraction of methanol extract and residue was obtained. The ethyl acetate fraction of the methanol extract was concentrated so that the ethyl acetate fraction of the concentrated methanol extract was then weighed, and the resulting residue was dried (Khasnah, Rastuti, & Handayani, 2012).

Alkaloid test, 2 mL of sample ($\pm 0.05\%$ w/v) was dissolved in 2 mL of 2% HCl (v/v), then heated for 5 minutes and filtered. The filtrate obtained was dripped with 2-3 drops of Dragendroff's reagent. The presence of alkaloid compounds is indicated by the formation of an orange or orange colored precipitate. Furthermore, Meyer and Wagner reagents were added to each test tube. The presence of alkaloids was indicated by the formation of a white precipitate with Meyer's reagent and an orange to red-brown precipitate with Wagner's reagent. The negative reaction did not indicate any precipitate in each reagent (Darwis, 2000; Khasnah, Rastuti, & Handayani, 2012).

Terpenoid test, 2 mL sample ($\pm 0.05\%$ w/v) was added with 1 mL Liebermann-Burchard reagent. A positive test is indicated by the formation of a purple color. Positive reactions are indicated by a red or purple color change, while negative reactions do not show a red or purple color change (Kadarisman, 2000; Khasnah, Rastuti, & Handayani, 2012).

Phenol test, 2 mL ($\pm 0.05\%$ w/v) sample was dissolved in 10 mL distilled water, heated for 5 minutes and filtered. The filtrate was added 4-5 drops of 2.5% (w/v) FeCl₃. The presence of phenol is indicated by the formation of a dark blue or blackish green color. Positive reactions are indicated by the formation of green, blue or purple colors, while negative reactions do not show the color change (Kadarisman, 2000; Khasnah, Rastuti, & Handayani, 2012).

Flavonoid Test. A sample of 2 mL ($\pm 0.05\%$ w/v) was dissolved in 2 mL of methanol, then 5 drops of concentrated Mg and HCl powder were added. The presence of flavonoid compounds is indicated by the formation of a red or orange color. The positive reaction of flavonoids is indicated by the formation of a red, yellow, or orange color, while the negative reaction does not form a red color (Sutisna, 2000; Khasnah, Rastuti, & Handayani, 2012).

Saponin Test. A sample of 2 mL ($\pm 0.05\%$ w/v) was dissolved in distilled water in a test tube and shaken for 15 minutes. The presence of saponin compounds is indicated by the formation of foam as high as 1 cm and remains stable for 15 minutes (Khasnah, Rastuti, & Handayani, 2012).

Steroid Test. A total of 2 mL of sample ($\pm 0.05\%$ w/v) was added with 1 mL of Liebermann-Burchard reagent. The presence of steroid compounds is indicated by the formation of a green or blue color. Positive results indicate the presence of a turquoise color (Sumardjo, 2006; Khasnah, Rastuti, & Handayani, 2012). **Tannin Test.** As much as 0.5 gram of Suruhan extract sample was added 1 ml of distilled water and 2 drops of 1% FeCl₃. Positive results indicate the presence of brown color (Sumardjo, 2006; Khasnah, Rastuti, & Handayani, 2012).

Phytochemical test results were analyzed in 2 ways. It is a qualitative and quantitative observations. The study was conducted with 2 repetitions so that the average value was obtained. The data that has been obtained from the absorbance value to be tested for antioxidant activity is then calculated by the formula: % antioxidant activity = absorbance of the blank (absorbance of DPPH) - absorbance of the sample (absorbance of extract) divided by absorbance of the blank (absorbance of DPPH) multiplied by 100%. After getting the percent inhibition, a curve was made between the concentration (x) and the % inhibition (y) and obtained the linear regression equation and the table of antioxidant activity test results. The results of phytochemical observations are presented in the form of a table that is qualitative in nature and if the results are positive, it is followed by a quantitative test for flavonoids.

3. RESULTS

Identification of compounds contained in the extracts of mangrove species *Acrostichum aureum* (warakas), *Sonneratia caseolaris* (red pidada), *Rhizophora apiculata* (white mangrove), *Avicennia* sp (Api-Api) leaves which are useful as medicinal plants in the form of phytochemical test results Qualitatively presented in table 1.

Table 1. Qualitative Phytochemical Test Results.

Test material	Flavonoid	Alkaloid			Tanin	Saponin	Fenol	Steroid	Terpenoid
		Mayer	Wagner	Dragendrof					
<i>Acrostichum aureum</i> leaf 1	-	-	-	-	+	++	-	+++	-
<i>Acrostichum aureum</i> leaf 2	-	-	-	-	-	++	-	++	-
<i>Acrostichum aureum</i> root 1	-	-	-	-	-	-	-	-	-
<i>Acrostichum aureum</i> root 2	-	-	-	-	-	-	-	-	-
<i>Sonneratia caseolaris</i> leaf 1	++	-	-	-	+++	+	-	+++	-
<i>Sonneratia caseolaris</i> leaf 2	+	-	-	-	+++	-	-	+++	-
<i>Sonneratia caseolaris</i> floral 1	+	-	-	-	+++	++	-	+	-
<i>Sonneratia caseolaris</i> floral 2	+	-	-	-	+++	++	-	+	-
<i>Sonneratia caseolaris</i> fruit1	+	-	-	-	+	+	-	+	-
<i>Sonneratia caseolaris</i> fruit 2	+++	-	-	-	+++	+	-	+	-
<i>Sonneratia caseolaris</i> stem 1	-	-	-	-	+	-	-	+	-
<i>Sonneratia caseolaris</i> stem 2	+	-	-	-	+	+	-	+	-
<i>Sonneratia caseolaris</i> root 1	-	-	-	-	+	+	-	+	-
<i>Sonneratia caseolaris</i> root 2	-	-	-	-	+	+	-	+	-

Test material	Flavonoid	Alkaloid			Tanin	Saponin	Fenol	Steroid	Terpenoid
		Mayer	Wagner	Dragendrof					
Rhizophora apiculata leaf 1	-	-	-	-	+	++	-	+++	-
Rhizophora apiculata leaf 2	-	-	-	-	++	++	-	+++	-
Rhizophora apiculata floral 1	-	-	-	-	+++	++	-	++	-
Rhizophora apiculata floral 2	-	-	-	-	+	+	-	++	-
Rhizophora apiculata fruit 1	-	-	-	-	-	+	-	++	-
Rhizophora apiculata fruit 2	-	-	-	-	+	++	-	+	-
Rhizophora apiculata root 1	+	-	-	-	-	+	-	+	-
Rhizophora apiculata root 2	-	-	-	-	+	+	+	+	-
Rhizophora apiculata stem	+	-	-	-	+	+	+	+	-
Avicennia sp leaf	++	-	-	-	-	++	-	++	-
Avicennia sp stem	-	-	-	-	-	+	-	+	-

Source: Primary Data, (2018).

Notes:

- : Negative or does not contain secondary metabolites.
- + : Positive Weak or contains weak secondary metabolites.
- ++ : Strong Positive or contains strong secondary metabolites.
- +++ : Positive Very Strong or contains very strong secondary metabolites.

The results in table 1 show that sample 1 of *Acrostichum aureum* l leaves was weakly positive containing metabolites of tannin, strong positive containing metabolites of saponin, very strong positive containing metabolites of steroid. The samples of 2 *Acrostichum aureum* leaves were strongly positive containing metabolites of saponin and steroid. Samples of 1 *Sonneratia caseolaris* leaves were weakly positive containing metabolites of saponin, strong positive

containing metabolites of flavonoid, very strong positive containing metabolites of tannin and steroid. Samples of 2 *Sonneratia caseolaris* leaves were weak positive containing metabolites of flavonoid, very strong positive containing metabolites of tannin and steroid. Samples 1 and 2 of *Sonneratia caseolaris* floral were weakly positive containing metabolites of flavonoid and steroid, strong positive containing metabolites of saponin, very strong positive containing metabolites of tannin.

Samples of 1 *Sonneratia caseolaris* fruits were weakly positive containing metabolites of flavonoid, tannin, saponin and steroid. Sampels of 2 *Sonneratia caseolaris* fruits were weakly positive containing metabolites of saponin and steroid. It was very strong positive containing metabolites of flavonoid and tannin. Samples of 1 *Sonneratia caseolaris* stem were weakly positive containing metabolites of tannin and steroid. Samples of 2 *Sonneratia caseolaris* stem were weakly positive containing metabolites of flavonoid, tannin, saponin and steroid. Samples of 1 and 2 *Sonneratia caseolaris* roots were weakly positive containing metabolites of tannin, saponin, and steroid.

Sampel of 1 *Rhizophora Apiculata* leaves were weakly positive containing metabolites of tannin, strong positive containing metabolites of saponin, very strong positive containing metabolites of steroid. Sampel of 2 *Rhizophora Apiculata* leaves were strong positive containing metabolites of tannin and saponin, very strong positive containing metabolites of steroid. Sampel of 1 *Rhizophora Apiculata* floral were strong positive containing metabolites of saponin and steroid, very strong positive containing metabolites of tannin. Sampel of 2 *Rhizophora Apiculata* floral were weakly positive containing metabolites of tannin and saponin, strong positive containing metabolites of steroid. Sampel of 1 *Rhizophora Apiculata* Fruit was weakly positive containing metabolites of saponin and strong positive containing metabolites of steroid. Sampel of 2 *Rhizophora Apiculata* Fruit was weakly positive containing metabolites of tannin and steroid. It was strong positive containing metabolites of saponin. Sampel of 1

Rhizophora Apiculata roots was weakly positive containing metabolites of tannin, saponin, and steroid. Sampel of 2 Rhizophora Apiculata roots was weakly positive containing metabolites of tannin, saponin, steroid, and Phenolic. Sampel of Rhizophora Apiculata stem was weakly positive containing metabolites of flavonoid, tannin, saponn, phenolic, steroid.

Sampel of Avicennia sp leaves was strong positive containing metabolites of flavonoid, saponin, steroid. And Sampel of Avicennia sp stem was weakly positive containing metabolites of saponin and steroid. Supported by research by Herwinda & Amir, (2013) Sonneratia caseolaris (red pidada) which contains fatty acid compounds, sterols, hydrocarbons, and two flavonoids that function as antioxidants. Supported by research by Hasanah, Ahmad, & Rijai (2015) the results of testing the activity of sunscreen extracts and leaves fractions of Sonneratia caseolaris (red pidada) in vitro contain phenolic compounds, flavonoids, saponins, carotenoids and tannins, so that the leaves function as antioxidants and can absorb sunlight. which can be used as a sunscreen. Supported by research by Niken, Leilani, Putri, and Gusti, (2019), the results of phytochemical analysis showed that Sonneratia casiolaris fruit contains alkaloids, flavonoids, phenolic compounds, tannins and steroids.

Acrostichum aureum (Warakas) plants produce more phenolic compounds. The largest group of phenolic compounds are flavonoids. Warakas plants have been known to contain high levels of phenolic compounds in the leaves, stems and roots. Young shoots can be eaten raw as a salad or cooked (Malay, India, Sri Lanka) (Hanin, 2016). Supported by research by Hanin and Pratiwi, (2017) stated that the spore sample showed a flavonoid content of 2.32 mg/mL, and antioxidant activity with an IC₅₀ value of 23.25 ppm. Thus, the ethanolic extract of sea fern leaves spores showed the highest flavonoid content, and could be categorized as a very strong antioxidant.

The bioactive compounds identified from *Rhizophora* are flavonoids, saponins, tannins, triptenoids, steroids, and phenols (Mile, Nursyam, Setijawati, and Sulistiyati, 2021). Supported by research by Nur, Eso, Rorano, and Suaibun, (2019) stated that Bioactive compounds identified as *Rhizophora* sp. leaves samples contain bioactive compounds saponins and steroids. Bark contains bioactive compounds alkaloids, flavonoids, saponins and steroids, and roots contain bioactive compounds saponins and steroids. Research by Ridlo, Supriyantini, and Sedjati, (2019) . The results indicated promising mangrove *Rhizophora* sp. for the utilization as a significant source of natural antioxidants.

The result of proximate analysis showed that api-api's leaves was high in crude fiber (4.12%) and carbohydrate (23.00%). Ethyl acetate extract of api-api's leaves showed higher antioxidant activity than hexane and methanol extracts, with IC50 value is 182.33 ppm. The ethyl acetate extract in concentration 300 ppm had higher ability to inhibit autooxidation that occurred in oil/water emulsion. Flavonoids, steroids and reducing sugar were detected in api-api leaves extract (Jacob, A.M., Purwaningsih, S., and Rinto, 2011). Supported by Alhaddad, Tanod, and Wahyudi, (2019) stated that phytochemical analysis of various solvent extracts showed that flavonoids and tannins were common in all plant extracts with antibacterial properties. *Avicennia* sp. leaves extract. can be used to find new bioactive natural products and can be used as a potential source that can control pathogenic bacteria.

In conclusion Qualitative phytochemical test: A *Sonneratia caseolaris* (red pidada) leaves, floral, stem fruit, roots, *Rhizophora Apiculata* stem, *Avicennia* sp leaves that are positive for flavonoid compounds, tannins, saponins, phenolic, and steroids. antioxidant and antibacterial properties. So that it can be used as a medicinal plant or healthy food.

Table 2. Quantitative Test Results for Flavonoid Compounds

No.	Sample	Results	Unit	Legibility
1	Sonneratia caseolaris leaf 1	0,078	%(b/b) (grams)	100 grams of Sonneratia caseolaris leaf 1 contains 0.078 grams of flavonoids which are equivalent to quercetin which functions as antioxidants.
2	Sonneratia caseolaris leaf 2	0,097	%(b/b) (grams)	100 grams of Sonneratia caseolaris leaf 2 contains 0.097 grams of flavonoids which are equivalent to quercetin which functions as antioxidants.
3	Sonneratia caseolaris floral 1	0,010	%(b/b) (grams)	100 grams of Sonneratia caseolaris floral 1 contains 0.010 grams of flavonoids which are equivalent to quercetin which functions as antioxidants.
4	Sonneratia caseolaris floral 2	0,020	%(b/b) (grams)	100 grams of Sonneratia caseolaris floral 2 contains 0.020 grams of flavonoids which are equivalent to quercetin which functions as antioxidants.
5	Sonneratia caseolaris fruit 1	0,019	%(b/b) (grams)	100 grams of Sonneratia caseolaris fruit 1 contains 0.019 grams of flavonoids which are

No.	Sample	Results	Unit	Legibility
				equivalent to quercetin which functions as antioxidants.
6	Sonneratia caseolaris fruit 2	0,021	%(b/b) (grams)	100 grams of Sonneratia caseolaris fruit 2 contains 0.021 grams of flavonoids which are equivalent to quercetin which functions as antioxidants.
7	Rhizophora apiculata root 1	0,022	%(b/b) (grams)	100 grams of Rhizophora apiculata root 1 contains 0.022 grams of flavonoids which are equivalent to quercetin which functions as antioxidants.

Source: Primary Data, (2018).

Table 2 shows that from 100 grams of *Sonneratia caseolaris* leaves 2 contain more antioxidants than *Sonneratia caseolaris* leaves 1, contains is 0.097 grams and 0.078 grams of flavonoids which are equivalent to quercetin which functions as antioxidants, while *Sonneratia caseolaris* floral 2 contain more antioxidants. compared to *Sonneratia caseolaris* floral 1, contains is 0.020 and 0.010 grams of flavonoids which are equivalent to quercetin which functions as antioxidants.

Sonneratia caseolaris fruit 2 contains more antioxidants than *Sonneratia caseolaris* fruit 1, contains is 0.021 grams and 0.019 grams of flavonoids which are equivalent to quercetin which functions as antioxidants. And from 100 grams of *Rhizophora apiculata* 1 root contains 0.022 grams of flavonoids which are equivalent to quercetin which functions as an antioxidant.

Sonneratia caseolaris is a true mangrove plant that has antioxidants and cytotoxics and has many benefits. Antioxidants and cytotoxins from four Philippine medicinal plants stated that triterpenoids, steroids, flavonoids and carboxyl benzene derivatives found in plant and fruit extracts functioned as anti-inflammatory, analgesic, anti-oxidant, anti-allergic, anti-fungal, anti-microbial, and others. Triterpenoids can also function in the prevention and treatment of hepatitis. Flavonoids found in plant extracts can also be used in the treatment of rheumatism. The young leaves of the plant can be used as fresh vegetables and the extract is also useful in inhibiting bleeding Lestari (2017). Supported by the research of Putri, Yulita, and Rijai, (2015) stated that the red pidada fruit peel extract has good antioxidant activity. Supported by research by Santoso, Febrianti, and Nurjanah, (2010) There was a positive relationship between total phenol content, the composition of the phytochemical and antioxidant activity in methanol extracts.

In conclusion, quantitative phytochemical test: the highest yield of flavonoid content was *Sonneratia caseolaris* leaves 2 and 1, contains is 0.097 and 0,078 grams of flavonoids equivalent to quercetin functioning as antioxidants.

4 CONCLUSIONS

The Qualitative phytochemical test: A *Sonneratia caseolaris* (red pidada) leaves, floral, stem fruit, roots, *Rhizophora Apiculata* stem, *Avicennia* sp leaves that are positive for flavonoid compounds, tannins, saponins, phenolic, and steroids. antioxidant and antibacterial properties. So that it can be used as a medicinal plant or healthy food. The Quantitative phytochemical test: the highest yield of flavonoid content was *Sonneratia caseolaris* leaves 2 and 1, contains is 0.097 and 0,078 grams of flavonoids equivalent to quercetin functioning as antioxidants.

ACKNOWLEDGEMENTS

Specials Thanks to Bogor Agricultural Institute's Biopharmaceutical Laboratory and research institutions and community service Universitas Terbuka was funded this research.

REFERENCES

- [1] Alhaddad, Z.A., Tanod, W.A., and Wahyudi, D. (2019). ANTIBACTERIAL BIOACTIVITY OF MANGROVE LEAF EXTRACTS AVICENNIA SP. *Marine Journal*.12(1). Page. 12-22.
- [2] Ahmad, Zein. (2009). *Marketing and salesmanship application*. Jakarta: Media Discourse Partners.
- [3] Darwis, W. (2012). Medicinal Plants Found in Bengkulu City which have the Potential as Medicines for Diseases and Disorders of the Human Digestive System. *Journal of Biological Conservation*.,8 (1):1-15.
- [4] Dervish, D. (2000). Basic laboratory techniques in researching compounds of biological natural materials. Workshop Paper on Human Resource Development in the Field of Organic Chemistry of Natural Biological Materials. Padang: Faculty of Mathematics and Natural Sciences, Andalas University.
- [5] Eriani, I.R., & Usman. (2017). Secondary metabolite compounds of *Sonneratia Alba* mangrove leaf methanol extract and their toxicity properties. *Proceedings of the National Seminar on Chemistry*, Mulawarman University. Pages: 129-132.
- [6] Ernianingsih, S.W, Mukarlina, & Rizalinda. (2014). Ethno pharmacology of mangroves *Achantus ilicifolius* L., *Acrostichum speciosum* L. and *Xylocarpus rumphii* Mabb. in Sungai Tekong Village, Sungai Kakap District, Kubu Raya Regency. *Journal of Protobiont*., 3(2): 252-258.
- [7] Hanin, N.N.F. (2016). The content of total phenolic, flavonoid and antioxidant activity of the ethanol extract of the fertile and sterile sea fern leaf (*Acrostichum aureum* L.) in the mangrove area of Kulon Progo, Yogyakarta. [Essay]. Yogyakarta: UGM.

- [8] Hanin, N.N.F., and Pratiwi, R.(2017). Phenolic Content, Flavonoids and Antioxidant Activity of Leaf Extract of Fertile and Sterile Sea Paku (*Acrostichum aureum* L.) Leaf Extract. *J. Trop. Biodiv.Biotech.* 2(2017).Page.51-56.DOI:10.22146/jtbb.29819.
- [9] Hasanah, S., Ahmad, I., and Rijai, L. (2015). Sunscreen Profile Extract and Fraction of Red Pidada Leaf (*Sonneratia caseolaris* L.). *Journal of Science and Health.*, 1(4): 175-180.
- [10] Henny, Diba, F, & Anwari, S. (2017). Mangrove plants that have the potential as medicine in the PT. *Kandelia Alam*, Kubu District, Kubu Raya Regency. *Journal of Sustainable Forests.*, 5(4): 1100-1110.
- [11] Hewinda, S., and Amir, M.M. (2013). Red Pidada (*Sonneratia Caseolaris* L.) Leaf Extract and Fraction Activity as Antioxidants. *Proceedings of the National Seminal Chemistry*. East Kalimantan: Mulawarman University.
- [12] Indrayanti, D.M. (2015). Mangrove ecosystem management in Blanakan Bay, Subang Regency, West Java Province. [Essay]. Bogor: IPB.
- [13] Jacob, A.M., Purwaningsih, S., and Rinto. (2011). Anatomy, Bioactive Compounds and Antioxidant Activity of Mangrove Api-api (*Avicennia marina*) Leaf. *Jurnal Pengolahan Hasil Perikanan Indonesia*. XIV(2). Page. 143-152.
- [14] Kadarisman, I. (2000). Isolation and identification of bioactive chemical compounds from bangle rhizome (*Zingiber cassumunar* Roxb.). [Essay]. Bogor: Bogor Agricultural University.
- [15] Khasanah, N., Rastuti, U., and Handayani, N.S. (2012). Phytochemical Test of *Rizophora mucronata* Fruit Peel. *National Seminar on Chemistry and Chemistry Education IV*. Surakarta : Surakarta State University.
- [16] Lestari, M.A. (2017). Isolation of pedada leaf (*Sonneratia caseolaris* L.) against cervical cancer cells. [Essay]. Makassar: UIN Alauddin.
- [17] Mile, L., Nursyam, H., Setijawati, D., and Sulistiyati, T.D. (2021). Phytochemical Study of Mangrove Fruit (*Rhizophora mucronata*)

- in Langge Village, North Gorontalo Regency. *Jambura Fish Processing Journal*. 3(1). Pages. 1-8. DOI: <https://doi.org/10.37905/jfpj.v3i1.8585>.
- [18] Niken, Putri, I.L.E., Gusti, F.R. (2019). PHYTOCHEMISTRY COMPOUND TEST FROM RED SPRING (*Sonneratia caseolaris*) IN THE AREA OF FORESTRY MANGROVE MANGGUANG PARIAMAN CITY. *Jurnal Kesehatan Saintika Meditory*. 1(2). Page. 44-49.
- [19] Novianty, R, Sastrawibawa, & S, Prihadi, J.D. (2011). Identification of damage and efforts to rehabilitate mangrove ecosystems on the North Coast of Subang Regency. *Journal of Aquatics.*, 2 (2).
- [20] Nur, R.M., Eso, N., Rorano, M., and Suaibun, I. (2019). Identification of Groups of Bioactive Compounds *Rhizophora* sp. In the waters of Morotai Island. *Agricola Journal*. 9(2).Page. 44-48.
- [21] Puspitasari, D. (2017). Antibacterial Activity of *Excoecaria agallocha* Mangrove Sap Extract in Chloroform Solvent against *Escherichia coli* and *Staphylococcus aureus*. *Aquatic Science Journal*, 4(1):1-3.
- [22] Putri, V.S.W., Yulita, V., and Rijai, L.(2015). ANTIOXIDANT ACTIVITY OF RED PIDADA SKIN (*SONNERATIA CASEOLARIS* L.). *Journal of Science and Health*. 1(2). Page. 69-74.
- [23] Ridlo, A., Supriyantini, E., and Sedjati, S. (2019). Total Phenolic Content in *Rhizophora* sp Extract from Teluk Awur, Jepara. *Tropical Marine Journal*. 22(1). Pages. 27-34.
- [24] Santoso, J., Febrianti, F., and Nurjanah. (2010). Phenol content, Phytochemical composition and Antioxidant Activity of The Pedada Fruits *Sonneratia caseolaris*. *Journal of Food Science and Technology*. 8(2). Page. 1-10.
- [25] Sari, K.D. (2008). Screening of Antibacterial and Topoisomerase I Inhibitors from *Xylocarpus granatum*. [Thesis]. Bogor: Bogor Agricultural University.

- [26] Sarno, Marisa, H, & Sa'diah, S. (2013). Several types of mangroves, traditional medicinal plants in Sembilang National Park, Banyuasin, South Sumatra. *Journal of Science Research.*, 16(3):92-98.
- [27] Simanjuntak, M. (2008). Extraction and Fractionation of Leaves Extract Components of the Sensaat Plant (*Melastoma malabathricum*. L) and Testing the Effect of Cream on Burn Healing. [Essay]. Medan: University of North Sumatra.
- [28] Sumardjo & Damin. (2006). Introduction to medical chemistry. pp. 438-450.
- [29] Supriyanto, Indriyanto, & Bintoro, A. (2014). Inventory of medicinal plant species in the mangrove forest of Margasari Village, Labuhan Maringgai District, East Lampung. *Journal of Sylva Lestari.*, 2 (1): 67-76.
- [30] Sutisna, I. (2000). Isolation and characterization of triterpenoid lanostana from danglo bark (*Macaranga javanica* Muell. Arg).[Thesis]. Bogor: Bogor Agricultural University.
- [31] Suwardi, Tambaru, E., Ambeng, Priosambodo, D. (2013). Diversity of Mangrove Species on Panikiang Island, Barru Regency, South Sulawesi. Makassar: Hasanuddin University.

THE COMPARISON OF THE POPULATION OF PLAIN AND MIXED COLORED CATS IN JAKARTA AND PONTIANAK

Khintan Desiranti¹, Vera Veronica², Diki³, Soraya Habibi⁴

*¹Biology Study Program, Faculty of Science and Technology,
Universitas Terbuka (INDONESIA)
030647517@ecampus.ut.ac.id*

Abstract

The objective of this research is to analyze the allele frequencies and heterozygosity in domestic cats (*Felis catus*) in Pontianak and Jakarta, as a means to map the varieties of color and pattern in both areas. Morphological traits such as fur color and color patterns are the variables for analysis in this study. According to previous studies, color patterns of domestic cats are solid color, bicolor, tricolor, pointed, tortoiseshell, white spotting, tipped fur, shaded fur, smoked fur, ticked fur, and tabby. The research is conducted with a quantitative approach, where samples are collected through a road sampling method. A total of 91 samples are collected, comprising 38 individual cats in Jakarta and 53 in Pontianak. Based on the color identification of the samples, the domestic cats with combined patterns are more dominant than a solid color. The most abundant coat color in Jakarta is calico (21%), followed by bicolor (18,42%). The most abundant coat color in Pontianak is bicolor (35,85%), followed by tortoiseshell (13,21%) and ticked tabby (13,21%).

Keywords: domestic cat, population, morphogenetic, color pattern

1 INTRODUCTION

Domestic cats (*Felis catus*), generally labeled as house cats, were estimated to be domesticated in ancient Egypt (Faure & Kitchener, 2009). The mammal belongs to a Felidae family, and its lineage is traced back to *Felis silvestris* which was estimated to exist 35 million years ago (Johnson & O'Brien, 1997; O'Brien et al., 2008). However,

an alternative study in morphometric observation showed the alloenzymes variations in house cats might propose the possibility that *Felis lybica* has a more prominent kinship to *Felis catus* (Randi & Ragni, 1991).

There are different coat color patterns of cats such as *solid*, *bicolor*, *tricolor*, *pointed*, *tortoiseshell*, *white spotting*, *tipped fur*, *shaded fur*, *smoked fur*, *ticked fur*, *tipped fur*, and *tabby* patterns (Dorling Kindersley, 2014). Those color patterns are influenced by different genes (Wright & Walters, 1980).

A study by Lesmana (2008) showed that B-b-b alleles have the highest frequency. The study was conducted in Jakarta. There hasn't been any official study regarding cat's color pattern in Pontianak previously. The refore research is required in order to map and understand the genetic factors that determine coat color and patterns to compare the frequencies and heterozygosity in Jakarta and Pontianak.

In this study, there are two problem formulations, namely: 1. what is the composition of cat colors and patterns in Jakarta and Pontianak? 2. What are the allele frequencies of various cat colors and patterns in Jakarta and Pontianak? The purposes of the study are to study the allele frequency and heterozygosity of cat color genes in Pontianak and Jakarta and to study to what extent the difference of allele frequency in genes that determine cat color in Pontianak and Jakarta.

There are three groups of genes that control the appearance of a cat's coat, which consists of: genes that control color, another group is genes that control color pattern, and the third group consists of genes that control color expression.

The genes that control colors are:

- Locus *B~b~b1* that determines the color Black.
- Locus *O~o* that determines the color Orange (Red).
- Locus *D~d* that determines full pigmentation.

The genes that control color patterns are:

- Locus $C\sim cb\sim cs\sim ca\sim c$ that determines albinism.
- Locus $A\sim a$ that determines agouti.
- Locus $T\sim T_a\sim t_b$ that determines the tabby pattern.

The genes that control color expressions are:

- Locus $W\sim w$ that determines the dominant white color expressions.
- Locus $I\sim i$ determines the inhibitor genes.
- Locus $S\sim s$ that determine the white spotting expressions.

Locus T is responsible for the mackerel tabby. T is dominant toward t_a and t_b . t_a is responsible for Abyssinian tabby, while t_b is responsible for classic tabby. Knolin (2012) analyzed O , a , t_b , d , and S genes which concluded that gene O was less frequent in different regions in Russia, meanwhile in Budapest, Samarra, and Novosibirsk the frequencies of the t_b gene that determines the classic (marbled) coat color pattern were less abundant.

2 METHODOLOGY

The method used in collecting samples is road sampling, in which observers take photographic evidence of individual cats in an area. Photographic evidence is taken by mobile phone cameras. Observers are to sweep around the area thoroughly but are restricted from visiting the same area twice to avoid double sampling.

Each sample taken is to be classified to different color and pattern categories. The color and pattern expressions then are translated to genetic arrangement for deeper and further analysis.

I. Sample Requirements:

Requirements for the samples are such as domestic cat inhabiting areas in Jakarta and Pontianak. Individual samples should be adult cats. Kittens are considered invalid data due to under developing color and pattern expressions.

II. Location and Time of Sampling:

Location of samples collection are Jakarta and Pontianak, including urban and suburban areas. The sampling collection has started since July 2021 and still on going to this date.

III. Data Analysis Method:

The data processing and analysis is using quantitative methods in which populations are categorized into different color and pattern categories to analyze the frequency of each color and pattern. Concluded data in each area are to be compared in order to analyze the difference between each area.

3 RESULTS

The results of research conducted in the areas of Jakarta and Pontianak were 91 cats which were the total sample. The sample data obtained were then analyzed using the road sampling method listed in table 1 and table 2.

Table 1. Sample count table.

Area	Pattern count									Total
	Solid		Party color			Tabby				
	Solid	Tipped	Bicolor	Tortoise shell	Calico	Spotted	Mackerel	classic	Ticked	
JKT	4	0	7	4	8	3	3	3	6	38
PTK	3	1	19	7	5	5	6	0	7	53

Table 2. Sample count table with percentage (%).

Area	Pattern count								
	Solid		Party color			Tabby			
	Solid	Tipped	Bicolor	Tortoise shell	Calico	Spotted	Mackerel	classic	Ticked
JKT	10,53	0	18,42	10,53	21,05	7,89	7,89	7,89	15,79
PTK	5,66	1,89	35,85	13,21	9,43	9,43	11,32	0	13,21

From the results obtained, there are many color patterns on the cat's body found in Jakarta and Pontianak. A total of 38 samples in Jakarta include 4 solid, 7 bicolor, 4 tortoiseshell, 8 calico, 3 spotted, 3 mackerel, 3 classic, and 6 ticked. There are also 53 in Pontianak including 3 solid, 1 tipped, 19 bicolor, 7 tortoiseshell, 5 calico, 5 spotted, 6 mackerel, and 7 ticked. The data is then processed into a graphical display shown in Figure 1.

Comparison of Sample Counts Based on Color Pattern Categories

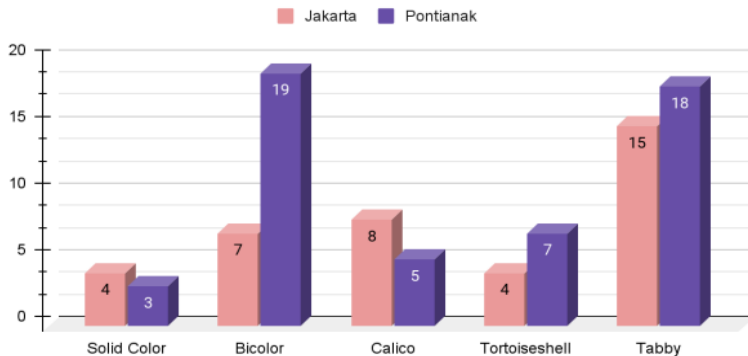

Figure 1. Sample calculation result chart

Based on Figure 1, we can see that there are 19 more bicolors in Pontianak, followed by 18 tabbies. In Jakarta, the highest number of samples was found in tabby species, which were 15 individuals, followed by calico species as many as 8 individuals.

4 CONCLUSIONS

The most abundant coal color in Jakarta is calico (21%), followed by bicolor (18,42%). The most abundant coal color in Pontianak is bicolor (35,85%), followed by tortoiseshell (13,21%) and ticked tabby (13,21%). This shows that there is a mix of colors in the two regions.

ACKNOWLEDGEMENTS

We would like to thank our supervisors who have guided us as writers in conducting this research. The authors apologize that this research is still far from perfect.

REFERENCES

- [1] Aditya, N. (2006). *Keragaman Kucing (Felis domesticus) di Kecamatan Bogor Tengah Berdasarkan Karakter Morfologi*. Bogor: Fakultas Matematika dan Ilmu Pengetahuan Alam. Institut Pertanian Bogor.
- [2] Dorling Kindersley. (2014). *The Cat Encyclopedia: The Definitive Visual Guide*. Dorling Kindersley' Publishing.
- [3] Lesmana, T. (2008). *Morfogenetik Kucing (Felis domesticus) di Jakarta Timur*. (Skripsi). Departemen Biologi Fakultas Matematika dan Ilmu Alam Institut Pertanian Bogor.
- [4] Shostell, J. M., Staudinger, J., & Ruiz-Garcia, M. (2005). *Mutant allele frequencies in domestic cat populations in Arkansas and Tennessee*. *Journal of Heredity*, 96(5), 557-565.
- [5] Wright, Michael., and Sally Walters. (1980). *The Book of The Cat*. Pan Books Publishing.

ARRANGEMENT OF SLUM SETTLEMENT AREAS IN KAMPUNG UTAN PANJANG INTO A LIVEABLE CITY WITH A LAND-READJUSTMENT APPROACH

PENATAAN PERMUKIMAN KUMUH DI KAMPUNG UTAN PANJANG MENJADI KAWASAN LAYAK HUNI DENGAN PENDEKATAN LAND-READJUSTMENT

**Nandia Nurhasanah¹, Aysfan Nandha Yulianti², Zahra Aulia
Syuhada³, Raymond Leonard⁴, Inneke Agustin⁵,
Muhammad Alif Leksono⁶, Achmad Nuzulul Furqan⁷, Didi
Indrawan⁸, Ake Wihadanto⁹, Erika Pradana Putri¹⁰, Ulul
Hidayah¹¹**

*Perencanaan Wilayah dan Kota, Fakultas Sains dan Teknologi,
Universitas Terbuka, (INDONESIA)
030102248@ecampus.ut.ac.id*

Abstract

Most cities in Indonesia are found in slum areas that grow sporadically and unplanned. One of the settlements in the city of Jakarta is RW 10 Kampung Utan Panjang which is located in Kemayoran District. RW 10 Kampung Utan Panjang is divided into 13 RTs which have an area of 3.56 hectares with a population of 3,681 people and 650 families. The slums in this area are indicated by the poor physical condition of the environment such as the density of buildings and irregularities in the building and the lack of availability of public infrastructure to meet the needs of the community. The purpose of this settlement is to formulate a scenario for structuring slums with a land readjustment approach. The stages in this study are (1) analyzing the characteristics of slum settlements in RW 10 Kampung Utan Panjang, (2) analyzing the level of slums using scoring analysis techniques. And (3) formulating directions for structuring slums with a land readjustment approach. The results of this study, the value of the slum level of RW

10 Kampung Utan Panjang is 86 which is classified as a heavy slum. With this level of slums, RW 10 Kampung Utan Panjang needs to be transformed to improve the quality of the area's environment and people's lives. Furthermore, the arrangement is directed at the development of vertical housing with efforts to improve the physical and living quality of the local community. With the contribution of land from the community, the need for public facilities will be fulfilled and allow for green open space and reserve land.

Keywords: Land Readjustment. Urban Villages, Slums

Abstrak

Sebagian besar kota-kota di Indonesia banyak ditemui kawasan permukiman kumuh yang tumbuh secara sporadis dan tidak terencana. Salah satu permukiman di Kota Jakarta adalah RW 10 Kampung Utan Panjang yang berada di Kecamatan Kemayoran. RW 10 Kampung Utan Panjang terbagi 13 RT yang memiliki luas 3,56 Ha dengan jumlah penduduk sebanyak 3.681 jiwa dan 650 KK. Kekumuhan pada kawasan ini ditunjukkan dengan kondisi fisik lingkungan yang buruk seperti kepadatan bangunan dan ketidakteraturan bangunan serta masih kurangnya ketersediaan sarana prasarana umum untuk memenuhi kebutuhan masyarakat. Tujuan dari permukiman ini adalah merumuskan skenario penataan permukiman kumuh dengan pendekatan *land readjustment*. Tahapan pada penelitian ini yaitu (1) menganalisis karaktersitik permukiman kumuh RW 10 Kampung Utan Panjang, (2) menganalisis tingkat kekumuhan dengan teknik analisis skoring. Dan (3) merumuskan arahan penataan permukiman kumuh dengan pendekatan *land readjustment*. Hasil dari penelitian ini, nilai tingkat kekumuhan RW 10 Kampung Utan Panjang yaitu 86 yang termasuk kumuh berat. Dengan tingkat kekumuhan tersebut, RW 10 Kampung Utan Panjang perlu dilakukan transformasi untuk meningkatkan kualitas lingkungan kawasan dan hidup masyarakat. Selanjutnya penataan diarahkan pada pengembangan hunian vertikal dengan upaya meningkatkan kualitas fisik dan hidup masyarakat setempat. Dengan kontribusi

lahan dari masyarakat, akan terpenuhinya kebutuhan sarana umum dan memungkinkan adanya ruang terbuka hijau dan lahan cadangan. Kata kunci: Land Readjustment. Kampung Kota, Permukiman Kumuh

1 PENDAHULUAN

Permukiman kumuh masih menjadi salah satu permasalahan yang harus segera diselesaikan oleh Pemerintah Provinsi DKI Jakarta. Hal ini tentunya membutuhkan perhatian yang sangat serius dari pemerintah dan kesadaran dari masyarakat sendiri. Berdasarkan data dari Kementerian ATR/BPN pada Mei 2019, permukiman kumuh di DKI Jakarta tersebar di 118 dari 267 kelurahan atau sekitar 45% dari total seluruh luas kelurahan. Luas permukiman kumuh mencapai 1.005,24 Ha dengan sebaran wilayah di Jakarta Utara 30%, Jakarta Barat 28%, Jakarta Selatan 18%, Jakarta Timur 12%, Jakarta Pusat 11% dan Kepulauan Seribu 1%. Jakarta Pusat sebagai kota dengan jumlah penduduk terpadat di ibukota Jakarta, merujuk pada data BPS yaitu sekitar 19.351 jiwa/km². Kepadatan ini didukung oleh banyaknya permukiman kumuh sebesar 11% di kawasan Jakarta Pusat. Permukiman kumuh Jakarta Pusat tersebar di beberapa titik seperti daerah Senen, Kemayoran dan Johar Baru. Kemayoran merupakan kawasan padat penduduk kedua di Jakarta Pusat dan memiliki sebaran permukiman kumuh di 3 titik lokasi yaitu Kampung Harapan Mulya, Kampung Utan Panjang, dan Kampung Kebon Kosong. Ada 98 RW kumuh di Jakarta Pusat dan 38 RW diantaranya menjadi prioritas untuk segera dilakukan penataan permukiman.

Permukiman kumuh adalah permukiman yang tidak layak huni karena ketidakteraturan bangunan, tingkat kepadatan bangunan yang tinggi, dan kualitas bangunan serta sarana dan prasarana yang tidak memenuhi syarat. Perumahan kumuh adalah perumahan yang mengalami penurunan kualitas fungsi sebagai tempat hunian (Undang-Undang Nomor 1 Tahun 2011 tentang Perumahan dan Kawasan Permukiman). Tinjauan mengenai permukiman kumuh pada umumnya dilihat dari tiga sisi, yaitu, pertama, aspek kondisi fisik yang mencakup kerapatan bangunan dengan kualitas konstruksi yang

rendah, sanitasi umum dan saluran drainase yang kurang atau tidak berfungsi dengan baik, jaringan jalan yang tidak berpola, serta pengelolaan sampah yang kurang baik. Kedua, aspek sosial-ekonomi-budaya masyarakat yang menghuni permukiman kumuh mencakup tingkat pendapatan yang rendah, kemiskinan yang membudaya yang terlihat dari sikap dan perilaku masyarakat yang terbiasa dengan kekumuhan, dan norma sosial yang longgar. Ketiga, dampak dari kondisi kedua sisi tersebut yaitu permukiman kumuh sebagai sumber pencemaran, sumber penyebaran penyakit yang berimplikasi pada kondisi kesehatan masyarakat yang buruk, dan perilaku sosial yang menyimpang.

Salah satu kawasan permukiman kumuh yang penataannya diprioritaskan adalah RW 10 Kampung Utan Panjang di Kemayoran yang tergolong tingkat kumuh sedang atau termasuk dalam Kawasan Permukiman Kumuh Luas <10 Ha, yang diapit oleh dua sungai yaitu Kali Baru Timur di sisi barat dan Kali Sentiong di sisi timur. Pola kependudukan di RW 10 Kampung Utan Panjang telah terbentuk secara turun-temurun. RW 10 memiliki luas 3,56 ha dengan jumlah penduduk sebanyak 3.681 jiwa yang terdiri dari 650 KK. Berdasarkan luas wilayah dan jumlah penduduk, tingkat kepadatan penduduk rata-rata sebesar 1.033,98 jiwa/ha. Jumlah bangunan rumah yang terdapat di RW 10 berjumlah 495 bangunan dengan tingkat kepadatan bangunan rata-rata sebesar 139,6 bangunan/ha. Penggunaan lahan di kawasan ini didominasi oleh kawasan permukiman dan terdapat kawasan perdagangan dan jasa di sisi timur, tepatnya di pinggir Jalan Utan Panjang. Permasalahan yang paling terlihat di RW 10, khususnya pada kondisi spasial yaitu bangunan rumah tidak tertata dan tidak terkendali atau tumbuh tanpa perencanaan. Kumuhnya permukiman di RW 10 Kampung Utan Panjang akibat dari aktivitas yang terlalu berlebihan, sehingga menyebabkan lingkungan hunian tidak sehat, tidak nyaman dan tidak layak untuk ditinggali.

Untuk mencegah berkembangnya tingkat kekumuhan kota, maka perlu dilakukan penataan kawasan di RW 10 Kampung Utan Panjang. Penataan dibutuhkan untuk mencapai kota tanpa kumuh yaitu

perubahan dari *slum upgrading* ke *slum alleviation*, atau yang dari awalnya hanya mengatasi persoalan eksisting melalui penyediaan infrastruktur menjadi terfokus pada penataan permukiman kumuh eksisting sekaligus mencegah terbentuknya permukiman kumuh baru. Penataan permukiman kumuh di RW 10 Kampung Utan Panjang dapat dikaitkan dengan peremajaan permukiman yang bertujuan untuk melakukan perubahan fisik kawasan melalui perencanaan fisik atau sarana prasarana, seperti jaringan jalan, drainase, air bersih, sanitasi, pengelolaan sampah dan pembangunan perumahan yang layak huni untuk masyarakat. Penyelenggaraan permukiman layak huni tersebut memiliki tujuan untuk memenuhi hak warga negara atas tempat tinggal yang layak dalam lingkungan yang sehat, serasi, aman dan teratur serta menjamin kepastian bermukim, yang wajib dilaksanakan sesuai dengan arahan pengembangan kawasan permukiman yang terpadu dan berkelanjutan. Hal ini ditandai oleh terpenuhinya kebutuhan hunian yang dilengkapi dengan sarana dan prasarana pendukungnya bagi seluruh masyarakat yang didukung oleh sistem pembiayaan perumahan jangka panjang dan berkelanjutan, efisien, dan akuntabel untuk mewujudkan kota tanpa permukiman kumuh (SDG's Goals Target 6: Clean Water and Sanitation and Target 11: Sustainable Cities and Communities).

Berdasarkan latarbelakang diatas, maka perumusan masalah yang diambil pada penelitian ini adalah **“Bagaimana melakukan penataan pada kampung kumuh menjadi kawasan layak huni dengan pendekatan metode land readjustment di RW 10 Kampung Utan Panjang?”**. Adapun tujuan dari penataan permukiman kumuh di RW 10 Kampung Utan Panjang adalah sebagai upaya untuk merumuskan arahan yang tepat dan efisien terkait penataan permukiman kumuh RW 10 Kampung Utan Panjang. Secara lebih spesifik penelitian ini mencakup (1) mengidentifikasi dan menganalisis tingkat kekumuhan RW 10 Kampung Utan Panjang, (2) merumuskan konsep penataan, (3) menyusun desain penataan ulang blok kawasan. Hasil analisis ini diharapkan dapat menjadi solusi untuk penataan dan kampung kumuh menjadi kawasan yang layak huni.

2 METODOLOGI

Data yang digunakan dalam penelitian ini meliputi data primer dan data sekunder. Pengambilan data dilakukan pada Mei-Juni 2021. Metode yang digunakan dalam pengumpulan data primer yaitu metode wawancara, metode observasi dan metode dokumentasi. Data Primer dikumpulkan dengan tahapan sebagai berikut:

1. Survei pendahuluan untuk mengidentifikasi karakteristik kondisi eksisting RW 10 Kampung Utan Panjang yang menjadi wilayah perencanaan penyesuaian ulang lahan kampung kumuh. Survei menggunakan peta dasar hasil digitasi berdasarkan tata letak persil bangunan yang tidak teratur dan mengetahui jumlah bangunan aktual dengan citra satellite resolusi tinggi ortofoto yang terektifikasi akuisisi. Berdasarkan hasil digitasi tersebut diperoleh data dan informasi jumlah persil bangunan yaitu 495 bangunan.
2. Responden dalam penelitian ini ditentukan dengan teknik purposive sampling yaitu pengurus RW 10 dan RT setempat. Sensus menggunakan metode wawancara terhadap responden untuk memperoleh data dan informasi mengenai kependudukan, kondisi karakteristik fisik dan lingkungan bangunan, sarana prasarana dan kepemilikan lahan.
3. Observasi dan dokumentasi untuk mengetahui data dan informasi mengenai tingkah laku nonverbal yang terjadi di RW 10 Kampung Utan Panjang, seperti kondisi sosial masyarakat setempat yang kemudian diabadikan melalui foto atau video.

Selain itu, penelitian ini menggunakan data sekunder yaitu Laporan Kelurahan Utan Panjang Bulan Februari 2021, data kolektif dari SIG JakartaSatu terkait batas administrasi, jaringan jalan, dan penggunaan lahan eksisting. Peralatan yang digunakan dalam penelitian ini meliputi perangkat lunak pengolah data dan kata, perangkat lunak pengolah angka, dan perangkat lunak pengolah data spasial.



Gambar 1. Delineasi Kawasan Kumuh RW 10 Utan Panjang

Dalam penelitian ini, analisis dilakukan dengan pendekatan kualitatif dan kuantitatif. Analisis karakteristik kawasan dilakukan dengan pendekatan deskriptif kualitatif, yang mempertimbangkan aspek-aspek dari karakteristik penghuni, karakteristik hunian, karakteristik sarana prasarana dan karakteristik spasial. Analisis ini dilakukan dengan teknik analisis deskriptif kualitatif yang dijabarkan melalui narasi, tabel dan gambar. Analisis tingkat kekumuhan dilakukan dengan mengukur tingkat kemampuan tingkat kekumuhan suatu kawasan permukiman menggunakan kriteria atau indikator tertentu. Dalam penelitian ini, pengukuran tingkat kekumuhan dilakukan dengan metode yang dirumuskan dalam Permen PUPR No. 2 02/PRT/M/2016 tentang Peningkatan Kualitas Terhadap Perumahan dan Permukiman Kumuh. Kriteria atau indikator yang dipertimbangkan dalam penilaian kawasan kumuh adalah kriteria bangunan gedung jalan lingkungan, penyediaan air bersih dan minum, drainase lingkungan, pengelolaan air limbah, pengelolaan

persampahan dan pengaman kebakaran. Identifikasi kekumuhan dilakukan dengan cara memberikan skor pada kriteria-kriteria berdasarkan skala penilaian yang mempengaruhi kawasan permukiman kumuh dari setiap indikator. Kemudian dilakukan analisis hingga menghasilkan klasifikasi tingkat kawasan kumuh di RW 10. Berikut ini merupakan kriteria-kriteria pada setiap indikator kawasan kumuh.

Tabel 1. Kriteria-Kriteria Indikator Kawasan Kumuh

Aspek	Kriteria
Kondisi bangunan	<ol style="list-style-type: none"> 1. Ketidakteraturan bangunan 2. Tingkat kepadatan bangunan 3. Ketidaksesuaian dengan persyaratan teknis bangunan
Kondisi jalan lingkungan	<ol style="list-style-type: none"> 1. Cakupan pelayanan jalan lingkungan 2. Kualitas permukaan jalan lingkungan
Kondisi penyediaan air minum	Ketidaktersediaan akses aman air minum
Kondisi drainase lingkungan	<ol style="list-style-type: none"> 1. Ketidakterhubungan dengan sistem drainase perkotaan 2. Tidak terpeliharanya drainase 3. Kualitas konstruksi drainase 4. Ketidakmampuan mengalirkan limpasan air
Kondisi pengelolaan air limbah	<ol style="list-style-type: none"> 1. Sistem pengelolaan air limbah tidak sesuai dengan standar teknis 2. Sarana dan prasarana pengelolaan air limbah tidak sesuai dengan standar teknis
Kondisi pengelolaan persampahan	<ol style="list-style-type: none"> 1. Sarana dan prasarana persampahan tidak sesuai dengan standar teknis 2. Sistem pengelolaan persampahan tidak sesuai dengan standar teknis 3. Tidak terpeliharanya sarana dan prasarana
Kondisi proteksi kebakaran	<ol style="list-style-type: none"> 1. Ketidaktersediaan prasarana proteksi kebakaran 2. Ketidaktersediaan sarana proteksi kebakaran

Penilaian terhadap masing-masing aspek dilakukan berdasarkan kondisi di lapangan, kemudian disesuaikan dengan kriteria dan indikatornya untuk diberi nilai. Masing-masing parameter mempunyai bobot nilai 1 (26-50%), bobot nilai 3 (51-75%), dan bobot nilai 5 (76-100%), yang selanjutnya ditotal untuk menentukan nilai kekumuhan. Kriteria yang digunakan untuk menentukan kondisi kekumuhan sebagai berikut: (1) kumuh berat jika memiliki nilai total 71-97, (2) kumuh sedang jika memiliki nilai total 45-70, dan (3) kumuh ringan jika memiliki nilai total 19-44.

3. HASIL DAN PEMBAHASAN

3.1 Karakteristik Permukiman

3.1.1 Aspek Fisik Lingkungan dan Hunian

Kondisi fisik lingkungan secara keseluruhan dipengaruhi oleh karakteristik huniannya. RW 10 Kampung Utan Panjang mempunyai tingkat kepadatan bangunan yang tinggi dengan jarak bangunan saling berdekatan, kondisi ini menyebabkan tata bangunan menjadi tidak teratur dan semrawut. Kerapatan bangunan yang tinggi mengganggu intensitas cahaya dan sirkulasi udara. Jalan lingkungan atau gang yang lebarnya hanya 0,5–1,5 m. Sebagian besar bangunan di kawasan tersebut memiliki luas dibawah 45 m² dan rata-rata setiap bangunan dihuni oleh sekitar 10 orang atau 2-3 kepala keluarga. Banyak ditemui di lokasi penelitian kondisi bangunan sudah permanen, mayoritas rumah-rumah di kawasan ini beratapkan asbes karena dinilai harganya lebih murah daripada genteng. Untuk dinding bangunan, mayoritas memakai bahan material semen/beton untuk lantai 1, sedangkan bahan material triplek dan campuran semen digunakan untuk lantai 2 atau 3. Lantai bangunan sudah banyak yang menggunakan bahan material keramik dan ubin.

Banyaknya luas bangunan yang kurang dari 36 m² mempengaruhi penggunaan ruang dalam rumah hunian. Dilihat dari luas dan banyak kamar yang ada tidak sebanding dengan jumlah penghuni. Kondisi ini dinilai tidak memadai untuk mendukung aktivitas dasar masyarakat, seperti penggunaan ruang tamu dan kamar tidur yang biasanya

disatukan, sedangkan dapur berada di luar bangunan rumah dan berada jalan gang. Terjadi aktivitas yang berlebihan dan kurang sesuai di jalan gang, karena penggunaan jalan tidak lagi dipandang sebagai aksesibilitas masyarakat tetapi juga digunakan untuk menunjang kebutuhan ruang dalam hunian yang tidak cukup.

Tabel 2. Karakteristik Fisik Lingkungan dan Hunian

Karakteristik	Kondisi Aktual
Luas Bangunan	90% bangunan memiliki luas kurang dari 45 m ²
Penghuni bangunan	Dihuni sekitar 10 orang atau 2-3 KK
Koefisien Dasar Bangunan (KDB)	Lebih dari 80%
Koefisien Lantai Bangunan (KLB)	80% bangunan memiliki 2-3 lantai
Jumlah persil bangunan	495 persil bangunan
Kepadatan bangunan/m ²	0,01 unit bangunan/m ²
Jarak antar bangunan	0 – 0,6 meter
Kondisi fisik bangunan	Baik 30%, Sedang 60%, Rusak 10%
Bentuk fisik bangunan	Permanen 70%, Semi Permanen 30%
Status kepemilikan tanah	Bersertifikat 95%, Belum bersertifikat 5%
Status kepemilikan bangunan	Milik Sendiri 75%, Kontrak/Kost = 25%

Dari sisi status kepemilikan tanah, dari total persil bangunan yang ada yaitu 495 bangunan, sebesar 95% tanah merupakan tanah bersertifikat hak milik. Sedangkan sisanya yaitu 5% merupakan tanah yang masih dalam proses sertifikasi. Kemudian dalam hal kepemilikan bangunan, masyarakat mengklaim sebagai pemilik bangunan meskipun tidak memiliki Izin Mendirikan Bangunan atau IMB karena bangunan hunian masyarakat setempat telah dihuni secara turun temurun selama puluhan tahun. Berdasarkan karakteristik fisik lingkungan dan hunian, RW 10 Kampung Utan Panjang dapat dikategorikan *slum area*, yang merupakan kawasan kumuh tetapi diakui sebagai kawasan permukiman.

3.1.2 Aspek Sarana dan Prasarana

Sarana dan prasarana sebagai penunjang aktivitas masyarakat di RW 10 Kampung Utan Panjang seperti jalan, drainase, sanitasi, akses air bersih, dan persampahan sudah tersedia namun kondisinya kurang memadai. Untuk pemenuhan kebutuhan air bersih, masyarakat setempat menggunakan air bersih dari PDAM dan sumur komunal. Air bersih tersebut digunakan untuk kebutuhan sehari-hari, seperti mencuci dan memasak, sedangkan untuk kegiatan mandi dan kakus masih banyak masyarakat yang memanfaatkan MCK umum. MCK Umum yang ada di RW 10 Kampung Utan Panjang memiliki luas sekitar 135x65x200 cm dengan 2-3 bilik. Penggunaan MCK umum dikatakan cukup tinggi dengan kondisi MCK umum yang buruk. Keberadaan MCK umum saat ini, dirasa masih kurang mencukupi kebutuhan penggunaan. Pembuangan limbah MCK umum biasanya langsung dibuang ke selokan yang nantinya mengalir ke sungai-sungai sekitar, namun ada juga MCK umum yang sudah difasilitasi oleh septic tank biopal tipe 2 yang berada di RT 08 yang merupakan bantuan dari PDAM DKI Jakarta. Selain itu, terdapat sekitar 60% masyarakat yang memiliki WC pribadi, namun untuk pembuangan limbahnya tidak semua memiliki septic tank.



Gambar 3. Sarana dan Prasarana Umum di RW 10 Utan Panjang

RW 10 Kampung Utan Panjang tidak memiliki tempat sampah komunal. Dalam pengelolaan sampah, masyarakat memberikan iuran sampah setiap harinya sebesar Rp.2.000 untuk sampah rumah tangga, dan Rp.5.000 untuk sampah rumah dengan usaha seperti warung atau toko. Sistem pembuangan sampah di kawasan ini berupa pengangkutan sampah yang dilakukan setiap hari dengan menggunakan truk sampah.

Tabel 3. Karakteristik Sarana dan Prasarana

Karakteristik	Kondisi Aktual
Sumber air bersih	Sumur komunal (air tanah) dan PDAM
Limbah rumah tangga	Tidak memiliki pengelolaan limbah rumah tangga dan limbah dibuang ke selokan yang mengalir ke sungai
Drainase	Drainase buruk, banyak sampah
Sanitasi	WC Pribadi 60%, MCK Umum 40%
Kondisi MCK Umum	Tidak terawat dan kualitasnya buruk
Keberadaan tempat pembuangan sampah	Tidak terdapat tempat pembuangan sampah komunal
Jalan	Lebar 0,5 – 1,5 m
Kualitas jalan	Baik

Setiap sore hari akan ada petugas yang mengangkut sampah rumah tangga masyarakat. Ketidakterediaan tempat pembuangan sampah komunal sementara, membuat kebiasaan masyarakat di kawasan ini membuang limbah di selokan yang menyebabkan saluran drainase mengalami penurunan kualitas. Banyak ditemukan saluran drainase dalam kondisi rusak, terdapat banyak sampah dan tergenang. Ditemukan banyaknya tumpukan sampah di saluran penghubung dari 2 kali (Kali Sentiong dan Kali Baru Timur). Bantuan pengerukan dan pembersihan sampah di saluran tersebut sudah dilakukan oleh dinas kebersihan setempat, namun kondisi saluran yang berada di bawah rumah hunian membuat sampah sulit dibersihkan. Hal ini menyebabkan banjir terutama di RT 09 setiap tahunnya apabila musim hujan tiba. Ketinggian banjir tiap tahunnya sekitar 30-50 cm. ggn



Gambar 4. Kondisi jalan di RW 10 Utan Panjang

Prasarana jalan di RW 10 Kampung Utan Panjang sudah menggunakan aspal. Jalan ini berupa gang dengan lebar 0,5–1,5 m yang hanya dapat dilalui oleh satu orang, tidak cukup untuk dilalui kendaraan bermotor roda dua. Kondisi gang yang sempit ini menyebabkan kurangnya lahan parkir kendaraan masyarakat setempat. Untuk kebutuhan lahan parkir kendaraan, masyarakat memanfaatkan pinggiran Jalan Kalibaru sebagai lahan parkir. Sistem parkir berdasarkan kesadaran dan kewaspadaan masing-masing pemilik kendaraan, tidak ada pengamanan ataupun penjaga parkir. Keterbatasan lahan di permukiman kumuh membuat masyarakat kurang memperhatikan ketersediaan ruang terbuka di lingkungan perumahan. Selain sebagai daerah resapan air, keberadaan ruang terbuka juga sebagai arena bermain anak dan sarana rekreasi masyarakat. Karena keterbatasan ruang terbuka, anak-anak di RW 10 Kampung Utan Panjang terbiasa bermain di jalanan tanpa memperdulikan kendaraan yang melintas, hal ini jelas sangat membahayakan keselamatan anak-anak.

3.1.3 Aspek Karakteristik Penghuni

Mayoritas penghuni di RW 10 Kampung Utan Panjang merupakan penduduk asli atau keluarga yang sudah menetap secara turun temurun. Jumlah penduduknya sebanyak 3.681 jiwa dengan 650 KK.

Jumlah KK dalam satu rumah akan mempengaruhi nilai kekumuhannya. Hal ini dikarenakan menumpuknya anggota keluarga dalam satu rumah, sehingga kebutuhan ruang dalam rumah semakin tinggi dan pemanfaatan ruang gerak semakin sempit. Ditemui di lokasi penelitian banyak dijumpai 2-3 KK dalam satu rumah dengan luas bangunan kurang dari 45 m². Secara sosial ekonomi, karakteristik penghuni RW 10 Kampung Utan Panjang sebagian besar bekerja pada sektor informal seperti pedagang/wiraswasta dan karyawan swasta, kurir ekspedisi, *driver ojek online*, ataupun petugas keamanan. Sebagian besar masyarakat setempat berpenghasilan sebesar Rp.3.000.000-Rp.5.000.000. Penghasilan tersebut digunakan untuk memenuhi kebutuhan sehari-hari seperti biaya listrik, biaya air PDAM dan biaya pendidikan anak.

Tingkat kerawanan sosial di RW 10 Kampung Utan Panjang termasuk tinggi. Sering terjadi tawuran antar warga, dalam tahun terjadi beberapa kali kasus. Selain itu, sering juga terjadi kasus pencurian barang. Hal ini didorong keterbatasan ekonomi.

Tabel 4. Karakteristik Penghuni

Karakteristik	Kondisi Aktual
Pekerjaan masyarakat	Pedagang 70%, Karyawan Swasta 10%, Buruh 20%
Penghasilan/pendapatan	Rp.3.000.000–Rp.5.000.000
Tingkat pendidikan	>80% lulusan SMA/SMK

3.2 Analisis Tingkat Kekumuhan

Dari hasil analisis tingkat kekumuhan yang telah dilakukan, diperoleh bobot atau nilai tingkat kekumuhan sebesar 86 yang termasuk dalam kategori kumuh berat sesuai dengan rentang nilai diantara 71–95 berdasarkan kriteria kekumuhan. Dilihat dari nilai tingkat kekumuhan RW 10 Kampung Utan Panjang yang tinggi, menunjukkan bahwasannya 9 indikator tersebut hampir sebagian besar mempunyai bobot kualitas yang paling rendah.

Tabel 5. Indikator Tingkat Kekumuhan RW 10 Utan Panjang

No.	Indikator	Kondisi Aktual	Bobot
1.	Ketidakteraturan bangunan	90% bangunan di lokasi tidak teratur	5
2.	Kepadatan bangunan	95% KDB diatas 80%	5
		80% KLB 2-3 lantai	5
3.	Kondisi fisik bangunan	10% bangunan dalam keadaan rusak dan tidak memenuhi syarat	0
4.	Jalan lingkungan	Lebar jalan 0,5-1,5 m beberapa jalan tidak dapat dilalui kendaraan roda dua	5
		90% jalan sudah aspal	0
		60% jalan tergenang saat hujan	5
5.	Ketersediaan air bersih	Masyarakat memiliki akses PDAM dan sumur komunal	1
		95% kebutuhan air bersih terpenuhi	0
6.	Saluran Drainase	80% kawasan tidak memiliki saluran drainase	5
		60% area terjadi genangan setiap tahun	5
		Pemeliharaan drainase tidak rutin dilakukan	5
		70% drainase dalam kondisi rusak	5
		Drainase tidak tersambung dengan sistem drainase perkotaan	5
7.	Pengelolaan limbah	Belum memiliki pengelolaan limbah	5
		Air limbah langsung dialirkan ke sungai	5
8.	Pengelolaan sampah	Tidak semua RT tempat sampah komunal	5
		Sarana pengangkut sampah tidak terpelihara dengan baik	5

No.	Indikator	Kondisi Aktual	Bobot
		Belum tersedia sistem pengelolaan sampah terpadu	5
9.	Proteksi Kebakaran	Prasarana proteksi kebakaran sangat minim, seperti jaringan jalan sempit tidak dapat diakses kendaraan roda empat	5
Total Bobot Tingkat Kekumuhan			86

3.3 Merumuskan Skenario Penataan Permukiman Kumuh dengan Pendekatan *Land-Readjustment*

Arahan penataan permukiman kumuh RW 10 Kampung Utan Panjang dirumuskan berdasarkan hasil kajian Pustaka mengenai konsep *Land-Readjustment*, karakteristik kawasan permukiman kumuh dan hasil penjarangan aspirasi masyarakat mengenai kebutuhan ruang. Dalam merumuskan arahan penataan permukiman kumuh RW 10 Kampung Utan menggunakan analisis deskriptif. Menurut Peraturan Menteri PU, komposisi infrastruktur dan permukiman adalah 60% untuk hunian dan 40% untuk fasilitas umum. Perbandingan persentase tersebut tergantung luas permukiman yang ada. Untuk permukiman skala kecil, lahan untuk fasilitas umum 20-30% dari total lahan. Pembagian lahan dengan pendekatan konsep *land-readjustment* berorientasi pada 60% untuk permukiman, 30% untuk fasilitas umum dan 10% untuk lahan cadangan,

Untuk mentransformasi permukiman kumuh dan padat seperti RW 10 Kampung Utan Panjang dapat dipilih alternatif pembangunan hunian vertikal berupa rumah susun. Dalam *Land-readjustment* memungkinkan terjadinya penggabungan lahan terkhusus untuk menata penggunaan dan kepemilikan persil lahan yang luasnya kecil. Pemilik tanah akan diajak sepakat untuk menyatukan lahan menjadi satu bidang untuk pembangunan hunian vertikal berupa rumah susun dengan sarana umum yang memadai untuk menunjang kehidupan masyarakat setempat. Lahan yang disatukan menjadi beberapa blok kawasan tersebut akan direncanakan di realokasi untuk penggunaan

hunian vertikal, kawasan perdagangan dan jasa atau komersial, fasilitas umum dan sosial, dan ruang terbuka. Dengan membangun hunian vertikal (rumah susun), KDB akan mengecil dan memungkinkan penyediaan ruang terbuka hijau yang cukup sehingga tata ruangnya menjadi lebih nyaman. Pembangunan rumah susun tidak hanya menata fisik lingkungan permukiman kumuh tetapi juga meningkatkan kapasitas hunian dengan menambah luas dan jumlah lantai serta menyediakan hunian yang terjangkau dan layak huni untuk masyarakat berpenghasilan rendah (MBR).

Rencana pembangunan hunian vertikal rumah susun berdasarkan kondisi penggunaan lahan aktual dan ketersediaan luas lahan di RW 10 Kampung Utan Panjang. Secara administrasi, RW 10 Kampung Utan Panjang berada di Kecamatan Kemayoran dan memiliki 13 RT dengan luas 3,56 Ha. Jumlah penduduk yang menghuni kawasan tersebut sekitar 3.681 jiwa dengan tingkat kepadatan penduduk setinggi 0,10 jiwa/m². Secara umum penggunaan lahan aktual di RW 10 Kampung Utan Panjang saat ini terdiri dari permukiman dan pedagangan jasa.

Tabel 6. Penggunaan lahan aktual di RW 10 Utan Panjang

Jenis Penggunaan Lahan	Luas (m ²)
Perdagangan dan Jasa	7.766,90
Permukiman	18.102,04
RTH	2.253,99
Jaringan Jalan	4.049,81
Sungai	3.389,78
Sekretariat RW	81,53
Total Luas Kawasan	35.644

RW 10 Kampung Utan Panjang mempunyai tingkat kekumuhan tinggi yaitu bobot 86. Dengan kondisi demikian, kawasan tersebut memerlukan transformasi untuk mengurangi tingkat kekumuhan dan meningkatkan kualitas kawasan. Analisis kebutuhan ruang berdasarkan jumlah penduduk sebanyak 3.681 di RW 10 Kampung

Utan Panjang dengan asumsi 1 KK berisikan 4 anggota keluarga, sehingga direncanakan untuk dibangun hunian vertikal berupa rumah susun sederhana tipe 36 yang berisikan 1 ruang keluarga, 2 kamar tidur, 1 kamar mandi, dan 1 ruang dapur. Untuk rumah susun sederhana tipe 36 ini maksimal diperuntukkan untuk 4 jiwa per unitnya. Berikut hasil analisis kebutuhan unit tipe 36 di RW 10 Kampung Utan Panjang.

*Tabel 7. Blok dan luasan hasil replotting penyesuaian ulang
RW 10 Utan Panjang*

Rusun	Jumlah Lantai	Unit per Lantai	Total Unit
Rusun 1	8	22	175
Rusun 2	8	25	200
Rusun 3	8	28	225
Rusun 4	10	15	150
Rusun 5	8	32	250
Total Unit			1.000

Desain replotting blok kawasan kumuh RW 10 Kampung Utan Panjang dibagi dalam beberapa blok. Untuk mentransformasi permukiman padat dan kukuh seperti RW 10 Kampung Utan Panjang dapat dipilih alternatif pembangunan hunian vertikal seperti rumah susun. Dalam 1 blok nantinya akan terdapat beberapa penggunaan lahan, seperti permukiman, perdagangan dan jasa, ruang terbuka hijau, dan sarana umum.

*Tabel 8. Ketersediaan lahan per blok setelah replotting
 RW 10 Utan Panjang*

Rencana Blok	Luas (m ²)
Blok 1	3.438
Blok 2	4.117
Blok 3	4.670
Blok 4	2.004
Blok 5	5.105
Jaringan Jalan	9.525
Total	28.859

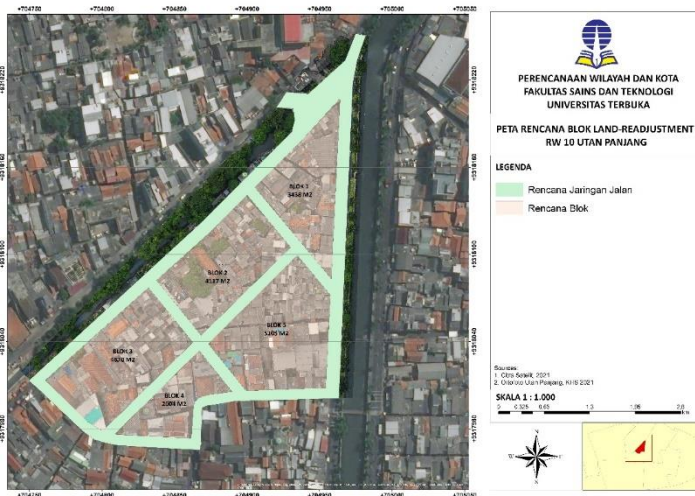

*Gambar 5. Desain Replotting Penyesuaian Lahan
 RW 10 Utan Panjang*

Dilihat dari hasil pengamatan, aktivitas sosial masyarakat dan arah mobilitasnya, masyarakat RW 10 Kampung Utan Panjang lebih banyak melakukan aktivitas di sisi barat yaitu sekitar Jalan Kali Baru Timur. Maka rumah susun diarahkan menghadap ke sungai. Rencana jaringan jalan lokal primer dengan lebar 7,5 meter untuk

mengefisienkan arus mobilitas atau pergerakan serta lebih memudahkan jalur evakuasi dan penanganan jika terjadi bencana.

Arahan yang dirumuskan yaitu penyediaan lahan sarana dan prasarana yang dapat dialokasikan dari sebagian lahan yang sudah dikontribusikan oleh para pemilik lahan. Selain itu, alokasi lahan untuk kebutuhan sarana penunjang kegiatan, seperti perdagangan jasa dan ruang terbuka hijau. Berikut adalah hasil pembagian luas lahan berdasarkan pemenuhan kebutuhan hunian vertikal di RW 10 Kampung Utan Panjang.

Tabel 9. Pembagian lahan setelah proses land-readjustment

Penggunaan Lahan	Luas (m ²)	Rate (%)
Jaringan Jalan	9.525	33,07
Hunian Vertikal	12.053,6	41,76
Masjid, Balai RW, Posyandu	1.500	5,2
RTH Publik	500	1,73
RTH Pribadi	250	0,88
Perdagangan dan Jasa	3.000	10,4
Lahan Cadangan	2.030,4	6,94
Total	28.859	100

4 KESIMPULAN

Berdasarkan hasil penelitian yang telah dilakukan, yaitu: RW 10 Kampung Utan Panjang memiliki karakteristik antara lain, mayoritas masyarakat bekerja di sektor informal dengan penghasilan rata-rata Rp.3.000.000-Rp.5.000.000. Kondisi fisik hunian banyak ditemui kurang dari 36 m² yang dihuni oleh sekitar 10 orang atau 2-3 KK, Kepadatan bangunan tinggi. Sarana dan prasarana umum tersedia namun kondisinya buruk dan tidak memadai, seperti akses jalan, saluran drainase, pembuangan limbah, sanitasi.

Hasil dari analisis tingkat kekumuhan RW 10 Kampung Utan Panjang dengan bobot **86** yang dikategorikan kumuh berat. Arahan

penataan kawasan diarahkan pada pengembangan hunian vertikal. Konsep yang dipilih untuk penataan kawasan kumuh adalah metode land readjustment. Metode ini dapat memperbaiki kualitas fisik lingkungan dan tata letak bangunan yang lebih teratur, tersedianya fasilitas umum yang memadai.

Arahan pembagian lahan yaitu 60% untuk pemilik lahan dan 40% untuk kepentingan umum. Alokasi lahan yang paling signifikan meningkat yaitu jaringan jalan dengan peningkatan pelebaran jalan 7,5 m dengan kategori jalan lokal primer sepanjang 1.270 m², lahan untuk bangunan rumah susun sebesar 12.053,6 m² atau 41,76%.

Perencanaan hunian vertikal berupa rumah susun sederhana direncanakan dengan tipe tipe 36 yang berisikan 1 ruang keluarga, 2 kamar tidur, 1 kamar mandi, dan 1 ruang dapur. Untuk rumah susun sederhana tipe 36 ini maksimal diperuntukkan untuk 4 jiwa per unitnya. Didapatkan 1.000 unit yang nantinya dapat disewakan. Dari hasil pembagian lahan juga didapatkan lahan cadangan seluas 2.030,4 m² atau 6,94% dari total lahan yang nantinya dapat dimanfaatkan untuk dijual atau disewakan.

REFERENSI

- [1] Ardi, A., & Rahmawati, D. (2018). Arahan Penataan Permukiman Kumuh di Kelurahan Kedungcowek Surabaya Menggunakan Konsep Land Readjustment. *Jurnal Teknik ITS Vol. 7, No. 2*.
- [2] Budihardjo, E. (1997). *Tata Ruang Perkotaan*. Bandung.
- [3] Direktorat Pengembangan Kawasan Permukiman. (2016). *Panduan Pendampingan Penyusunan Raperda tentang Pencegahan dan Peningkatan Kualitas Perumahan Kumuh dan Permukiman Kumuh*. Jakarta: Direktorat Jenderal Cipta Karya Kementerian Pekerjaan Umum dan Perumahan Rakyat.
- [4] Ervianto, W. I., & Felasari, S. (2019). Pengelolaan Permukiman Kumuh Berkelanjutan Di Perkotaan. *Jurnal Spektran*, 178-186.
- [5] Kirmanto, D. (2002). Pembangunan Permukiman Berkelanjutan. *Seminar Peduli Banjir "Forest"*.

- [6] M, S. S., FL, S. S., & Marlina, E. (2006). *Perencanaan dan Pengembangan Perumahan*. Yogyakarta: Andi.
- [7] Makalalag, A., Gosal, P. H., & Hanny, P. (2019). Kajian Kota Kotamobagu Menuju Kota Layak Huni (Livable City). *Jurnal Spasial, Volume 6 No. 2*.
- [8] *perkim.id*. (2020, Desember 03). Retrieved from Strategi Penataan Kawasan Permukiman Kumuh dengan Konsep Collective Housing: <https://perkim.id/kumuh/strategi-penataan-kawasan-permukiman-kumuh-dengan-konsep-collective-housing/>
- [9] Sitawati, A., & Situmorang, R. (2016). *Materi Pokok Tata Guna dan Pengembangan Lahan; 1-9; PWKL4104*. Kota Tangerang Selatan, Provinsi Banten, Indonesia: Universitas Terbuka.
- [10] Wihadanto, A. (2018). *Analisis Potensi Penerapan Metode Penyesuaian Ulang Lahan (Land Readjustment) Dalam Pembangunan Perkotaan di Indonesia (Studi Kasus: Peremajaan Kota, Kampung Braga, Bandung)*. Institut Pertanian Bogor, Perencanaan Pembangunan Wilayah dan Perdesaan. Kota Bogor: Institut Pertanian Bogor.
- [11] Wijaya, D. W. (2016). Perencanaan Penanganan Kawasan Permukiman Kumuh (Studi Penentuan Kawasan Prioritas untuk Peningkatan Kualitas Infrastruktur pada Kawasan Permukiman Kumuh di Kota Malang). *Jurnal Ilmiah Administrasi Publik (JIAP)*.

SEAWEED CULTIVATION SARGASSUM SP. USING POCKET VERTICULTURE METHOD AT HIGH CURRENTS

BUDIDAYA RUMPUT LAUT SARGASSUM SP. MENGUNAKAN METODE VERTIKULTUR KANTONG PADA ARUS DERAS

Rinda Noviyanti

*Program Studi Agribisnis, Jurusan Pertanian, Fakultas Sains dan
Teknologi, Universitas Terbuka (INDONESIA)
rinda@ecampus.ut.ac.id*

Abstract

Seaweed has become a rapidly growing commodity. This can be seen from the increasing demand for domestic and foreign markets arising from the development of industries that utilize seaweed as their raw material. Indonesia is one of the largest seaweed producing countries in the world, but also has several obstacles, especially in the aquaculture sector, such as disease, epiphytic and predation attachments. This study is conducted to collect sufficient information on the cultivation of *Sargassum* sp. The method used in this study is through a literature review that collects several previous studies to study the effective method of cultivating *Sargassum* sp seaweed. The results of this literature study indicate that seaweed cultivation utilizing the pocket verticulture method at swift currents can increase production per unit of land, and reduce predation and epiphyte attachments. Another result is a decrease in the daily growth rate at each increase in depth, but on the other hand there can be an increase in content such as carrageenan, alginate and secondary metabolites due to pressure from light intensity obtained by *Sargassum* sp. Based on the results of this literature study, it can be concluded that the pocket verticulture method in heavy currents can maintain and improve the quality and quantity of production of *Sargassum* sp. per unit of land.

Keywords: Seaweed, *Sargassum*, verticulture, pocket, swift currents

Abstrak

Rumput laut telah menjadi komoditas yang sedang berkembang dengan cepat. Hal tersebut dapat dilihat dari meningkatnya kebutuhan pasar domestik dan luar negeri yang muncul akibat perkembangan industri-industri yang menggunakan rumput laut sebagai bahan bakunya. Indonesia termasuk dalam negara produsen rumput laut terbesar di dunia, namun juga memiliki beberapa kendala khususnya pada sektor budidaya, seperti terkena penyakit, penempelan epifit dan predasi. Studi ini dilakukan untuk mengumpulkan informasi yang cukup tentang budidaya rumput laut *Sargassum* sp. Metode yang digunakan dalam studi ini adalah melalui studi literatur yang mengumpulkan beberapa penelitian terdahulu untuk menjawab metode budidaya rumput laut *Sargassum* sp yang efektif. Hasil dari studi literatur ini menunjukkan bahwa budidaya rumput laut dengan metode vertikultur kantong pada arus deras dapat meningkatkan produksi tiap satuan lahan dan mengurangi predasi serta penempelan epifit. Hasil yang lain adalah penurunan laju pertumbuhan harian pada tiap kenaikan kedalaman, namun di sisi lain dapat terjadi peningkatan kandungan-kandungan seperti karaginan, alginat maupun metabolit sekunder karena adanya tekanan dari intensitas cahaya yang didapatkan oleh *Sargassum* sp. Berdasar hasil studi literatur ini maka dapat disimpulkan bahwa metode vertikultur kantong pada arus deras dapat tetap menjaga serta meningkatkan kualitas dan kuantitas produksi *Sargassum* sp. per satuan lahan.

Kata Kunci: Rumput laut, *Sargassum*, Vertikultur, Kantong, Arus Deras

1 PENDAHULUAN

Rumput laut termasuk dalam tumbuhan tingkat rendah karena tidak dapat dibedakan antara akar, batang, dan daunnya. Saat ini rumput laut telah menjadi komoditas yang sedang berkembang dengan cepat. Hal tersebut dapat dilihat dari meningkatnya kebutuhan pasar domestik dan luar negeri yang muncul akibat perkembangan industri-industri dengan menggunakan rumput laut sebagai bahan

bakunya. Penggunaan rumput laut sebagai bahan baku meluas pada industri makanan, kosmetik, farmasi, tekstil, hingga pertanian yang memanfaatkan hasil agar, karagenan, alginat sebagai stabilisator, pengemulsi, pengental, dan pembentuk gel (Nurjanah *et al.*, 2017; Safia *et al.*, 2020). Selain itu senyawa bioaktif dalam rumput laut seperti florotanin dan flavonoid memiliki kemampuan sebagai tabir surya karena menahan sinar ultraviolet (UV) (Dolorosa *et al.*, 2019; Nurjanah *et al.*, 2019), aktivitas antioksidan, antidiabetes dan antikanker alami (Balboa *et al.*, 2013; Yende *et al.*, 2014; Prasiddha *et al.*, 2016).

Indonesia termasuk dalam negara produsen rumput laut terbesar di dunia. Beberapa jenis rumput laut seperti *Kappaphycus alvarezii* dan *Glacilaria* sp. dari kelas Rhodophyceae sudah banyak dibudidayakan dan diperdagangkan (Muslimin dan Sari, 2016). Namun, jenis *Sargassum* sp. belum diusahakan secara optimal baik pada budidaya maupun industrinya. Kegiatan produksi *Sargassum* sp. kebanyakan masih secara alamiah (Basmal *et al.*, 2013; Muslimin dan Sari, 2017). *Sargassum* sp. memiliki kandungan alginat dan iodin yang banyak digunakan pada industri makanan, farmasi, kosmetik hingga tekstil (Pakidi dan Musamus, 2016). Selain itu, senyawa bioaktif seperti florotanin, fukosantin, asam fenolat dapat dijadikan sebagai pencegahan maupun terapi untuk berbagai penyakit (Balboa *et al.*, 2015; Payghami *et al.*, 2015; Sivagnanam *et al.*, 2015; Rohim *et al.*, 2019).

Pemanfaatan *Sargassum* sp. semakin meningkat karena banyaknya potensi yang terdapat pada rumput laut tersebut. Saat ini ada banyak variasi metode budidaya rumput laut. Metode yang umum digunakan yaitu metode lepas dasar, *long-line*, *floating net*, dan kombinasi antara *long-line* dan *floating net*. Selain itu, terdapat metode budidaya lain seperti metode cidaun (kantong) dan vertikultur. Untuk mendapatkan hasil produksi budidaya yang maksimal diperlukan beberapa faktor pendukung seperti penggunaan jenis rumput laut yang bermutu, metode budidaya yang intensif, penanganan pascapanen yang tepat serta kelancaran hasil produksi

(Patang dan Yunarti, 2013). Salah satu upaya yang dapat dilakukan pada metode budidaya adalah dengan melakukan suatu inovasi berupa penggabungan beberapa metode budidaya rumput laut yang sudah ada, yaitu metode vertikultur kantong pada arus deras. Metode ini merupakan modifikasi dari metode vertikultur. Dengan adanya inovasi tersebut, diharapkan pada penerapannya dapat memberikan sumbangan solusi terkait kendala pada kegiatan budidaya rumput laut *Sargassum* sp.

2 PEMBAHASAN

Metode vertikultur sudah diuji coba di Kabupaten Barru (Sulawesi Selatan) pada tahun 2009 oleh Balai Penelitian dan Pengembangan Budidaya Air Payau (BPPBAP). Lokasi pengembangan budidaya rumput laut metode vertikultur kebanyakan dilakukan selat sehingga memiliki kecepatan arus yang relatif tinggi. Budidaya metode vertikultur merupakan budidaya yang spesifik lokasi (Pong-Masak dan Sarira, 2015). Budidaya rumput laut dengan metode vertikultur dinilai mampu meningkatkan produksi hingga mencapai 420% dibandingkan dengan metode *long line* per satuan lahan (Pong-Masak dan Sarira, 2018).

Metode vertikultur dengan arus deras dikombinasi dengan metode kantong pada arus deras ini diharapkan dapat menghasilkan budidaya dengan hasil yang lebih baik. Budidaya rumput laut dengan menggunakan kantong (model cidaun) pada arus besar berfungsi agar bibit tidak rontok atau rusak saat terkena arus. Selain itu, model tersebut dapat menghasilkan berat basah rumput laut dengan rata-rata 10 kali dari berat awal bibit dalam waktu 30-45 hari (Susanto, 2005). Namun pada metode kantong yang telah dilakukan oleh Muslimin dan Sari, 2017 dengan membudidayakan *Sargassum* sp. memberi efek negatif bagi pertumbuhan rumput laut, hal ini disebabkan oleh kantong menjadi tempat penempelan suspensi berupa teritip dan hewan lainnya. Penempelan tersebut terjadi dikarenakan arus pada lokasi budidaya sangat tenang sehingga teritip atau hewan lainnya memiliki kesempatan untuk menempel pada

kantong budidaya. Penempelan ini justru menghalangi masuknya nutrien dan cahaya yang sangat dibutuhkan oleh rumput laut (Muslimin dan Sari, 2017). Dengan adanya arus kencang yakni berkisar 40-100 cm/det diharapkan dapat mengurangi potensi penempelan teritip dan biota lainnya sehingga mendapatkan hasil pertumbuhan yang lebih baik.

Desain Budidaya

Metode vertikultur sebaiknya diterapkan pada perairan dengan arus deras pada kecepatan lebih dari 40 cm/det, dengan kecerahan lebih dari 5 m, dan pada kondisi perairan dengan zat hara yang cukup. Metode ini cocok diterapkan pada kawasan pesisir yang berada di gugusan kepulauan sehingga memiliki pergerakan arus yang *continue*. Peralatan yang dibutuhkan dalam perancangan desain dengan pembuatan rakit apung berukuran 10 x 10 m² yaitu menggunakan balok kayu, jangkar beton, styrofoam, tali dan pipa pralon. Balok kayu berukuran 2 x 1,5m² dirakit dan didirikan sebanyak 36 buah sebagai tiang penggantung vertikultur berbentuk jaring dimana rumput laut dapat digantungkan pada tempat budidaya (Pong-Masak dan Sarira, 2015)

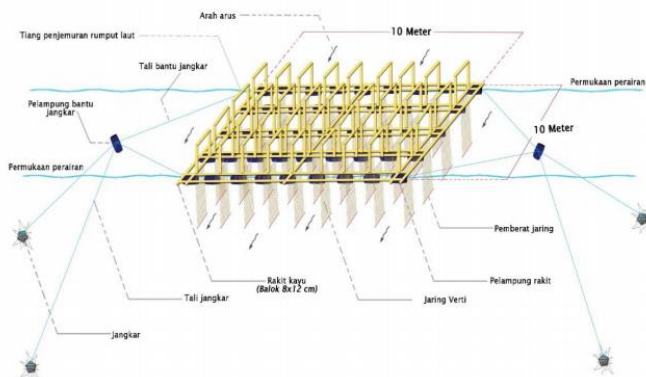

Gambar 1. Desain Konstruksi Metode Vertikultur

Sumber: Pong-Masak dan Sarira, 2015

Pelampung drum plastik/styrofoam dipasang pada rakit dengan searah arus laut. Beton ukuran 150 x 100 x 100 cm³ digunakan sebagai jangkar agar rakit tidak bergeser terbawa oleh arus. Desain tersebut menjadi acuan untuk dilakukannya modifikasi dengan menggunakan kantong pada setiap rumpun bibit. Desain kantong bibit rumput laut mengacu pada penelitian yang dilakukan oleh Muslimin dan Sari (2017) dengan diameter kantong 25cm, tinggi kantong 50cm dan ukuran jaring sebesar 3cm. Media pengikatan kantong bibit rumput laut menggunakan tali polietilen ukuran 8mm sebanyak 6 tali vertikal sepanjang 5m. Desain kantong dan media pengikatan kantong bibit yang merupakan modifikasi dari metode vertikultur tersaji secara berurutan pada Gambar 2 dan Gambar 3.



Gambar 2. Desain Kantong Bibit Rumput Laut

Sumber: Muslimin dan Sari, 2017

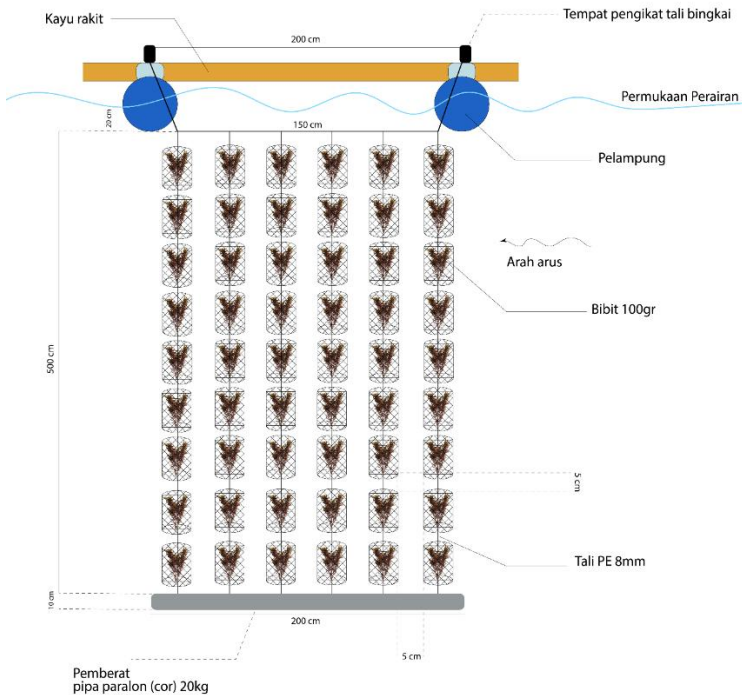

**Gambar 3. Desain Konstruksi Budidaya Vertikultur
 Kantong Tampak Samping**
 Sumber: Modifikasi dari Pong-Masak dan Sarira, 2015

Rancangan media pengikatan kantong bibit mengacu pada metode vertikultur yang dilakukan oleh Pong-Masak dan Sarira (2015) dengan modifikasi penggunaan kantong pada setiap rumpun bibit. Jarak antar rumpun (kantong) 5cm dengan bibit yang akan digunakan seberat 100gr. Penggunaan bibit dengan berat 100gr diduga dapat menghasilkan laju pertumbuhan yang tinggi karena bibit telah memiliki banyak cabang dan ruang tumbuh yang luas, sehingga penyerapan cahaya matahari dan zat hara akan lebih efektif. Hal tersebut dibuktikan oleh Sari dan Muslimin (2016) bahwa bibit rumput laut 100gr memiliki laju pertumbuhan harian (LPH) paling tinggi

dibandingkan bibit dengan berat 25gr, 50gr dan 75gr. Penggunaan berat bibit yang berbeda dapat menghasilkan hasil berat yang berbeda (Kotta, 2020). Tingginya pertumbuhan mutlak pada bibit yang lebih berat karena sudah banyak percabangan (*thallus*) sehingga lebih efektif menyerap zat hara (Afifilah *et al.*, 2021). Susanto (2005) menyatakan bahwa, penggunaan kantong bibit rumput laut berfungsi sebagai pelindung bibit agar tidak rontok atau hancur pada arus kencang. Selain itu model tersebut dapat meningkatkan berat basah rumput laut hingga 10 kali dari berat awal dalam waktu budidaya 30-45 hari.

Jarak tanam antar rumpun (kantong) juga dapat mempengaruhi pertumbuhan rumput laut. Pengaruh tersebut berasal dari adanya kompetisi antar bibit dalam menyerap zat hara dan cahaya matahari. Jika jarak tanam terlalu pendek, maka akan menyulitkan setiap *thallus* untuk memperoleh nutrient serta cahaya matahari. Persaingan antar *thallus* dalam penyerapan zat hara dan cahaya matahari sangat mempengaruhi pertumbuhan rumput laut (Abdan dan Ruslaini, 2013). Biasanya jarak tanam berkisar antara 20 – 25cm (Widiastuti, 2011). Jarak tersebut dinilai paling optimal karena rumput laut memiliki ruang yang cukup dalam melakukan fotosintesis dan menyerap zat hara. Jarak antar kantong yang digunakan pada desain vertikultur yaitu 5cm. Jarak ini diduga sudah cukup karena rumput laut telah memiliki ruang tumbuhnya masing-masing didalam kantong sehingga tidak akan terjadi kompetisi antar rumpun. Jarak tanam memiliki hubungan dengan persatuan lahan, karena akan mempengaruhi pergerakan air serta mengurangi terjadinya penumpukan kotoran pada *thallus*. Menurut Pong-Masak dan Sarira (2018) bahwa, jarak tanam yang panjang akan mempermudah terjadinya proses fotosintesis karena masing-masing *thallus* akan mendapatkan kesempatan yang sama dalam menerima cahaya matahari. Selain itu juga dapat mencegah terjadinya fluktuasi terhadap salinitas dan suhu perairan.

Kualitas Perairan

Metode vertikultur kantong pada arus deras meliputi beberapa faktor pada lingkungan perairan. Metode tersebut memiliki kriteria kelayakan lokasi yang sebaiknya dipenuhi. Kriteria ini memiliki prinsip yang hampir mirip dengan metode longline, hanya terdapat perbedaan pada kecepatan arus, kedalaman dan kecerahan perairan. Syarat kelayakan lokasi budidaya *Sargassum* sp. metode vertikultur disajikan pada Tabel 1

Tabel 1. Syarat Kelayakan Lokasi Budidaya *Sargassum* sp.
 Metode Vertikultur

Parameter	Kriteria
Parameter Fisika	
Keterlindungan	Terlindung dari Ombak ^a
Kecepatan Arus	40 - 100 cm/det ^a
Suhu	26 - 32°C ^{a,b}
Substrat	Pasir Berkarang ^b
Kedalaman	Lebih dari 10m ^a
Kecerahan	Lebih dari 5m ^a
Parameter Kimia	
Salinitas	32 - 35 ppt ^{a,b}
pH	7,1 – 8,2 ^{a,c}
Nitrat	0,9 – 1,51 mg/L ^{a,b}
Fosfat	0,02 – 0,05 mg/L ^{a,b}
Pencemaran	Nihil ^a
Parameter Biologi	
Makro Alga	Terdapat komunitas makro alga alami ^a
Predator/Pemangsa	Bebas dari biota air herbivor dalam jumlah yang banyak: penyusut, bulu babi dan ikan (herbivor) ^a
Aspek Non Teknis	
Keterjangkauan	Akses transportasi mudah ^a

Parameter	Kriteria
Legalitas lahan	Lahan budidaya tidak menimbulkan konflik ^a
Tenaga Kerja	Tersedia tenaga kerja yang memiliki komitmen dalam kegiatan budidaya ^a

Sumber: ^aPong-Masak dan Sarira, 2015; ^bMuslimin dan Sari, 2016, ^cFajri et al., 2020

Suhu

Suhu mempunyai peranan penting bagi pertumbuhan rumput laut. Kenaikkan suhu air yang tinggi dapat menyebabkan rumput laut menjadi stres sehingga mengganggu fungsi fisiologis dan menurunkan laju pertumbuhannya. Suhu air laut dapat mempengaruhi beberapa proses pada rumput laut seperti fotosintesis, pertumbuhan, respirasi dan reproduksi (Pong-Masak dan Sarira, 2018). Suhu air yang optimal untuk tanaman berkisar 26-30°C (Anggadiredja *et al.*, 2011), *Sargassum* sp. dapat hidup optimal pada suhu 28-32°C (Muslimin dan Sari, 2016).

Salinitas

Salinitas memiliki hubungan yang erat dengan tubuh organisme akuatik. Hubungan tersebut berperan langsung pada proses osmoregulasi yang berlangsung di dalam sel, sehingga semakin tinggi salinitas maka tekanan osmotik semakin besar pula. Kadi dan Atmadja (2006) mengatakan bahwa kisaran salinitas yang optimal untuk rumput laut di daerah tropis yaitu 32-34 ppt, sedangkan untuk *Sargassum* sp. salinitas yang optimum berkisar antara 32-35 ppt (Muslimin dan Sari, 2016)

pH

Nilai pH air laut dipengaruhi oleh kandungan garam karbonat dan bikarbonat di dalamnya. pH juga termasuk dalam faktor pembatas terhadap kehidupan suatu tumbuhan. Boedi *et al* (2014) menyebutkan bahwa pH air laut yang sesuai untuk hidup rumput laut berkisar antara

6-9. Dalam penelitian yang dilakukan oleh Fajri *et al.*, 2020 bahwa nilai pH yang masih optimal dalam pertumbuhan *Sargassum* sp. berkisar antara 7,1-8,2. Nilai tersebut masih tergolong sesuai untuk keberlangsungan kehidupan rumput laut.

Nutrient (Nitrat dan Fosfat)

Nutrient merupakan salah satu faktor penting untuk pertumbuhan rumput laut. Konsentrasi zat hara di perairan banyak dipengaruhi oleh kegiatan dari daratan, seperti adanya buangan limbah daratan yang terbawa oleh sungai menuju laut. Selain itu peristiwa *upwelling* juga dapat mempengaruhi kandungan zat hara (*nutrient*). Kandungan zat hara yang berlebih dapat menimbulkan eutrofikasi (pengkayaan) atau *blooming* karena dapat menstimulasi pertumbuhan alga dan tumbuhan. Nitrat dapat merangsang pembentukan *thallus* rumput laut dan proses reproduksi, sedangkan fosfat dalam bentuk adenosin trifosfat (ATP) merupakan faktor pendukung dan berperan dalam proses fotosintesis (Sulistijo dan Sjeifoul, 2006; Pong-Masak dan Sarira, 2018). Konsentrasi nitrat (mg/L) yang optimal untuk pertumbuhan rumput laut *Sargassum* sp. yaitu berkisar antara 0,16-1,51 mg/L, sedangkan untuk fosfat berkisar antara 0,02-0,05 mg/L (Muslimin dan Sari, 2016).

Kecepatan arus

Berdasarkan penelitian yang telah dilakukan oleh Pong-Masak dan Sarira (2018) bahwa, kecepatan arus yang cocok untuk metode vertikultur berkisar antara 40-100 cm/det. Nilai arus tersebut tergolong cukup deras sehingga dapat menyebabkan bibit rumput laut rontok atau rusak. Penggunaan kantong bibit dapat menjadi salah satu solusi untuk mencegah rontoknya bibit serta melindungi bibit dari predasi. Selain itu bibit dapat memiliki ruang tumbuhnya masing-masing sehingga tidak terjadi kompetisi antar rumpun dalam hal penyerapan cahaya matahari maupun zat hara. Arus laut yang besar juga dapat membantu dalam membersihkan kantong maupun bibit yang bisa ditempli oleh epifit maupun kotoran lainnya. Jika arus besar maka,

epifit tidak memiliki waktu yang cukup untuk menempel pada substrat, begitupun sebaliknya. Oleh sebab itu lokasi budidaya rumput laut dengan metode vertikultur kantong lebih cocok dilakukan di daerah selat yang memiliki arus deras.

Kecerahan dan Kedalaman

Kecerahan dan kedalaman perairan merupakan faktor penting dalam kegiatan budidaya menggunakan metode vertikultur. Kedua faktor tersebut berhubungan erat dengan intensitas cahaya yang dapat masuk ke dalam perairan. Cahaya memiliki peran penting dalam pertumbuhan rumput laut, karena berhubungan langsung pada proses fotosintesis. Proses tersebut akan menghasilkan energi untuk dimanfaatkan oleh rumput laut pada reaksi gelap. Eismaputeri *et al* (2013) menyatakan penyinaran pada *Sargassum* sp. berpengaruh terhadap pertumbuhan. Kebutuhan cahaya untuk pertumbuhan *Sargassum* sp. lebih banyak dibandingkan dengan jenis rumput laut merah (Lutfiawan dan Karnan, 2015). Semakin dalam kecerahan cahaya yang masuk pada kolom perairan, maka akan semakin dalam juga kolom air yang dapat digunakan sebagai media budidaya rumput laut.

Pong-Masak dan Sarira (2015) mendapatkan bahwa laju pertumbuhan harian (LPH) tertinggi rumput laut *Kappaphycus alvarezii* menggunakan metode vertikultur didapatkan pada kedalaman 0,2m dan terendah pada kedalaman 5m. Kandungan karaginan *K. alvarezii* tertinggi ditemukan pada rumput laut yang berada pada kedalaman 5m dan terendah pada kedalaman 1m. Hal tersebut terjadi karena pasokan cahaya matahari akan lebih banyak pada permukaan kolom air, sehingga proses fotosintesis rumput laut berjalan dengan baik. Semakin dalam cahaya matahari yang masuk akan bias oleh air dan berkurang karena terhalang oleh rumpun bibit yang berada lebih dekat dengan permukaan, sehingga bibit yang berada paling bawah tidak mendapatkan pasokan cahaya yang cukup untuk berfotosintesis. Bibit rumput laut yang berada paling bawah akan mengalami stres dari kurangnya cahaya. Sehingga memaksa rumput

laut untuk melakukan metabolisme sekunder untuk bertahan hidup. Senyawa yang terbentuk dari proses metabolisme sekunder tidak memiliki fungsi khusus dalam pertumbuhan dan perkembangan, namun senyawa tersebut dibutuhkan untuk eksistensi kelangsungan hidup rumput laut (Safia *et al.*, 2020; Saifudin, 2014).

Tahapan Budidaya Metode Vertikultur Pemilihan Lokasi

Pemilihan lokasi budidaya mengikuti kriteria pada Tabel 1. yang merupakan referensi syarat kriteria kegiatan budidaya rumput laut metode vertikultur oleh Pong-Masak dan Sarira (2015). Lokasi budidaya harus terlindung dari gelombang besar, sehingga harus berdekatan dengan barrier reef untuk meredakan ombak dan gelombang. Kecepatan arus harus kencang karena mengingat digunakan kantong bibit agar tidak terjadi penempelan teritip atau hewan lainnya yang akan mengganggu pertumbuhan bibit rumput laut. Kedalaman perairan minimal 10m untuk menghindari kekeringan pada saat terjadi pasang-surut air laut. Kecerahan perairan minimal 5m agar bibit yang berada dibawah tetap mendapatkan cahaya matahari yang cukup untuk melakukan fotosintesis.

Lokasi budidaya harus aman dan legal agar tidak terjadi sengketa antara masyarakat sekitar, serta harus dilakukan hubungan sosial yang baik kepada masyarakat untuk keberlangsungan kegiatan budidaya. Keamanan lokasi budidaya harus diperhatikan dengan serius untuk menghindari pencurian baik itu alat maupun bahan untuk kegiatan budidaya. Selanjutnya dibuat konstruksi budidaya rumput laut sesuai dengan kriteria yang telah ditentukan.

Pemilihan Bibit

Bibit yang akan dibudidaya harus berkualitas baik, agar rumput laut dapat tumbuh dengan baik dan sehat. Dalam memilih bibit ada beberapa yang perlu diperhatikan yaitu:

- a. Umur *thallus* bibit harus muda, bercabang banyak, dan rimbun
- b. *Thallus* secara morfologi bersih, segar, berwarna cerah, dan bebas dari penyakit

- c. Bentuk thalus harus proporsional baik itu besar *thallus* dan panjang thalus
- d. Berat bibit yang digunakan sekitar 100gr untuk setiap rumpun

Penanaman Bibit

Bibit rumput laut yang telah dipilih dengan baik akan dimasukkan kedalam masing-masing kantong budidaya yang telah disiapkan sebelumnya (Gambar 2). Bibit harus segera ditanam pada lokasi budidaya agar bibir tidak mengalami stress, kekeringan, dan layu. Jaring dibawa dengan perahu sampai pada lokasi budidaya dan akan langsung ditebarkan pada masing-masing rakit.

Pemeliharaan

Bibit rumput laut akan dibudidaya dan dipelihara selama 45 hari, dengan beberapa kegiatan yang harus dilakukan secara berkala yaitu:

- a. Pengontrolan pada masing-masing kantong bibit seperti gangguan hewan pemangsa, pembersihan kantong jika terjadi penempelan kotoran, teritip atau hewan lainnya.
- b. Monitoring pertumbuhan rumput laut dengan menghitung laju pertumbuhan sehingga waktu panen dapat diprediksi

Panen

Panen dilakukan pada cuaca cerah dan pagi hari agar masih ada waktu untuk melakukan penjemuran rumput laut sebelum disimpan. Hal tersebut dilakukan untuk menjaga kualitas rumput laut sebelum dijemur kembali keesokan harinya. Jaring budidaya diangkat pada masing-masing rakit lalu dibawa ke pesisir dengan perahu dan nantinya akan dilakukan penjemuran

Penanganan Pascapanen

- a. Pengeringan/Penjemuran; Rumput laut yang telah dilepas (diambil) dari kantong bibit akan dijemur dengan menggantungnya pada tiang rakit bambu agar tidak terkena kontaminasi dengan tanah atau pasir.
- b. Sortasi; Pada saat penjemuran akan terbentuk butiran garam pada permukaan *thallus* rumput laut. Butiran tersebut perlu dibersihkan dengan cara menggoyangkan rumput laut sehingga

garam garam yang menempel jatuh. Rumput laut yang berkualitas baik apabila total garam dan kotoran yang melekat tidak lebih dari 3-5%

- c. Penyimpanan; Rumput laut yang sudah bersih dan kering dimasukkan ke dalam karung. Dalam Gudang penyimpanan rumput laut dijaga kelembabannya dengan mengatur sirkulasi udara serta pada setiap karung diberikan alas kayu dan terhindar dari air tawar untuk menjaga kesegaran rumput laut.

3 KESIMPULAN

Budidaya rumput laut *Sargassum* sp. menggunakan metode vertikultur kantong pada arus deras dinilai dapat meningkatkan kuantitas produksi rumput laut per satuan lahan, serta mendapatkan rumput laut dengan kandungan bioaktif yang tinggi pada bibit yang diletakkan pada rangkaian terdalam.

DAFTAR PUSTAKA

- [1] Abdan, A.R., Ruslaini. 2013. Pengaruh Jarak Tanam Terhadap Pertumbuhan dan Kandungan Karagenan Rumput Laut (*Euचेuma spinosum*) Menggunakan Metode *Long Line*. J. Mina Laut Indonesia 3(12): 113-123.
- [2] Afifilah, I., Cokrowati, N., Diniarti, N. 2021. The Weight of Seedlings Differs on the Growth of *Sargassum* sp. Jurnal Biologi Tropis, 21(1): 288-297 DOI: <http://dx.doi.org/10.29303/jbt.v21i1.2540>
- [3] Anggadiredja, J.T., Achmad Z., Heri, P., Sri, I. 2011. Rumput laut. Penebar Swadaya. Jakarta. 147 hal.
- [4] Balboa, E.M., Conde, E., Moure, A., Falqué, E., Domínguez, H. 2013. In Vitro Antioxidant Properties of Crude Extracts and Compounds From Brown Algae. Food Chemistry. 138, 1764–1785. <https://doi.org/10.1016/j.foodchem.2012.11.026>
- [5] Basmal, J., B.S.B. Utomo, Tazwir, Murdinah M.S, T. Wikanta, E. Marraskuranto, R. Kusumawati. 2013. Membuat Alginat dan Rumput Laut *Sargassum*. Penebar Swadaya. Jakarta : 91 hal.

- [6] Boedi, S., Julianto, Badrudin. 2014. Gracilaria Seaweed Cultivation In Pond. Fishery WWF-Indonesia. Jakarta. 20 Hal.
- [7] Dolorosa M.T, Nurjanah, Purwaningsih, Anwar E., Hidayat T. 2019. Tyrosinase Inhibitory Activity of *Sargassum plagyophyllum* and *Eucheuma cottonii* Methanol Extracts. IOP Conf. Ser.: Earth Environ. Sci. 278 012020
- [8] Eismaputeri, M.K., Alamsjah, M.A., Rahardja, B.S. 2013. Pengaruh Lama Penyinaran dan Salinitas Terhadap Pertumbuhan dan Jumlah Klorofil A *Sargassum* sp. Jurnal Ilmiah Perikanan dan Kelautan, 5(1): 99-104 <http://dx.doi.org/10.20473/jipk.v5i1.11432>
- [9] Fajri, I. M., Samidjan, D., Rachmawati. 2020. Pengaruh Jarak Tanam Rumput Laut (*Sargassum* sp.) yang Berbeda Terhadap Pertumbuhan. Sains Akuakultur Tropis: Indonesian Journal of Tropical Aquaculture. 4 (2). PP. 156-160. <https://doi.org/10.14710/sat.v4i2.6920>.
- [10] Kadi, A., Atmadja, S. 2006. Beberapa catatan kehadiran marga *Sargassum* di Perairan Indonesia. LIPI. Lampung. 76 hal.
- [11] Kotta. R. (2020). Pertumbuhan Rumput Laut *Kappaphycus alvarezii* Menggunakan Metode Budidaya Long Line Pada Kedalaman Berbeda Terhadap Peningkatan Berat Bibit : Kajian Pustaka. Jurnal Ilmu Kelautan Kepulauan. 3 (1): 46-58. DOI: <http://dx.doi.org/10.33387/jikk.v3i1.1860>
- [12] Lutfiawan, M., Karnan, L. J. 2015. Analisis Pertumbuhan *Sargassum* sp. dengan Sistem Budidaya yang Berbeda di Teluk Ekas Lombok Timur Sebagai Bahan Pengayaan Mata Kuliah Ekologi Tumbuhan. Jurnal Biologi Tropis. 15(2) : 129-138. DOI: <http://dx.doi.org/10.29303/jbt.v15i2.157>
- [13] Muslimin, Sari, W.K.P. 2016. Teknologi Budidaya Rumput Laut *Sargassum* sp. dengan Metode Lepas Dasar. Loka Penelitian dan Pengembangan Budidaya Rumput Laut. ISBN: 978-602-72533-4-6

- [14] Muslimin, Sari, W.K.P. 2017. Budidaya Rumput Laut *Sargassum* sp. dengan Metode Kantong pada Beberapa Tingkat Kedalaman di Dua Wilayah Perairan Berbeda. *Jurnal Riset Akuakultur*, 12(3): 221-230
- [15] Nurjanah, Nurilmala M, Anwar E, Luthfiyana N, Hidayat T. 2017. Identification of Bioactive Compounds of Seaweed *Sargassum* sp. and *Eucheuma cottonii* doty as a Raw Sunscreen Cream. *Proceedings of the Pakistan Academy of Sciences: B. Life and Environmental Sciences*. 54(4): 311- 318.
- [16] Nurjanah, Nurilmala M., Anwar E., Luthfiyana N., Hidayat T. 2019. Utilization of Seaweed Porridge *Sargassum* sp. and *Eucheuma cottonii* as Cosmetic in Protecting Skin. *IOP Conf. Ser.: Earth Environ. Sci.* 278 012055.
- [17] Pakidi, C. S. & Musamus, U. (2016). Potensi dan Pemanfaatan Bahan Aktif Alga Cokelat *Sargassum* sp. *Jurnal Octopus*. 5 (2), Juni 2016. DOI:<https://doi.org/10.26618/octopus.v5i2.720>
- [18] Patang, Yunarti. 2013. Pengaruh Berbagai Metode Budidaya dalam Meningkatkan Produksi Rumput Laut *Kappaphycus Alvarezii* (Kasus di Kecamatan Mandalle Kabupaten Pangkep). *Jurnal Galung Tropika*, 2(2), 60–63.
- [19] Payghami, N., Jamili, S., Rustaiyan, A., Saedinia, S., Nikan, M., Gohari, A.R. 2015. Alpha-amylase Inhibitory Activity and Sterol Composition of the Marine Algae, *Sargassum glaucescens*. *Pharmacognosy Research*. 7, 314–321. <https://doi.org/10.4103/0974-8490.167893>
- [20] Pong-Masak, P.R., Sarira, N.H. 2015. Petunjuk Teknis Teknologi Budidaya Rumput Laut *Eucheuma cottoni* dengan Metode Vertikultur. *Loka Riset Budidaya Rumput Laut*. ISBN: 978-602-72533-3-9
- [21] Pong-Masak, P.R., Sarira, N.H. 2018. Penentuan Jarak Tanam Optimal Antar Rumpun Bibit pada Metode Vertikultur Rumput Laut. *Jurnal Perikanan Universitas Gadjah Mada*, 20(1): 23-30. <https://doi.org/10.22146/jfs.33310>

- [22] Prasiddha, I.J., Laeliocattleya, R.A., Estiasih, T., Maigan, J.M. 2016. Potensi senyawa bioaktif rambut jagung (*Zea mays* L) untuk tabir alami. *Jurnal Pangan dan Agroindustri*. 4(1) :40-45
- [23] Rohim, A., Yuniarta, Estiasih, T. 2019. Senyawa-Senyawa Bioaktif Pada Rumpun Laut Cokelat *Sargassum* sp.: Ulasan Ilmiah. *Jurnal Teknologi Pertanian* Vol. 20 No. 2: 115-126
- [24] Safia, W., Budiyaniti, Musrif. 2020. Kandungan Nutrisi dan Senyawa Bioaktif Rumpun Laut (*Euchema cottonii*) yang Dibudidayakan dengan Teknik Rakit Gantung Pada Kedalaman Berbeda. *Jurnal Pengolahan Hasil Perikanan Indonesia*, 23(2), 261–271.
- [25] Saifudin, A. 2014. Senyawa Alam Metabolit Sekunder Teori, Konsep, dan Teknik Pemurnian. Yogyakarta (ID): Deepublish.
- [26] Sari, W.K.P., Muslimin. 2016. Penentuan Bobot Bibit, Jarak Rumpun, dan Jarak Tali Bentangan Untuk Optimalisasi Budidaya Rumpun Laut *Sargassum duplicatum* dengan Metode Lepas Dasar di Perairan Manunggu Kabupaten Boalemo, Gorontalo. *Prosiding Forum Inovasi Teknologi Akuakultur*: 509- 517
- [27] Sivagnanam, S.P., Yin, S., Choi, J.H., Park, Y.B., Woo, H.C., Chun, B.S. 2015. Biological Properties of Fucoxanthin in Oil Recovered From Two Brown Seaweeds Using Supercritical CO₂ Extraction. *Marine Drugs*. 13, 3422–3442. <https://doi.org/10.3390/md13063422>
- [28] Sulistijo, Sjeifoul. 2006. Pengaruh Pergantian Air Laut Terhadap Perkembangan Zigot *Sargassum polycystum*. *Oseanologi dan Limnologi di Indonesia* 17 (41): 15-38.
- [29] Susanto, A.B. 2005. Metode Lepas Dasar dengan Model Cidaun pada Budidaya *Euchema spinosum* (Linnaeus) Agardh. *Indonesian Journal of Marine Sciences*, 10(3): 158-164. doi:10.14710/ik.ijms.10.3.158-164

- [30] Widiastuti, I.M. 2011. Produksi *Gracilaria verrucosa* yang Dibudidayakan di Tambak Dengan Berat Bibit dan Jarak Tanam yang Berbeda. *J. Agrisains* 12 (1): 57-62.
- [31] Yende, S.R., Harle, U.N., Chaugule, B.B. 2014. Therapeutic Potential and Health Benefits of Sargassum Species. *Pharmacognosy Review*. 8, 1–7. <https://doi.org/10.4103/0973-7847.125514>

IMPLEMENTATION OF THE PHILOSOPHY OF VALUE AND LOCAL WISDOM OF THE SAKAI INDIGENOUS COMMUNITY IN SUSTAINABLE DEVELOPMENT GOALS

IMPLEMENTASI FILSAFAT NILAI DAN KEBIJAKSANAAN LOKAL MASYARAKAT ADAT SAKAI DALAM TUJUAN PEMBANGUNAN BERKELANJUTAN

**Lina Asnamawati¹, Mery Berlian², Is Eka Herawati³,
Timbul Rasoki⁴, Ana Nurmalia⁵**

*¹Program Studi Agribisnis, Fakultas Sains dan Teknologi,
Universitas Terbuka (INDONESIA)*

*²Program Studi Agribisnis, Fakultas Pertanian,
Universitas Dehasen (INDONESIA)*

linaas@ecampus.ut.ac.id

Abstract

The implementation of philosophical values, local wisdom, recognition and respect for indigenous peoples is a matter of discrimination in carrying out government policies. The implementation of the recognition of philosophical values and local wisdom is still not recognized. This study aims to analyze the philosophy of values and local wisdom of indigenous people and find things that cause of the low protection of the Sakai Indigenous people. This research can provide an insight into the local wisdom of the Sakai Indigenous community which aims for sustainable development. The Sakai indigenous people are people who live in Pekanbaru Province. This research was conducted using a qualitative approach with a case study method. The local wisdom possessed by the Sakai indigenous community is in the form of ideas, values or views from a place that has wise and good values which are followed and trusted by the people in that place and have been followed for generations. The

values of local wisdom of people who depend on nature for generations in implementing agriculture and cultivation. The Sakai indigenous people have a belief that there is Batu Betuah, community activities are always marked by certain ceremonies or beliefs. The local wisdom of the Sakai indigenous people in the form of customary values and norms is contained in the activities and use of technology. Keywords: Philosophical Values, Local Wisdom, Indigenous People, Sustainable Development Goal

Abstrak

Penerapan nilai-nilai filosofis, kearifan lokal, pengakuan dan penghormatan terhadap masyarakat adat merupakan hal yang diskriminatif dalam menjalankan kebijakan pemerintah. Pelaksanaan pengakuan nilai-nilai filosofis dan kearifan lokal masih belum diakui. Penelitian ini bertujuan untuk menganalisis filosofi nilai dan kearifan lokal masyarakat adat dan menemukan hal-hal yang menjadi penyebab rendahnya perlindungan terhadap masyarakat adat Sakai. Penelitian ini dapat memberikan wawasan tentang kearifan lokal masyarakat Adat Sakai yang bertujuan untuk pembangunan berkelanjutan. Masyarakat Adat Sakai adalah masyarakat yang berdomisili di Provinsi Pekanbaru. Penelitian ini dilakukan dengan menggunakan pendekatan kualitatif dengan metode studi kasus. Kearifan lokal yang dimiliki oleh masyarakat adat Sakai berupa gagasan, nilai atau pandangan dari suatu tempat yang memiliki nilai-nilai arif dan baik yang dianut dan dipercayai oleh masyarakat di tempat tersebut dan telah dianut secara turun temurun. Nilai-nilai kearifan lokal masyarakat yang bergantung pada alam secara turun temurun dalam melaksanakan pertanian dan budidaya. Masyarakat adat Sakai memiliki kepercayaan adanya Batu Betuah, kegiatan masyarakat selalu ditandai dengan upacara atau kepercayaan tertentu. Kearifan lokal masyarakat adat Sakai berupa nilai dan norma adat tertuang dalam aktivitas dan pemanfaatan teknologi. Kata Kunci: Nilai Filosofis, Kearifan Lokal, Masyarakat Adat, Sustainable Development Goal

1 PENDAHULUAN

Kearifan lokal merupakan pengetahuan, gagasan, strategi dan pandangan yang diaplikasikan dalam kehidupan untuk pemenuhan kebutuhan hidup. Kearifan Lokal juga diartikan sebagai nilai nilai bijak yang telah diterapkan secara turun menurun (Wardiyanta, et al, 2020). Kearifan bentuk dan diaplikasikan suatu kelompok masyarakat atau suku untuk kebijakan dan kebajikan kelompoknya.

Suku Sakai yakni suku di pedalaman Kepulauan Riau Sumatera, sejarah suku sakai berasal dari pagaruyung merupakan kerajaan melayu. Sakai merupakan salah satu suku yang mendiami kawasan pedalaman Riau di Pulau Sumatera. Masyarakat adat Sakai sudah berada di peta sejak 1840. Sebelum Jepang datang menjajah Indonesia, suku sakai sudah ada Asal mula suku sakai yaitu berasal dari kerajaan siak yang dibantu oleh kerajaan pagaruyung dan sriwijaya. Suku Sakai berarti orang yang kuat. Sistem pemerintahan pada masyarakat adat Sakai meyerupai sistem pemerintahan di Pagaruyung. Di malaysia juga terdapat Suku Sakai. Suku sakai yaitu mayarakat yang melakukan pelarian dari pagaruyung. Suku pribumi adalah berasal dari kerajaan pagaruyung dalam hal perdagangan datang ke pekanbaru. Karena ada akses malaka ke dumai. 5 Suku : tanah patah, lima puluh satu, kampai, pedagang. Suku sakai artinya keras. Ada local bisnis, reformasi sudah modern 13 budaya suku sakai: suku batang puluh, sebayu, majalelo, leopati pati, sakar batu, delapan batu, sebayur, betuah, kubungm singo melayu, romban pati (Isdarwanto dan Zulfa, 2010)

Suku Sakai merupakan komunitas asli suku pedalaman yang hidup di daratan Riau. Suku Sakai dicirikan sebagai kelompok terasing yang hidup berpindah-pindah. Masyarakat Adat Sakai dalam merupakan warga sakai yang masih hidup setengah menetap dalam rimba belantara, dengan mata pencarian berburu, menangkap ikan dan mengambil hasil hutan. Sakai luar adalah warga yang mendiami perkampungan berdampingan dengan pemukiman-pemukiman puak melayu dan suku lainnya. Sakai berasal dari buku bab alquaid, anak negri yang berasal dari kerajaan siak.

Masyarakat Adat Suku Sakai tinggal di Kota Duri di Kabupaten Bengkalis, mereka hidup di hamparang lading minyak yaitu di Desa Kesumbo Ampai, Kecamatan Mandau. Mereka hidup di sepanjang ladang minyak perusahaan. Jarak dari kota Pekanbaru sekitar 200 km. Sekitar 300 KK yang hidup diantara perkebunan sawit dan lading minyak. Mata pencaharian masyarakat adat Sakai bergantung pada sawit, karet dan hasil hutan dan sungai. Rumah masyarakat terbuat dari papan, dan mereka bergantung hidup terhadap sungai yang sudah tercemar minyak perusahaan. Masyarakat hidup sangat sederhana dan tidak terlihat kemewahan yang mereka rasakan. Padahal mereka hidup diantara perusahaan minyak

Suku Sakai memeluk ajaran animisme, namun sekarang ini sudah banyak masyarakat adat Suku Sakai merupakan agama islam. Kepercayaan animisme, namun sekarang ini sudah banyak islam karena datuk mengislamkan orang sakai. Mejlis tinggi adat, Lembaga adat melayu riau, kawasan mandau, wilayah kecamatan mandau, pematang kudu. Namun Suku sakai mempercayai terhadap kekuatan magis dan makhluk halus yang mereka kenal dengan Antu. Masyarakat Adat Suku Sakai mempercayai bahwa Antu memiliki kehidupan seperti manusia. Masyarakat Adat Sakai memiliki kepercayaan bahwa Antu berada di tengah rimba hutan belantara yang sulit didatangi oleh manusia.

Suku Sakai merupakan kedalam ras veddoid yang memiliki ciri-ciri rambut keriting berombak dengan tinggi sekitar 145 sd 155 cm. Suku sakai menggunakan Bahasa Sakai. Tinggal didalam hutan dan bertahan hidup dengan berburu, mengail dan mengambil hasil hutan. Hutan berfungsi mengembangkan nilai-nilai budaya. Masyarakat adat memanfaatkan keberadaan hutan dalam aspek ekonomi, sosial, lingkungan, politik, budaya, agama, seni, dan sebagainya. Hutan tanah adat bagi mereka bukan semata-mata merupakan kekayaan material untuk memenuhi hajat hidup, tetapi bahkan mengandung nilai. Permasalahan lingkungan disebabkan karena banyak pelanggaran yang dilakukan dan melanggar mengindahkan kaidah-

kaidah ajaran Melayu yang mengajarkan agar hidup berdampingan dengan alam serta memelihara alam untuk generasi selanjutnya.

Masyarakat adat yang tidak patuh menjalankan aturan adat dipengaruhi oleh pengaruh masyarakat luar. Hutan dan lingkungan tidak bisa dipisahkan dari kehidupan masyarakat adat. Pemanfaatan sumber daya alam yang melebihi ambang batas daya dukung lahan dan tanpa memperhatikan aspek kelestariannya akan mendorong terjadi erosi dan longsor, seperti yang banyak terjadi sekarang ini. Akibat kondisi tersebut menyebabkan degradasi lahan, pendangkalan sungai. Hutan adat banyak dieksploitasi oleh pengusaha besar yang menanam kelapa sawit dalam jumlah yang besar. Dampak dari penanaman sawit dalam jumlah besar menyebabkan krisis air, pendangkalan sungai, kepunahan. Dampak ekologis penanaman sawit secara besar-besaran menyebabkan berbagai persoalan ekologis, seperti krisis air, pendangkalan sungai, kepunahan flora dan fauna.

Pemanfaatan hutan tanah dalam pelestarian lingkungan bagi masyarakat adat mengandung nilai-nilai pemeliharaan alam flora dan fauna. Kearifan lokal terhadap lingkungan untuk memelihara alam menggunakan akal pikiran. Masyarakat adat menjaga lingkungan karena menurut mereka masyarakat adat yang merusak alam merupakan orang yang tidak memiliki akal dan berperilaku tidak baik. Oleh karena itu hal yang menarik memahami kearifan local masyarakat adat dalam pelestarian hutan dan lingkungan.

Hutan sangat penting bagi kehidupan masyarakat adat karena kehidupan masyarakat tidak dapat dipisahkan dari hutan. Hutan sangat penting bagi kehidupan masyarakat adat karena kehidupan masyarakat tidak dapat dipisahkan dari hutan. Hutan memberikan sumber kehidupan ekonomi, ekologis, politik, social budaya. Kearifan lokal yang dimiliki masyarakat adat sangat penting dipelajari agar terciptanya pelestarian hutan dan lingkungan. Hutan dan lingkungan dimanfaatkan oleh masyarakat adat dalam nilai sosial, norma adat, etika lingkungan, sistem kepercayaan, pola penataan ruang tradisional, peralatan dan teknologi sederhana ramah lingkungan.

Hubungan tanah dan masyarakat adat ditandai dengan produktivitas, *sustainability*, *equitabilitas*, bijaksana, benar, tepat, serasi, dan harmonis. Sehingga penting dilakukan analisa terkait perilaku dan kearifan lokal masyarakat adat Sakai di Provinsi Pekanbaru dan analisa implementasi nilai filosofi dan kearifan lokal masyarakat adat Sakai dalam *sustainable development goals*.

2 METODOLOGI

Metode pengumpulan data ialah teknik yang dipilih peneliti untuk mengumpulkan data (Riduwan, 2010). Pengumpulan data adalah suatu proses menghimpun informasi untuk keperluan penelitian (Nazir, 2009). Pengumpulan data dalam penelitian ini dengan menggunakan observasi dan wawancara.

Penelitian dilakukan dengan metode survei, yaitu pengambilan data pada sampel / responden (Suryabrata 2006). Metode survei umumnya digunakan pada penelitian sosial, dengan tujuan untuk menerangkan suatu fenomena sosial atau suatu peristiwa (*event*) sosial. Penelitian dilaksanakan dengan pendekatan kualitatif dan studi kasus. Informasi yang diperoleh berdasarkan wawancara mendalam dengan informan yang merupakan tokoh adat 2 dan ketua adat sebanyak 1, perangkat desa 1 orang serta 7 orang masyarakat Adat Sakai

Penelitian ini dilaksanakan pada masyarakat adat Sakai di Provinsi Pekanbaru, Penelitian ini menggunakan metode penelitian kualitatif yang bersifat deskriptif. Menurut koentjaraningrat (1991) penelitian kualitatif yakni penelitian deskriptif yang menggambarkan suatu keadaan secara gamblang. Metode deskriptif merupakan pemaparan hasil dari wawancara dengan responden (Moleong, 2006). Indikator yang digunakan yang digunakan adalah sistem pengetahuan mengenai sikap dan perilaku dalam mengelola lingkungan hidup dan kegiatan dalam melindungi dan mengelola lingkungan. Informan dalam penelitian kualitatif ini yaitu Para Ketua Adat Suku Sakai, Pemerintah Daerah dan Masyarakat Adat Suku Sakai yang memiliki pengaruh di Masyarakat.

3 HASIL

3.1 Kondisi Geografis Masyarakat Adat Sakai

Salah satu suku yang hidup di daerah pedalaman Riau, di pulau Sumatera adalah suku Sakai. Suku sakai ini memiliki nenek moyang yang berasal dari pagaruyung yang merupakan salah satu kerajaan melayu yang berada di pulau Sumatera. Sakai berasal dari singkatan beberapa kata yaitu Sungai, Kampung, Anak dan Ikan. Untuk mempertahankan keberlangsungan hidupnya suku ini memanfaatkan hasil di sekitar sungai, maka dari itu suku tersebut memilih untuk hidup di daerah sekitaran sungai.

Masyarakat adat Sakai sudah berada di peta sejak 1840. Sebelum Jepang datang menjajah Indonesia, suku sakai sudah ada. Asal mula suku sakai yaitu berasal dari kerajaan siak yang dibantu oleh kerajaan pagaruyung dan sriwijaya. Suku Sakai berarti orang yang kuat. Sistem pemerintahan pada masyarakat adat Sakai menyerupai sistem pemerintahan di Pagaruyung. Di Malaysia juga terdapat Suku Sakai. Suku sakai yaitu masyarakat yang melakukan pelarian dari pagaruyung. Suku pribumi adalah berasal dari kerajaan pagaruyung dalam hal perdagangan datang ke Pekanbaru. Karena ada akses Malaka ke Dumai. 5 Suku : tanah patah, lima puluh satu, kampai, pedagang. Suku sakai artinya keras. Ada local bisnis, reformasi sudah modern 13 budaya suku sakai: suku batang puluh, sebayu, majalelo, leopati pati, sakar batu, delapan batu, sebayur, betuah, kubungm singo melayu, romban pati.

Suku Sakai ini merupakan sebuah kelompok atau komunitas asli pedalaman yang hidup di daratan pulau Sumatera lebih tepatnya di Riau, ciri dari suku ini ialah hidup nomaden atau berpindah-pindah. Masyarakat adat Sakai terbagi atas dua, yaitu masyarakat adat sakai dalam yang memiliki kehidupan setengah menetap di hutan dengan cara bertahan hidup atau bermata pencaharian berburu, mengambil hasil hutan, dan menangkap ikan. Sedangkan masyarakat adat Sakai luar lebih memilih untuk mendiami sebuah pemukiman atau perkampungan dan hidup bertetangga atau berdampingan dengan

suku lainnya. Kata “Sakai” berasal dari buku bab alquaid, anak negeri yang berasal dari kerajaan siak.

Masyarakat Adat Suku Sakai tinggal di Kota Duri di Kabupaten Bengkalis , mereka hidup di hamparan lading minyak yaitu di Desa Kesumbo Ampai, Kecamatan Mandau. Mereka hidup di sepanjang ladang minyak perusahaan. Jarak dari kota Pekanbaru sekitar 200 km. Sekitar 300 KK yang hidup diantara perkebunan sawit dan lading minyak. Mata pencaharian masyarakat adat Sakai bergantung pada sawit, karet dan hasil hutan dan sungai. Rumah masyarakat terbuat dari papan, dan mereka bergantung hidup terhadap sungai yang sudah tercemar minyak perusahaan. Masyarakat hidup sangat sederhana dan tidak terlihat kemewahan yang mereka rasakan. Padahal mereka hidup diantara perusahaan minyak

Suku Sakai memeluk ajaran animisme, namun sekarang ini sudah banyak masyarakat adat Suku Sakai merupakan agama islam. Kepercayaan animisme, namun sekarang ini sudah banyak islam karena datuk mengislamkan orang sakai. Mejlis tinggi adat, Lembaga adat melayu riau, kawasan mandau, wilayah kecamatan mandau, pematang kudu. Namun Suku sakai mempercayai terhadap kekuatan magis dan makhluk halus yang mereka kenal dengan Antu. Masyarakat Adat Suku Sakai mempercayai bahwa Antu memiliki kehidupan seperti manusia. Masyarakat Adat Sakai memiliki kepercayaan bahwa Antu memiliki kehidupan di dalam hutan belantara yang menurut mereka susah di datangi oleh manusia.

Suku Sakai merupakan kedalam ras veddoid yang memiliki ciri-ciri rambut keriting berombak dengan tinggi sekitar 145 sd 155 cm. Bahasa yang digunakan yaitu Bahasa Sakai. Suku sakai yang masih hidup hingga saat sekarang memenuhi kebutuhan hidup dengan cara berburu, mengumpulkan hasil hutan dan ikan.

3.2 Perilaku dan Kearifan Lokal Masyarakat Adat Sakai Perilaku Masyarakat Adat Sakai terhadap Pelestarian Hutan dan Lingkungan

Suku sakai merupakan suku yang sangat dengan alam. Suku sakai hidup didalam hutan. Hutan sebagai rumah dan tempat untuk memenuhi kebutuhan hidup dengan cara bertani. Sayangnya, kawasan hutan seiring waktu berubah menjadi daerah industri dan usaha. Pemerintah untuk mengkonversi hutan alam menjadi Hutan Tanaman Industri serta pembangunan kilang minyak oleh perusahaan Caltex atau Cevron (Saputra et al., 2021). Wilayah Suku Sakai pun mulai kehilangan kehidupannya. Pola hidup Suku Sakai yang selalu berusaha menjaga keseimbangan ekosistem alam membuat mereka dijuluki suku penjaga hutan.

Namun sekarang ini hutan semakin rusak karena sejumlah pantangan aturan adat yang sudah mulai pudar pada masyarakat. Alasan lain yang membuat Suku sakai mulai hilang adalah karena rendahnya pengetahuan mereka tentang kemajuan dan teknologi. Sehingga mereka sering diremehkan dan dimanfaatkan oleh orang-orang yang tak bertanggung jawab yang ingin merusak alam.

Warga sakai hidup setengah menetap didalam rimba dengan berburu. Sakai terbagi atas dua yakni Sakai Luar dan Sakai Dalam (Isdarwanto dan Zulfa, 2010). Sakai dalam merupakan warga yang masih tinggal didalam hutan dan memenuhi kebutuhan hidup di dalam rimba, sedangkan sakai luar yakni warga Sakai yang telah hidup berdampingan dengan pemukiman warga diluar rimba. Suku Sakai memiliki tradisi upacara adat yang berkaitan peristiwa alam diantaranya, upacara menanam padi, upacara menyang, upacara sorang sirih, upacara tolak bala. Saat ini masyarakat suku sakai telah mulai mengenal keyakinan, sebagian memeluk agama islam dan bersekolah. Suku sakai luar memiliki berbagai pencaharian yakni, peramu, guru, pedagang, petani, nelayan dan pegawai negeri sipil. Meskipun telah berevolusi menjadi lebih moderen suku luar sakai masih melaksanakan upacara daur hidup. Upacara adat tetap dilaksanakan sebagai bentuk kepercayaan dan penghormatan

kepada para leluhur. Suku sakai mempercayai jika tidak melaksanakan upacara adat maka akan datang musibah salah satunya adalah datangnya antu (makhluk gaib).

Kehidupan berladang Suku Sakai juga menganut aturan sendiri. Salah satunya aturan dalam pembukaan hutan untuk dijadikan ladang. Hukum adat mengatur kehidupan berladang masyarakat Suku Sakai. Jika hukum adat tersebut dilanggar, tanaman atau tumbuhan yang sudah ditanam nantinya akan rusak oleh hewan liar atau hama. Hutan alam dengan pepohonan raksasa yang tersisa kini baru dijaga setelah sebagian besarnya 'hilang' dijarah para penguasa dan pengusaha.

Masyarakat Adat Sakai menangkap ikan dengan menombak, mengail serta menggunakan tangguk. Kegiatan menangkap ikan di rawa-rawa atau di sungai-sungai kecil dengan menggunakan lukah dan jaring. Mereka memasang lukah dari jaring pada sore hari menjelang malam dan pada pagi hari dapat dilihat hasil tangkapannya. Adapun larangan menangkap ikan dengan putas, pukut, sentrum dan racun bisa didenda adat berupa uang adat yang disepakati Pengurus Bathin (Kepala, Manti, Mangku). Bentuk larangan lain yaitu menebang hutan dekat sungai dan danau (Efendy dan Putra, 2017)

Kebudayaan Suku Sakai yang bercorak agraris juga ditandai dengan alat-alat yang berfungsi sebagai alat pertanian seperti gegalung galo. Alat yang terbuat dari bambu dan batang pepohonan ini berfungsi sebagai alat penjepit ubi manggalo untuk diambil sari patinya. Sebelumnya, ubi manggalo yang telah dikupas dikumpulkan di dalam wadah yang disebut tangguk. Suku Sakai juga memproduksi pakaian yang bahannya seratus persen terbuat dari alam. Pakaian orang-orang suku ini dahulu ketika masih hidup dalam sistem nomaden terbuat dari kulit kayu. Pakaian inilah yang digunakan Suku Sakai untuk bertahan hidup selama berpindah-pindah tempat.

Suku Sakai merupakan salah satu keragaman budaya Indonesia. Meskipun cara hidup masih berpindah-pindah namun masyarakatnya sudah mengenal teknologi. Suku sakai menciptakan alat – alat untuk

bertahan hidup dan memenuhi kebutuhan. Salah satu alat yang Suku Sakai ciptakan yakni timo; wadah penampung madu yang dibuat menggunakan bahan kulit hewan dan rotan.

Masyarakat sakai juga memiliki norma tersendiri saat berladang. Salah satunya adalah aturan pembukaan lahan. Jika aturan tersebut dilanggar maka selain hasil produksi yang akan dirusak hewan liar juga mereka percaya para antu akan mengganggu masyarakat tersebut dalam proses berladang.

Kegiatan berburu masyarakat Adat Sakai yaitu tidak boleh membunuh hewan tangkapannya, namun mereka melakukan dengan menjerat menggunakan Konjouw. Konjouw merupakan tombak yang terbuat dari besi yang dipanaska yang sudah dimantra. Hewan yang sering dilakukan perburuan yaitu babi hutan, kera, kijang, kelinci. Hasil tangkapannya digunakan untuk makan. Tanaman yang dibudidayakan berupa cabe, palawija, jagung, kambing. Suku Sakai sangat bergantung kepada alam, meskipun sebagian dari mereka sudah menerapkan pertanian dan juga berladang. Alam merupakan rumah mereka dan juga tempat mencari penghidupan. Namun sekarang ini, kawasan hutan seiring waktu berubah menjadi daerah industri dan usaha, Suku Sakai pun mulai kehilangan kehidupannya.

3.2.1 Kearifan Lokal Masyarakat Adat Sakai

Dengan menggantungkan hidupnya dengan alam, masyarakat suku ini sebisa mungkin melakukan semua kegiatan untuk memenuhi kehidupannya dengan bahan yang terdapat di alam. Suku sakai juga melakukan kehidupan berladang dengan menggunakan sistem atau aturan yang mereka buat sendiri. Salah satu aturan yang masyarakat suku sakai ciptakan sendiri adalah dengan cara melakukan pembukaan lahan di hutan untuk dijadikan lahan pertanian. Terdapat juga hukum adat yang mengatur kehidupan suku ini. Menurut mereka jika melanggar hukum adat tersebut, maka tanaman yang telah ditanam oleh masyarakat akan mengalami kegagalan atau rusak oleh hewan liar dan hama.

Mayarakat adat Sakai memiliki keyakinan ada Batu betuah: setiap ucapan jadi kejadian Padi gogo: kapan bias menang, mulai dari menanam. Bakar kemenyan, bawa ayam, ngambil ikan, melihat arah angin. Masyarakat adat sakai yang hidup berbaur dengan orang nias. Masyarakat Adat Sakai sangat bergantung hidup dari alam, mereka membuat ssesuatu yang berasal semuanya dari alam. Seperti Timo merupakan wadah yang terbuat dari kulit kerbau yang dikeringkan.

Corak kebudayaan masyarakat Sakai merupakan bercocok tanam yang ditandai dengan peralatan yang dimiliki oleh suku ini memiliki fungsi untuk bertani. Salah satu alat yang digunakan untuk bertani oleh suku ini adalah “Gegalung galo”. Gegalung galo merupakan adalah sebuah alat yang berbahan dasar bambu dan batang pohon yang memiliki fungsi sebagai alat penjepit ubi manggalo sehingga dapat diambil saripatinya dengan alat tersebut. Untuk mengeluarkan saripati dari ubi ini sebelumnya ubnya telah dikupas dan dikumpulkan dalam wadah yang diberi nama “tangguk”. Peralatan lainnya yaitu “Timo” yang memiliki bahan dasar kulit kerbau dan berfungsi sebagai wadah yang dikeringkan. Timo ini biasa digunakan oleh masyarakat suku Sakai unuk menyimpan madu.

Nilai-nilai dan norma adat yang yang digunakan oleh masyarakat ini sangat melekat dengan aktivitas dan penggunaan teknologi. Kearifan lokal masyarakat adat Sakai berupa sikap dan perilaku masyarakat adat sakai sehari hari seperti penggunaan alat : penggunaan beliung yaitu merupakan alat yang digunakan untuk menebang, kapak merupakan alat untuk membelah, lading merupakan alat untuk melakukan penebasan, tajak adalah alat yang digunakan suku ini untuk menyayat dan menyang, cabak adalah alat yang digunakan untuk membalikkan tanah di ladang, dan sabit alat untuk membersihkan rumput, tembilang alat yang digunnakan untuk menggali tanah oleh masyarakat adat Sakai.

Suku sakai juga melakukan kegiatan produksi yang menggunakan bahan yang seluruhnya berasal dari alam. Adapun bebrapa barang yang diproduksi oleh suku ini antara lain: Pakaian yang terbuat oleh serat kayu, karena masyarakat ada sakai ini hidup

berpindah-pindah maka pakaian ini sangat berfungsi untuk digunakan saat bertahan hidup. Pola hidup yang nomaden atau berpindah-pindah, masyarakat adat sakai menciptakan beberapa alat untuk mereka bertahan hidup seperti alat rumah tangga yang digunakan untuk memanfaatkan hasil alam. Masyarakat Desa Kesumbo Ampai memiliki sebuah kepercayaan jika ingin mengambil madu tidak boleh atau serta merta langsung mengambil saja, akan tetapi harus meminta izin terlebih dahulu kepada batin petani yang memiliki pohon ara. Dan masyarakat adat Sakai saat bertani di ladang memiliki cara untuk menanam di lubang dengan cara “menunggal”.

Ada beberapa peralatan sederhana yang diciptakan oleh suku sakai untuk memudahkan mereka, salah satunya: “beliung” adalah alat yang diciptakan sangat sederhana dengan bahan dasar batu dan dilengkapi oleh tangkai. Lalu pakaian juga dibuat sederhana dengan bahan yang sudah ada di alam dengan mengambil serat kulit kayu saat mereka berpindah-pindah. Namun sekarang ini sudah banyak masyarakat adat suku Sakai yang menggunakan pakaian seperti masyarakat pada umumnya.

3.3 Implementasi Nilai Filosofi dan Kearifan Lokal Masyarakat Adat Sakai Pembangunan Berkelanjutan SDGs

Tujuan SDGs memiliki enam pilar yaitu rakyat (people), planet (planet), kemakmuran (prosperity), perdamaian (peace), dan kemitraan (partnership). SDGs Desa adalah salah satu upaya yang digunakan untuk menciptakan sebuah desa tanpa kemiskinan, kelaparan dan pertumbuhan ekonomi yang merata, desa yang peduli akan kesehatan, peduli dengan lingkungan, peduli lingkungan, desa ramah dengan perempuan, desa jejaring dan tanggap budaya dalam upaya pencapaian Tujuan Pembangunan Berkelanjutan. Pembangunan berkelanjutan atau Sustainable Development Goals disingkat SDGs memiliki sifat yang umum, memberikan peran yang selaras dengan seluruh negara dan organisasi pembangunan dunia untuk menciptakan seta berkontribusi dalam upaya penciptaan tatanan masyarakat di dunia yang sejahtera dan berkeadilan.

Ada beberapa pokok yang harus diperhatikan secara lebih dalam upaya penciptaan pembangunan berkelanjutan, diantaranya dalam pengelolaan sumberdaya alam dan pengelolaan lingkungan hidup. Pengelolaan sumberdaya dengan memperhatikan kearifan lokal atau hal-hal yang berada di tengah masyarakat juga dapat menjadi upaya pencapaian pembangunan berkelanjutan. Kearifan lokal yang terdapat pada keyakinan dan kepercayaan masyarakat baik nilai dan norma yang berlaku adalah salah satu upaya dalam penciptaan pembangunan berkelanjutan.

Suku Sakai merupakan Suku dari pedalaman yang berada dipedalaman yang dicirikan sebagai komunitas yang hidup nomaden di kawasan dihutan. Kawasan tempat tinggal masyarakat Adat Sakai semakin tergusur oleh industri yang berkembang pada bidang perminyakan, usaha hutan, perkebunan karet dan perkebunan sawit. Pola kehidupan masyarakat Suku Sakai yang selalu berusaha menjaga kesimbangan hutan sehingga suku ini disebut suku penjaga hutan. Sekarang ini, hutan di Kawasan tempat tinggal masyarakat adat Sakai semakin rusak karena masyarakat sudah mulai berkurang mentaati pantangan aturan ada. Beberapa adat dan pantangan yang dianut oleh suku ini membuat suku ini terancam punah. Namun alasan lain suku ini punah adalah mereka tertinggal akan kemajuan teknologi dan tertinggal akan pengetahuan. Tertinggalnya pengetahuan dan teknologi menyebabkan mereka diremehkan dan dimanfaatkan oleh masyarakat yang tidak bertanggungjawab dan merusak alam.

SDG's merupakan sebuah gerakan yang mendorong semua pihak untuk aktif dalam berkontribusi sesuai fungsi mereka dengan kemampuan masing-masing. Kebijakan yang diciptakan oleh pemerintah pusat dan pemerintah daerah telah diselaraskan atau dilakukan penyesuaian terhadap upaya pembangunan berkelanjutan dunia (indikator SDG's). Dengan memahami beberapa indikator dapat menciptakan dorongan bagi semua pihak dalam melancarkan upaya pembangunan berkelanjutan.

Masyarakat Adat Sakai melakukan banyak pekerjaan mulai dari bertani di ladang dan mencari makanan di sekitar wilayah hutan. Ternyata masyarakat adat Sakai tidak hanya berperan sebagai pemburu, tetapi juga sebagai pedagang, pencari ikan atau nelayan, dan pengurus ladang atau petani. Walaupun sudah banyak menerima perubahan, masyarakat adat Sakai masih memiliki kaitan dengan upacara daur hidup masih sangat melekat pada kehidupan mereka sehari-hari. Suku Sakai yang memanfaatkan hasil sungai sudah sangat jarang sekali ditemui.

Kearifan lokal yang dimiliki oleh masyarakat adat Sakai selaras dengan gerakan SDG's karena memiliki beberapa kesamaan tujuan yang hendak dicapai. Hutan ulayat masyarakat Sakai dikategorikan dalam beberapa kategori yaitu: hutan adat, hutan larangan, dan hutan perladangan. Dalam pemanfaatan ketiga hutan ini memiliki perbedaan yang tidak bisa disamakan antara hutan. Hutan adat dalam pemanfaatannya hanya boleh diambil hasilnya seperti masu, rotan dan damar. Sedangkan hutan perladangan boleh ditebas dan dilakukan kegiatan bertani, yang terakhir hutan larangan yang tidak boleh diusik sama sekali oleh masyarakat suku Sakai.

Kearifan lokal yang mereka anut semakin berkurang, masyarakat terlihat hidup yang kekukrangan. Pola hidup Suku Sakai yang selalu berusaha menjaga keseimbangan ekosistem alam membuat mereka dijuluki suku penjaga hutan. Namun sekarang ini banyak hutan yang sudah digunakan untuk perusahaan minyak Walaupun masyarakat masih menjaga hutan namun banyak juga hutan yang telah dirusak orang luar. Makin rusaknya hutan dan alam serta hilangnya sejumlah pantangan atau aturan adat yang tadinya dianut, membuat suku ini terancam punah. Tradisi nomaden pun mulai ditinggalkan oleh Suku Sakai karena hutan di wilayah Riau yang makin berkurang

Tradisi nomaden pun mulai ditinggalkan oleh Suku Sakai karena hutan di wilayah Riau yang makin berkurang. Kini, kabarnya Suku Sakai tak cuma tinggal di Provinsi Riau saja. Populasi mereka sudah menyebar di berbagai daerah, seperti Jambi. Sudah banyak yang berbaur dengan orang luar yang lebih modern. Bahkan ada yang

sudah lebih maju dengan mengenyam pendidikan yang lebih layak. Tampaknya melihat kembali Suku Sakai yang bergantung pada hasil kekayaan sungai dan mencari ikan sudah sangat sulit saat ini. Pada saat ini masyarakat suku sakai sudah mengalami perubahan sebagian sudah memeluk agama Islam dan memperoleh pendidikan mulai Sekolah Dasar sampai Perguruan Tinggi. Masyarakat Suku sakai tidak hanya bekerja sebagai peramu tetapi sudah ada yang bekerja sebagai guru, pegawai negeri, pedagang, petani dan nelayan. Walaupun sudah mengalami perubahan dalam masyarakat sakai tetapi masih berkaitan dengan upacara daur hidup masih melekat dalam kehidupan mereka.

Masyarakat Adat Suku Sakai yang melakukan penebangan pohon diharuskan bahwa setiap menebang satu batang pohon harus menanam satu bibit pohon baru di sampingnya. Jual beli lahan itu dianggap aib yang akan memberi malu pada suku. Berubahnya lingkungan alam di masyarakat sakai dimana berubahnya hutan menjadi perkebunan sawit dan karet juga mempengaruhi pola pemikiran sakai dan budaya sakai, dimana masyarakat sakai sekarang disibukan dalam mengurus ekonomi keluarga. Penebangan pohon dan eksplorasi yang berlebihan membuat kehidupan Suku Sakai jadi terancam. Hidup bergantung pada alam sedangkan alam mulai rusak, jelas upaya bertahan hidup jadi makin tak mudah. Masyarakat Suku Sakai memiliki majelis suku sakai yang terkait dengan adat, sumber daya manusia, ekonomi, kerjasama dengan cefron. Masyarakat berpandangan apabila tidak melaksanakan upacara tersebut akan mendapatkan musiah menurut kepercayaan mereka yaitu akan diganggu oleh makhluk-makhluk gaib yang dinamakan antu. Suku Sakai sangat bergantung kepada alam, meskipun sebagian dari mereka sudah menerapkan pertanian dan juga berladang. Tapi, bagaimana pun juga alam adalah rumah mereka dan juga tempat mencari penghidupan. Kearifan lokal memberi dampak signifikan pada lingkungan yang menciptakan harmoni dengan alam yang merupakan salah satu tujuan dari pencapaian SDG's.

4 KESIMPULAN

Masyarakat Adat Sakai merupakan masyarakat Adat Suku yang terasing dan hidup di pedalaman. Tempat tinggal masyarakat Adat Sakai yaitu di antara perusahaan minyak cefron. Mereka hidup miskin dan memiliki penghasilan yang sangat jauh dari pendapatan masyarakat pada umumnya. Kearifsn lokal masyarakat yaitu mereka menggnakan alat-alat pertanian yang sederhana untuk bercocok tanam dan alat tersebut tidak merusak lingkungan. Melestarikan hutan dan sungai, masyarakat Sakai menerapkan sanksi yang diberikan kepada anak-kemenakan Sakai yang melakukan penebangan pohon dan pengrusakan lingkungan. jika menebang pohon ada tunggulnya maka harus diganti dengan pohon lain.

Kearifan lokal dapat dilakukan melalui keputusan pemerintah daerah atau pemerintah desa. Bentuk pengakuan tersebut selain menjaga kelestarian kearifan lokal juga menghargai perjuangan masyarakat adat yang selama ini telah berperan banyak dalam pengelolaan dan perlindungan lingkungan hidup. Sekarang ini, kehidupan masyarakat banyak yang dilakukan pelanggaran terhadap aturan adat, hutan ditebang secara sembarangan sehingga menimbulkan kerusakan.

DAFTAR PUSTAKA

- [1] Badan Lingkungan Hidup Pemerintah Provinsi Riau. 2014. *Profil Kearifan Lokal*
- [2] Chandra et al. 2005. *Manifesto Pembaharuan Desa*. Yogyakarta: APMD Press
- [3] Effendi, E. Putra, S. 2017. Kearifan Lokal Budaya Suku Sakai Terhadap Sumber Daya Perairan Di Kabupaten Bengkalis. Riau Law Journal Vol. 1 No.1, Mei 2017.
- [4] Fergus D J, Sugiharso. 1995. *Situasi dan Masalah Sumber Daya Manusia di Indonesia*. Jakarta: PT. Gramedia Pustaka Utama
- [5] Hayami dan Kikuchi. 1987. *Dilema Ekonomi Desa*. Jakarta: Yayasan obor Indonesia

- [6] Husein E. 2006. Konsep multifungsi untuk revitalisasi pertanian. *Warta Penelitian dan Pengembangan Pertanian Indonesia*. 28(5)
- [7] Isdarwanto, T., Zulfa. 2010. Suku Sakai dalam Tiga Kekuasaan di Riau. *Jurnal Ilmu Budaya* Vol.6 No.02. Hal; 1-64.
- [8] Kasriyono. 1984. *Prospek Pembangunan Ekonomi Pedesaan*. Jakarta: Yayasan Obor Indonesia
- [9] Kirkpartrick, D.L. 1998. *Evaluating training programs: The four levels*. (2nd ed). San Fransisco: Berrett-Koehler Publishers, Inc.
- [10] Mangkuprawira S. 2004. *Manajemen Mutu Sumberdaya Manusia*. Jakarta: Ghalia Indonesia
- [11] Notoatmodjo S. 1991. *Pengembangan Sumberdaya Manusia*. Jakarta: Rineka Cipta
- [12] Nasution, M.N. 2001. *Manajemen Mutu Terpadu*, Jakarta : Ghalia Indonesia
- [13] Narwoko D dan Suyanto B. 2011. *Sosiologi Teks Pengantar dan Terapan*. Jakarta: Prenada Media Group
- [14] Pareek, Udai. 1984. *Perilaku Organisasi : Pedoman Kearah Pemahaman Proses Komunikasi Antar Pribadi dan Motivasi Kerja*. Jakarta : Pustaka Binaman Pressindo.
- [15] Purnamasari, Irma. (2008) Partisipasi Masyarakat dalam Perencanaan Pembangunan (Studi di Kecamatan Cibadak Kabupaten Sukabumi) Tesis, Magister Administrasi Publik, Universitas Diponegoro Semarang.
- [16] Saputra, T., Publik, A., Riau, P., Publik, A., Riau, U., Riau, P., Mandau, C. T., & Sakai, S. (2021). *Model Penguatan Modal Sosial Pembangunan Budaya Dan Kearifan Lokal Suku Sakai Kabupaten Bengkalis*. 3, 147–158.
- [17] Setiadi et al. 2008. *Ilmu Sosial dan Budaya Dasar*. Jakarta: Kencana Prenada Group
- [18] Suhana, *Pengakuan Keberadaan Kearifan Lokal Lubuk Larangan Indarung, Kabupaten Kuantan Singingi Provinsi Riau Dalam Pengelolaan dan Perlindungan Lingkungan Hidup*, *Jurnal Centre for Ocean Development and Maritime Civilization Studies*, 2008

- [19] Soekanto S. 1986. *Pengantar Penelitian Hukum*. Jakarta: UI Press
- [20] Soekanto S. 2009. *Sosiologi Suatu Pengantar*. Jakarta: Rajawali Pers
- [21] Soetomo. 2012. *Pembangunan Masyarakat*. Jakarta: Pustaka pelajar
- [22] Subadio M U dan Ihromi. 1994. *Peranan dan Kedudukan Wanita Indoneisa*. Yogyakarta: Gadjah Mada University Press.
- [23] Sunarto K. 1984. *Pengantar Sosiaologi*. Jakarta: Yayasan Obor Indonesia
- [24] Wardiyanta, Hidayat, M.H., Adilla, M.F., 2020. Pemanfaatan Potensi Alam dan Kearifan Lokal Untuk Mendukung Promosi Pariwisata Kreatif Sleman Yogyakarta. Semnas "Pengelolaan Sumber Daya Alam Berkesinambungan Di Kawasan Gunung Berapi".

BIOLOGICAL ASPECT OF HUMAN INTELLIGENCE: ANATOMY, CELL BIOLOGY, AND MOLECULAR BIOLOGY

ASPEK BIOLOGIS PADA KECERDASAN MANUSIA: TINJAUAN ANATOMI, BIOLOGI SEL, DAN MOLEKULER

**Fawzi R. Zuhairi¹, Sri Utami², Heny Kurniawati³,
Mutimanda Dwisatyadini⁴, Raflen Aril Gerungan⁵**

*Program Studi Biologi, Jurusan Matematika dan Ilmu Pengetahuan
Alam, Fakultas Sains dan Teknologi,
Universitas Terbuka (INDONESIA)
fawzi.zuhairi@ecampus.ut.ac.id*

Abstract

Brain is the most important organ for human intelligence. However, its efficiency for information processing is varied among individuals. Unraveling the biological basis of the speed of information processing in human is one of the main topics in neuroscience. Currently, there are two methods in studying human intelligence in neuroscience: brain imaging study for identifying areas in brain- and genetic study for determining genes and loci- involved in intelligence. Despite many technological advancements in biology, it is not well defined exactly the biological mechanisms of the brain related to human intelligence. The emergence of transcriptomic and cellular neuroscience studies provides alternative methods to determine the link between genes and brain structure, as well as its function with individual intelligence. In this article, we will discuss the latest studies in biological mechanisms related to human intelligence: 1. Population of brain cells related to intelligence, 2. How various specific genes able to produce cellular properties related to intelligence, and more importantly can further explain the relationship between brain structure and function involved in intelligence, 3. Recent advances in neuroscience research on a

cellular scale, which may explain the biological basis that bridges the understanding between genetics and physiology in certain areas of brain that are thought to have a role in individual intelligence.

Keywords: intelligence, brain anatomy, genetics of intelligence, neuron, pyramidal cell

Abstrak

Dalam ilmu neurobiologi, otak merupakan organ utama yang berperan dalam kecerdasan. Otak pada beberapa individu bersifat lebih efisien dalam bekerja apabila dibandingkan individu lain. Pemahaman fondasi biologis pada berbagai jenis kemampuan dan kecepatan memproses informasi yang dimiliki oleh otak pada berbagai individu manusia merupakan salah satu topik yang sangat penting pada bidang ilmu neurosains. Terdapat dua jenis metode penelitian pada bidang neurosains yang banyak digunakan: (1) studi pencitraan otak (*brain imaging study*), yang mempelajari tentang struktur otak dalam skala mikroskopik beserta fungsinya untuk mengidentifikasi area pada otak yang berperan dalam kecerdasan manusia; (2) studi skala genetika yang bertujuan untuk mengetahui gen serta lokus gen mana yang berperan dalam kecerdasan manusia. Meskipun dengan kemajuan metode dan teknologi di bidang biologi, hingga saat ini belum diketahui secara pasti komponen apa pada otak yang berkaitan dengan kecerdasan manusia. Munculnya studi transkriptomik dan neurosains seluler (*cellular neuroscience*) memberikan strategi alternatif untuk mengetahui kaitan antara gen serta struktur dan fungsi otak dengan kecerdasan individu. Pada artikel ini akan didiskusikan mengenai perkembangan terkini dalam hal memahami mekanisme biologis yang berkaitan dengan kecerdasan manusia: 1. Studi populasi spesifik pada sel otak yang berkaitan dengan kecerdasan, 2. Bagaimana berbagai gen spesifik menghasilkan *cellular properties* yang berkaitan dengan kecerdasan serta dapat menjelaskan struktur dan fungsi pada area otak yang terlibat dalam kecerdasan tersebut. 3. Pentingnya riset neurosains dalam skala seluler yang menjadi landasan konsep yang menjembatani pemahaman antara lingkup

genetika dengan fisiologi pada area otak yang diduga dapat berperan dalam kecerdasan individu.

Kata Kunci: Kecerdasan, Anatomi Otak, Genetika Kecerdasan, Sel Piramidal, Sel Neuron

1 PENDAHULUAN

1.1 Definisi Dari Kecerdasan Pada Manusia

Sebagian dari kita telah mengetahui bagaimana cara menjadi manusia yang cerdas, atau sudah merasa menjadi individu yang cerdas, atau ingin menjadi manusia yang cerdas. Namun demikian, definisi dari kecerdasan dapat memiliki arti yang luas. Kecerdasan mencakup hal sebagai berikut: sesuatu yang membantu kita melakukan rencana, berpikir logis, menyelesaikan masalah, mampu belajar dengan cepat, mengambil keputusan, dan yang paling utama adalah, *survive* pada dunia modern ini. Untuk mendapatkan sifat cerdas, digunakanlah tes kognitif untuk mengukur kemampuan pada beberapa domain kognitif, seperti kecepatan dalam berpikir (*processing speed*) dan berbahasa. Selanjutnya, riset menunjukkan bahwa hasil dari berbagai jenis tes kognitif bersifat sangat berkorelasi antara satu dengan yang lainnya, sehingga menghasilkan faktor yang mewakili berbagai jenis kemampuan manusia, yang disebut dengan *general intelligence* atau Spearman's *g* (Spearman, 1904). Salah satu jenis tes yang digunakan untuk mengestimasi nilai Spearman's *g* adalah *Wechsler Adult Intelligent Scale* (WAIS). Jenis tes ini menggabungkan berbagai uji kognitif ke dalam satu pengukuran, yakni berupa nilai IQ.

Apakah tes ini dapat mengukur kecerdasan manusia secara valid? Dan apakah engan memberikan angka/skala kecerdasan dalam suatu nilai tunggal (yakni nilai IQ) adalah metode yang relevan? Berbagai penelitian menunjukkan bahwa tes tersebut terbukti validitas dan relevansinya. Pertama, hasil terhadap tes IQ sangat berkorelasi kuat dengan kehidupan yang didapat, termasuk status sosial ekonomi dan kemampuan kognitif, bahkan ketika diukur dari kehidupan awal individu manusia (Foverskov et al., 2017). Semakin tingginya kompleksitas dan masyarakat yang bergantung dengan teknologi maka semakin penting kemampuan kognisi pada manusia dalam hampir seluruh aspek kehidupan manusia. Kecerdasan yang tinggi

dapat memberikan banyak manfaat yang bila dibayangkan mungkin bersifat tidak signifikan, namun apabila terakumulasi maka dapat meningkatkan kualitas hidup individu (Gottfredson, 1997). Hal ini dapat memberikan keunggulan diantaranya pada status sosial ekonomi, pendidikan, mobilitas sosial, performa pekerjaan, dan bahkan gaya hidup dan usia hidup (Lam et al., 2017).

Kedua, penelitian menunjukkan bahwa kecerdasan bersifat stabil, yakni dimiliki dari usia muda hingga tua pada individu yang sama. Pada studi skala besar terhadap anak-anak di Inggris, terdapat korelasi antara nilai 0.81 pada kecerdasan anak yang didapat ketika berusia 11 tahun dengan hasil ujian nasional pada tempat sekolahnya 5 tahun kemudian (Deary et al., 2007). Bahkan pada usia lanjut, kecerdasan tetaplah bersifat stabil. Satu jenis tes mengenai kecerdasan umum (*general intelligence*) yang dilakukan pada individu berusia 11 tahun sangat berkorelasi dengan hasil tes yang sama pada usia 90 tahun (Deary et al., 2013).

Ketiga, salah satu hal yang paling menarik adalah hasil riset menunjukkan bahwa peran heritabilitas pada kecerdasan adalah sangat besar, yakni dalam proporsi 50% hingga 80%, bahkan mencapai 80% untuk IQ pada aspek verbal (Posthuma et al., 2001). Hal ini menyebabkan kecerdasan manusia adalah salah satu sifat perilaku manusia yang paling sangat memungkinkan untuk diturunkan dari satu generasi ke generasi selanjutnya. Selain itu, perkawinan campur (*assortative mating*) dapat menambahkan varian genetik tambahan pada populasi serta berkontribusi terhadap tingginya sifat heritabilitas ini (Plomin dan Deary, 2015).

Meskipun masih banyaknya versi definisi terhadap “kecerdasan manusia”, sifat tersebut adalah salah satu pembeda individu yang penting di antara manusia. Hal tersebut dapat diukur dengan uji kognitif, dan hasil terhadap tes tersebut telah menunjukkan validitas dan relevansinya. Pengukuran kecerdasan bersifat stabil sepanjang waktu, memiliki heritabilitas tinggi, dan dapat memberikan kualitas hidup yang lebih baik.

1.2 Morfologi Dan Anatomi Otak Manusia

Sistem saraf pusat (central nervous system) terdiri dari beberapa komponen (gambar 1). Pada saraf spinal merupakan bagian yang bersifat paling kaudal pada sistem saraf pusat, dan berfungsi untuk menerima dan memproses informasi sensory (sensory information) dari kulit, joints, dan otot dari torso serta tangan dan kaki dan untuk menggerakkan anggota tubuh tersebut. Sistem saraf spinal terbagi menjadi *cervical*, *thoracic*, *lumbar*, dan *sacral*.

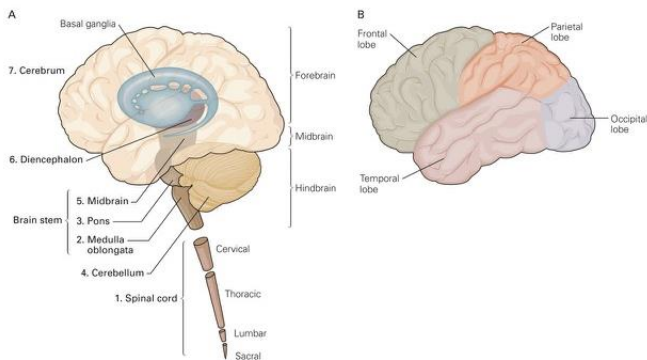

Gambar 1. Sistem Saraf Pusat

Pada batang otak (brain stem), terdiri dari medulla oblongata, pons, dan midbrain (otak tengah). Batang otak menerima informasi sensori dari kulit dan otot pada kepala, dan berfungsi untuk kontrol motorik pada sistem otot di kepala. Selain itu, brain stem juga berfungsi untuk convey (menyampaikan) informasi dari sistem saraf spinal ke otak dan juga sebaliknya, dan bertanggung jawab terhadap sifat kesadaran manusia.

Pada diencephalon terdapat dua struktur: thalamus yang berfungsi untuk memproses sebagian besar informasi yang terkumpul/tiba di korteks serebral dari seluruh sistem saraf pusat, dan hipotalamus yang berfungsi untuk fungsi regulasi gerakan autonomik, endokrin, dan visceral (fungsi homeostasis).

Pada area serebrum, terdiri dari dua hemisfer serebral, yakni cerebral cortex yang memiliki struktur lapisan luar yang berkerut-kerut (dan dibagi menjadi empat lobus yakni lobus frontal, parietal, occipital, dan temporal; selain itu, cerebral cortex berperan besar dalam aspek kognisi manusia, yang akan dibahas pada beberapa paragraf selanjutnya), dan tiga struktur yang terdapat/berlokasi/tertanam di bagian dalam serebrum, yakni basal ganglia (berperan dalam regulasi aktivitas motorik), hipocampus (berperan dalam penyimpanan memori pada otak), dan amygdaloid nuclei (berperan dalam koordinasi respon autonomik dan endokrin pada aspek emosional manusia).

1.3 Struktur Dan Fungsi Sel Neuron

Kemampuan sel neuron untuk menerima dan mentransmisikan informasi adalah berdasarkan organisasi seluler yang bersifat spesifik (*highly specialized*) (Gambar 48.2). Sebagian besar organel pada neuron, termasuk inti sel, berada pada sel tubuh (*cell body*). Tipe sel neuron umumnya memiliki berbagai perpanjangan atau cabang yang disebut dengan dendrit, dan dendrit ini (bersama dengan sel tubuh) memiliki fungsi untuk menerima sinyal dari neuron lainnya. Neuron juga memiliki akson tunggal, yakni struktur perpanjangan yang berfungsi untuk transmisi sinyal ke sel lainnya.

Not used: Akson biasanya berukuran jauh lebih panjang daripada dendrit: seperti pada jerapah, memiliki akson yang menghubungkan sistem saraf pusat ke sel otot pada kakinya sepanjang lebih dari satu meter. Pada bagian basal akson yang berbentuk seperti *cone*, atau disebut juga axon hillock, biasanya merupakan tempat dimana terbentuknya sinyal yang melalui *travel down the axon*. Pada bagian ujung, biasanya axon terbagi menjadi beberapa cabang.

Setiap cabang pada bagian akhir pada akson berfungsi untuk mentransmisikan informasi ke sel lainnya pada celah/junction yang disebut dengan sinaps (gambar 48.2), dan bagian dari setiap cabang dari akson yang membentuk gap/celah ini disebut dengan *synaptic terminal* atau terminal sinaptik. Pada sebagian besar sinaps, senyawa kimia (*chemical messengers*) yang disebut dengan neurotransmitter

meneruskan informasi dari *transmitting neuron* ke sel penerima. Pada istilah neurosains untuk area sinaps ini, kita menyebut area yang mentransmisikan neuron sebagai *presynaptic cell*, dan neuron, otot, atau sel kelenjar yang menerima sinyal ini disebut sebagai *postsynaptic cell*.

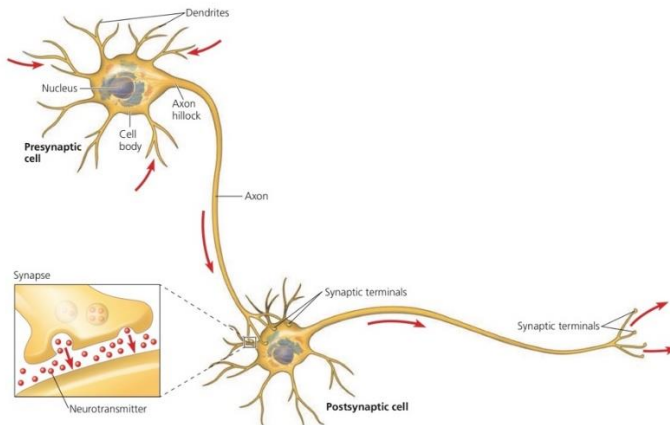

Gambar 2. Struktur Neuron

Neuron pada vertebrata dan sebagian besar invertebrata membutuhkan sel penyokong yang disebut dengan sel glial atau glia (Gambar 2). Glia berfungsi untuk memberikan nutrisi pada neuron, insulate axon pada neuron, dan regulasi cairan ekstraseluler di sekitar neuron. Secara umum, jumlah glia pada otak mamalia mencapai 10x hingga 50x lebih banyak daripada neuron.

2 PEMBAHASAN

2.1 Studi Anatomi Pada Otak Dan Pengaruhnya Terhadap Kecerdasan Manusia

Studi *neuroimaging* (pencitraan otak) menunjukkan bahwa kecerdasan umum didapat tidak hanya bergantung pada satu daerah otak saja. Kecerdasan tersebut didukung oleh *network* atau jaringan

yang terdistribusi pada bagian otak yang kebanyakan berada pada daerah korteks yang berasosiasi dengan aspek orde tinggi (*higher-order association cortices*), atau dikenal dengan area network parietal-frontal (Gambar 1). Daerah yg termasuk dalam network tersebut diantaranya: korteks dorsolateral prefrontal, lobus parietal, anterior *cingulate*, beberapa daerah pada lobus temporal dan occipital, dan *white matter tracts*. Berdasarkan berbagai hasil riset, pembagian area otak yang bertanggung jawab jenis kecerdasan tertentu terdiri dari: (1) Area lobus frontal dan parietal berperan pada *fluid intelligence*, yakni jenis kecerdasan berupa penalaran umum, kemampuan untuk mempelajari hal baru, dan berpikir secara abstrak serta memberikan solusi atas suatu permasalahan; (2) Lobus temporal memiliki kaitan dengan *crystallized intelligence*, yakni jenis kecerdasan yang berasal dari pembelajaran terhadap pengalaman atau proses belajar yang pernah dilakukan sebelumnya; dan (3) *White matter integrity* berasosiasi dengan hal *processing speed*, yang artinya adalah kemampuan dan kecepatan seorang individu untuk menerima suatu informasi baru, lalu memberikan penilaian (*judgement*), hingga merumuskan tanggapan terhadap hal tersebut (Goriounova dan Mansvelder, 2018).

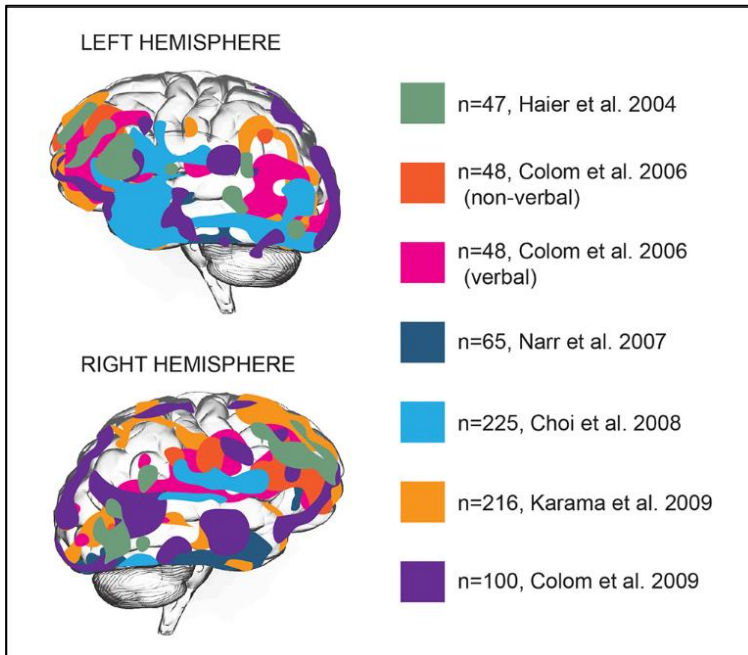

Gambar 3. Ketebalan substansi abu (gray matter) pada berbagai area korteks yang berasosiasi dengan kecerdasan umum. Area pada otak dengan korelasi yang tinggi antara ketebalan korteks dengan kecerdasan umum direpresentasikan dengan warna yang berbeda disertai dengan literatur yang relevan. Sumber: Goriounova dan Mansvelder, 2018.

Meskipun studi pencitraan otak telah mengidentifikasi korelasi antara anatomi dan fungsi otak terhadap kecerdasan manusia, namun riset menunjukkan bahwa hasil koefisiensi korelasi nya memiliki nilai yang normal, yakni hanya berkisar 0.15 – 0.35 (Hulshoff Pol et al., 2006; Narr et al., 2007; Choi et al., 2008; Karama et al., 2009). Terdapat beberapa kemungkinan terkait dengan hal ini. Namun, pengukuran kecerdasan manusia tersebut tidak akan dapat dipahami secara komprehensif apabila hanya dilakukan pengukuran terhadap

struktur dan fungsi otak yang teraktivasi pada area korteks menggunakan MRI (*magnetic resonance imaging*). Tentunya terdapat faktor lainnya yang bisa berperan dalam kecerdasan manusia. Bila kita melihat dalam perspektif evolusi, otak manusia memiliki kemampuan kognitif yang luar biasa bila dibandingkan dengan spesies lainnya, contohnya dalam kecerdasan fundamental seperti berpikir, kemampuan berbahasa, dan berkreativitas. Namun, anatomi pada otak manusia tidak terlalu berbeda apabila dibandingkan dengan spesies mamalia lainnya, sehingga aspek pengukuran struktur dan fisiologi otak terhadap kecerdasan menggunakan MRI tersebut tidak akan bisa menjelaskan secara keseluruhan mengenai bagaimana bisa terjadi loncatan kecerdasan yang tinggi atau adanya jarak/*gap* diantara manusia dan spesies kerabat lainnya (Goriounova dan Mansvelder, 2018).

Dalam hal ukuran dan jumlah neuron, ukuran otak manusia bukanlah yang terbesar apabila dibandingkan dengan spesies mamalia lainnya: otak pada gajah dan paus memiliki ukuran yang lebih besar (Manger et al., 2013). Selain itu, jumlah korteks pada ikan paus bersirip panjang (*long-finned pilot whale; Globicephala melas*) memiliki lebih banyak neuron daripada manusia, dengan perbandingan 37 triliun vs 20 triliun (Pakkenberg and Gundersen, 1997; Mortensen et al., 2014). Apabila dibandingkan dengan otak yang dimiliki oleh kerabat terdekat manusia secara evolusi, yakni primata non-manusia, studi menunjukkan adanya kemiripan yang sangat tinggi. Secara ukuran dan anatomi, otak pada manusia hanya berukuran sedikit lebih besar bila dibandingkan dengan primata. Selain itu, studi menunjukkan tidak adanya ciri anatomi dan fisiologi yang menjadi pembeda pada area otak yang berperan dalam kemampuan kognitif antara manusia dengan kelompok primata lainnya (Goriounova dan Mansvelder, 2018).

Berdasarkan berbagai riset pada bidang neurosains yang telah dijelaskan pada paragraf sebelumnya, maka untuk mengetahui mekanisme biologis yang berperan dalam kecerdasan manusia serta variasi yang ada antar individu tidak cukup hanya dengan melakukan

studi pada aspek anatomi saja (*gross anatomy*), namun juga dibutuhkan pemahaman terhadap mekanisme dari level molekuler dan unit komputasional yang terdiri dari: neuron, sinaps, dan gen-gen yang terlibat di dalamnya.

2.2 Studi Genetik Mengenai Kecerdasan Manusia

Kecerdasan manusia merupakan salah satu karakteristik yang diturunkan secara temurun (*heritability traits*). Studi pada individu kembar identik menunjukkan bahwa faktor genetik memiliki peran sebesar 50-80% terhadap kecerdasan manusia. Namun demikian, riset *genome-wide association studies* atau GWAS hanya mampu mengidentifikasi sekitar 20% dari seluruh gen yang diturunkan ini (Lam et al., 2017; Trampush et al., 2017; Savage et al., 2018; Coleman et al., 2019). Aspek yang diduga dapat mempengaruhi tingkat kecerdasan individu adalah akibat dari aktivitas atau regulasi berbagai jenis gen atau *sequence* DNA tertentu, yaitu sekitar 95% varian genetik terdapat pada area DNA *non-coding* (intronik dan intergenik) pada genom manusia (**Gambar 2**). Sementara itu, hanya sejumlah kecil *single-nucleotide polymorphisms* (SNPs; 1.4%) yang terletak pada area DNA yang mengkode protein (**Gambar 2**).

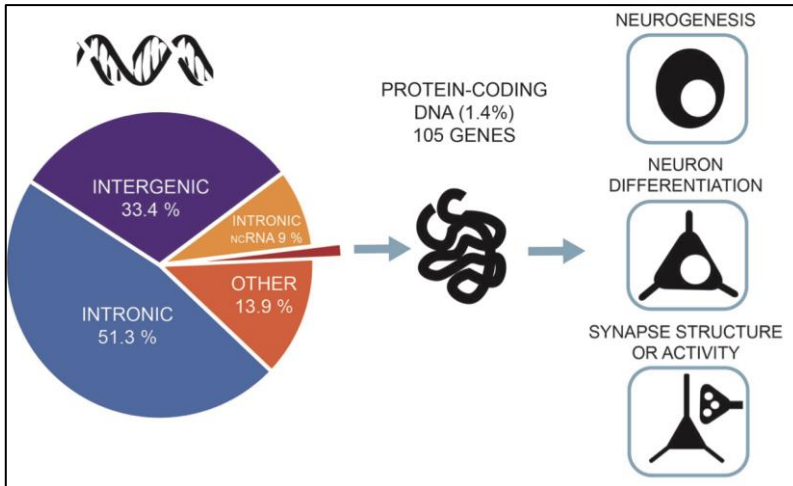

Gambar 4. Sebagian besar varian genetik yang diduga berkaitan dengan kecerdasan berada pada area DNA non-coding, sementara hanya 1.4% dari single-nucleotide polymorphisms (SNPs) merupakan DNA exon dan mengkode protein. Gambar ini dimodifikasi dari studi GWAS oleh Savage et al., 2018. Sumber: Goriounova dan Mansvelde, 2018.

Mayoritas gen yang berkaitan dengan kecerdasan memiliki peran dimulai dari perkembangan janin atau prenatal. Beberapa gen tersebut yang berfungsi dalam proses sinaptik dan plastisitas (*plasticity*) tetap memiliki regulasi sepanjang hidup individu. Studi menunjukkan bahwa beberapa karakteristik seperti perbandingan panjang dengan berat badan kelahiran (*birth length/weight*) dan usia yang panjang berkorelasi tinggi dengan kemampuan kognitif (Lam et al., 2017; Trampush et al., 2017). Hal ini menunjukkan bahwa kesehatan umum seseorang merupakan syarat untuk dapat memiliki fungsi kognitif yang optimal.

Studi GWAS memungkinkan kita untuk mengetahui kemungkinan adanya hubungan antara gen dan fenotipe pada individu. Namun, studi transkriptomik pada jenis sel dan jaringan pada otak post-

mortem manusia telah memberikan wawasan baru untuk hasil studi GWAS. Dengan menghubungkan hits antara data GWAS dengan data transkriptomik pada sel dan jaringan tertentu (studi GTEx) dapat diperkirakan pada daerah otak atau bahkan hingga tipe sel manakah yang dapat mengekspresikan gen yang berpotensi terlibat dalam kecerdasan manusia (Ardlie et al., 2015). Namun satu hal yang perlu diperhitungkan adalah, karena gen yang berkaitan dengan kecerdasan tidak harus diekspresikan pada waktu perkembangan biologis yang sama, dan juga karena lokus otak yang terlibat dalam kecerdasan tersebar secara luas, maka tidak semua gen harus diekspresikan pada area otak atau tipe sel yang sama. Namun demikian, dengan menggunakan metode ini, ditemukan bahwa gen yg berkaitan dgn pencapaian pendidikan dan kecerdasan cenderung untuk diekspresikan secara bersamaan pada jaringan syaraf, terutama pada bagian seperti hipokampus, otak tengah, dan korteks frontal. Bagian ini menunjukkan perbanyakan ekspresi gen yang paling tinggi (Savage et al., 2018; Coleman et al., 2019). Kecuali pada area otak tengah, area otak lainnya tersebut telah diketahui berperan dalam kecerdasan individu melalui studi pencitraan otak.

Profil ekspresi gen pada sel tertentu untuk studi mengenai gen yang berperan dalam kecerdasan menunjukkan pentingnya peran sel neuron. Analisis lebih lanjut pada tipe sel neuron menunjukkan adanya *enrichment* yang signifikan pada gen tersebut di neuron piramidal pada area hipokampus CA1 dan area korteks somatosensori Meskipun sel glia merupakan tipe sel yang paling banyak dalam otak manusia (Vasile et al., 2017), belum ditemukan bukti adanya perbanyakan atau *enrichment* pada kandidat gen tersebut pada oligodendrosit atau astrosit (Lam et al., 2017; Trampush et al., 2017), sehingga hanya neuron yang diduga memiliki peran utama pada variasi genetik tersebut.

Selain itu, hubungan yang signifikan juga ditemukan pada tipe sel prinsipal pada area striatum, yaitu *medium spiny neurons* (Savage et al., 2018; Coleman et al., 2019). Neuron piramidal merupakan tipe neuron yang sangat banyak pada daerah neokorteks dan

hipokampus., imana Kedua area tersebut bertanggung jawab atas fungsi eksekutif tingkat tinggi (*higher executive functions*), contohnya seperti dalam hal pengambilan keputusan, pemecahan masalah, dan ingatan atau memori. area striatum otak didominasi oleh tipe neuron *medium spiny* hingga 95%. Tipe neuron tersebut berfungsi dalam hal motivasi, rasa kepuasan atas suatu prestasi atau *reward*, dan perilaku belajar (Volkow et al., 2017). Hasil studi GWAS memunculkan hipotesis tentang apakah tipe neuron piramidal ini berperan penting dalam meningkatkan intelligen individu (Coleman et al., 2019). Selain itu, perlu diketahui apakah terdapat bukti bahwa substansi khusus lainnya pada sel otak dapat berperan dalam kecerdasan manusia.

2.3 Sel-Sel Yang Berperan Dalam Kecerdasan

Semenjak Ramon Cajal memberikan teori atau postulat mengenai doktrin neuron bahwa seluruh aktivitas yang melibatkan fungsi otak adalah peran dari sel neuron (Cajal, 1893), maka ilmuwan neurosains berpendapat bahwa dasar dari kecerdasan manusia terletak pada neuron atau network dari neuron-neuron yang ada pada otak. Namun demikian, studi neurosains untuk memahami mekanisme biologis pada kecerdasan manusia banyak difokuskan pada studi otak pada tingkat makroskopik dan mekanisme genetiknya, sehingga terjadi kurangnya studi tingkat seluler (Goriounova dan Mansvelder, 2018). Berdasarkan estimasi pada hasil riset, pikiran kita berfungsi melalui aktivitas dari 86 triliun neuron yg ada pada otak kita (Herculano-Houzel, 2012), dan koneksi atau hubungan tersebutlah yang berperan sebagai dasar pada proses pengkodean dan penyimpanan informasi pada otak, hingga pada akhirnya menghasilkan kemampuan kognisi (Salinas and Sejnowski, 2001). Dengan sangat besarnya jumlah network dan interkoneksi neuron (Drachman, 2005), maka sedikit perubahan pada efisiensi proses informasi pada neuron dapat menyebabkan perbedaan besar pada kemampuan kognitif individu. Namun demikian, sangat sedikit riset yang menginvestigasi bagaimana aktivitas dan struktur dari sel neuron manusia dapat

mempengaruhi kecerdasan manusia dan seberapa cepat pemrosesan informasi dipengaruhi oleh sel-sel pada otak.

Kurangnya riset bidang neurosain yang terfokuskan dalam aspek sel neuron tidaklah mengejutkan. Akses ke sel neuron pada otak manusia yang hidup sangatlah terbatas dan sebagian besar yang telah diketahui tentang fungsi neuron didapat dari penelitian terhadap hewan. Selama beberapa dekade terakhir, penggunaan jaringan sayatan otak yang didapat dari proses operasi otak atau neuron (*neurosurgical treatment*) pada pasien epilepsi atau tumor telah membuka sudut pandang baru untuk mempelajari otak manusia pada skala seluler (Testa-Silva et al., 2014; Verhoog et al., 2016). Untuk memperoleh akses pada struktur otak dalam, dokter bedah otak memotong neokorteks non-patologis yang menutupi otak (*overlying non-pathological neocortex*) dan selanjutnya jaringan tersebut dibawa ke laboratorium untuk studi lanjut. Dengan mengkombinasikan dengan tes kognitif sebelum operasi, metode ini memberikan kemungkinan untuk mempelajari fungsi neuronal yang berkaitan dengan kecerdasan manusia. Dengan menggunakan jaringan otak manusia segar atau hidup, maka hal ini tidak dapat digantikan dengan metode atau teknik lainnya. Contohnya adalah studi dengan jaringan *post-mortem* yang tidak cocok untuk studi fisiologis (Kramvis et al., 2018), sementara itu metode pencitraan otak memiliki kelemahan berupa kurang presisinya pengamatan biologis hingga skala seluler.

2.3.1 Peran Penting Sel Neuron Piramidal (Pyramidal Neuron)

Studi genetik menunjukkan bahwa ekspresi gen yg berkaitan dengan kecerdasan terakumulasi pada korteks neuron piramidal (Savage et al., 2018; Coleman et al., 2019). Perbandingan aspek atau karakteristik seluler yang penting pada neuron piramidal di beberapa spesies dapat memberikan gambaran mengenai pentingnya peran neuron tersebut pada kemampuan kognisi manusia. Bahkan jaringan otak manusia yang digunakan dalam penelitian selalu didapat dari area yang berasosiasi dengan orde tinggi (*higher-order association areas*), seperti pada korteks temporal, sehingga dapat

mempertahankan fungsi sensor primer dan kemampuan berbahasa pada pasien. Area otak inilah yang juga banyak digunakan dalam studi pencitraan otak tentang kecerdasan manusia. Properti manakah dari neuron piramidal pada korteks temporal manusia yang unggul bila dibandingkan diantara spesies lainnya?

Pertama, struktur sel piramid pada manusia berbeda (Elston dan Fujita, 2014), yakni apabila dibandingkan dengan hewan kelompok rodensia dan *macaca*, maka 2/3 dari sel piramid manusia memiliki ukuran tiga kali lebih besar dan dendrit yang lebih kompleks (Mohan et al., 2015). Selain itu, dendrit yang berukuran besar ini juga menerima dua kali lebih banyak sinaps bila dibandingkan dengan neuron piramid hewan kelompok rodensia (DeFelipe et al., 2002). Selain dalam hal perbedaan struktur, neuron piramid manusia juga menunjukkan properti fungsional yang unik. Sinaps eksitatori manusia mengalami *recovery* hingga 3x atau 4x lebih cepat apabila dibandingkan dengan sinaps pada korteks rodensia, serta memiliki potensial aksi dan transfer informasi yang lebih cepat hingga 9x apabila dibandingkan dengan tikus atau mencit (Testa-Silva et al., 2014). Selain itu, neuron manusia dewasa dapat mengasosiasikan kejadian sinaptik dalam *temporal window* yang lebih besar untuk plastisitasnya (Testa-Silva et al., 2014; Verhoog et al., 2016). Perbedaan karakteristik neuron piramidal di antara spesies inilah yang mungkin dapat menjelaskan adanya tekanan evolusi pada struktur dendrit dan fungsi neuron pada lobus temporal dan menekankan terjadinya adaptasi spesifik pada sel piramidal manusia dalam aspek fungsi kognitif yang melibatkan area pada otak ini.

Neuron yang lebih besar berkaitan dengan kecerdasan. Berdasarkan beberapa penelitian terakhir, perbedaan pada fungsi dan struktur neuron piramidal manusia memiliki kaitan dengan tingkat kecerdasan dan struktur anatomi pada lobus temporal (Goriounova et al., 2018; **Gambar 3**). Hasil riset menunjukkan bahwa nilai IQ yang lebih tinggi berkaitan dengan ketebalan korteks temporal besar pada pasien yang mengalami operasi otak dan juga individu yang sehat (Choi et al., 2008). Selain itu, korteks temporal yang lebih tebal juga

berkaitan dengan neuron piramid manusia yang lebih besar dan kompleks dendritnya. Penggabungan morfologi dendrit secara *real-time* ke dalam model komputasi menunjukkan bahwa model neuron yang lebih besar mampu memproses input sinaptik dengan akurasi temporal yang lebih tinggi. Meningkatnya transfer informasi oleh model neuron ini dikarenakan potensial aksi yang lebih cepat pada sel yang lebih besar. Selain itu, seperti yang diprediksikan pada model, rekaman eksperimen pada *potential spiking* pada neuron piramidal manusia menunjukkan bahwa individu dengan skor IQ yang lebih tinggi dapat mempertahankan potensial aksi yang cepat pada aktivitas neuronal. Penemuan ini adalah bukti pertama bahwa kecerdasan manusia berhubungan dengan neuron yang lebih besar dan kompleks, serta potensial aksi yang lebih cepat dan juga transfer sinaptik informasi yang lebih efisien (Goriounova et al., 2018).

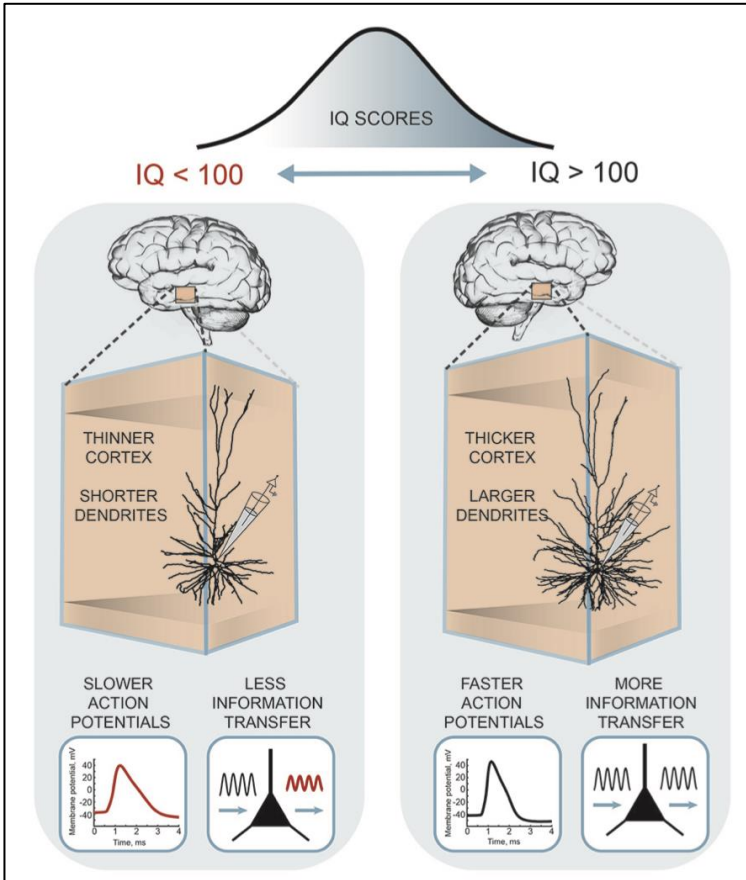

Gambar 5. Hipotesa mengenai fenomena skala seluler yang mempengaruhi kecerdasan manusia. Penelitian menunjukkan bahwa nilai IQ yang tinggi berkaitan dengan dendrit yang berukuran besar, potensial aksi yang berlangsung lebih cepat pada aktivitas neuron, serta proses informasi yang efisien pada neuron piramidal di korteks temporal. Gambar ini dimodifikasi dari hasil riset Goriounova et al., 2018.

2.4 Menghubungkan Beberapa Aspek Biologis Pada Kecerdasan Manusia: Gen, Sel, Network, Dan Area Pada Otak

Dendrit yang lebih besar mampu memproses informasi yang lebih banyak. Sel piramidal, terutama pada lapisan superfisial di area *multimodal integration* seperti pada korteks temporal atau frontal, merupakan integrator dan akumulator utama dalam informasi sinaptik. Dendrit yang berukuran besar dapat memiliki kontak sinaptik lebih banyak, sehingga mampu memproses informasi lebih banyak pula. Bahkan, dendrit pada neuron piramidal manusia menerima dua kali lebih banyak sinaps dibandingkan pada rodensia (DeFelipe *et al.*, 2002). Semakin meningkatnya kapasitas integrasi informasi pada area otak ini juga tercerminkan pada gradien kompleksitas dari sel piramidal sepanjang area korteks. Sel neuron memiliki dendrit yang berukuran lebih besar pada area yang terlibat dalam *critical processing* orde tinggi (Jacobs *et al.*, 2001; Elston and Fujita, 2014; van den Heuvel *et al.*, 2015). Baik pada manusia maupun primata lainnya, konektivitas atau hubungan antar korteks pada otak berkorelasi secara positif dengan ukuran dendrit pada sel piramidal (Scholtens *et al.*, 2014; van den Heuvel *et al.*, 2015).

Karakteristik sel dendritik pada neuron manusia bila dibandingkan dengan spesies primata lainnya adalah ukuran yang lebih panjang dan besar, serta adanya elongasi pada daerah basal di dendritik terminal (Deitcher *et al.*, 2017), sehingga sel tersebut dapat memanfaatkan setiap cabang dendritiknya sebagai kompartemen komputasi yang bersifat independen. Penelitian oleh Eyal *et al.*, (2016 dan 2018) memberikan wawasan baru dalam aspek pemrosesan sinyal dan kemampuan komputasi pada sel piramidal manusia dengan menguji detail pemodelan mereka, termasuk sinaps eksitatori, dendritik *spines*, dendritik NMDA- (N-metil-D-aspartat) dan somatik *spikes* (Eyal *et al.*, 2018). Hasil dari penelitian tersebut menunjukkan bahwa secara khusus, dendrit basal jumlah yang besar pada sel piramidal manusia serta elongasi pada bagian terminalnya, bila dibandingkan dengan spesies lainnya, menyebabkan terjadinya *electrical decoupling* pada basal terminal diantara satu neuron dengan

neuron piramidal lainnya. Pada penelitian lainnya (Beaulieu-Laroche *et al.*, 2018), hasil serupa juga ditemukan melalui metode perekaman dendritik pada neuron piramidal manusia lapisan. Apabila dibandingkan dengan korteks temporal pada tikus, dendrit pada manusia dapat berfungsi sebagai beberapa subunit semi-independen dan menghasilkan lebih banyak *spikes* dendritik NMDA yang berfungsi secara independen dan simultan (Eyal *et al.*, 2014).

Dendritik *spike* melalui reseptor NMDA merupakan komponen penting untuk komputasi yang relevan secara biologis pada neuron. Pada mencit, manipulasi pada *spikes* ini menyebabkan berkurangnya kemampuan selektivitas orientasi terhadap pemrosesan informasi visual pada neuron (Smith *et al.*, 2013). Selain itu, dendrit yang besar juga memiliki pengaruh terhadap eksitabilitas sel (Vetter *et al.*, 2001; Bekkers dan Hausser, 2007). Peningkatan ukuran kompartemen dendritik secara *in silico* menyebabkan akselerasi potensial aksi pada fasa awal dan meningkatkan kemampuan mengkode informasi pada neuron. Selain itu, bila dibandingkan dengan tikus, neuron piramidal manusia pada lapisan superfisial menunjukkan aktivasi aliran listrik yang mengalami hiperpolarisasi yang lebih tinggi sehingga dapat yang memfasilitasi eksitabilitas pada sel ini (Kalmbach *et al.*, 2018).

Dengan demikian, ukuran dendrit yang lebih besar membuat sel memiliki kelebihan dalam hal komputasi untuk mengintegrasikan informasi dalam jumlah besar secara lebih cepat dan efisien. Penelitian menunjukkan bahwa sel neuron manusia pada korteks temporal berukuran lebih besar dan cepat bila dibandingkan dengan spesies lainnya. Hal ini diduga memiliki pengaruh terhadap kecerdasan (Goriounova *et al.*, 2018), dan menunjukkan adanya fenomena pada skala seluler untuk memahami bagaimana kecerdasan terbentuk pada manusia. Pada kelompok individu dengan nilai IQ yang tinggi, sel piramidal pada sel kelompok tersebut menerima input sinaptik yang lebih banyak dan mampu mendapatkan integrasi sinaptik dengan resolusi yang lebih tinggi melalui suatu mekanisme dimana input sinaptik tersebut diproses secara independen dan simultan. Dikarenakan sel selalu dalam keadaan

kondisi menerima sejumlah besar sinyal dalam aktivitas yang berkaitan dengan kemampuan kognitif, sel neuron harus dapat menerima dan meneruskan berbagai input ini menjadi output. Neuron pada kelompok manusia dengan IQ yang tinggi mampu mengubah berbagai jenis input yang didapat pada neuron menjadi potensial aksi secara lebih efisien, sehingga mampu melakukan proses transfer informasi yang lebih banyak dan mempertahankan proses penembakan potensial aksi yang lebih cepat (*fast action potential firing*) bila dibandingkan dengan kelompok dengan IQ yang nilainya lebih rendah. Penemuan ini sejalan dengan studi genetik dan pencitraan otak, yaitu pada suatu penelitian ditemukan bahwa laju metabolisme pada sel neuron memiliki korelasi dengan kecerdasan (Haier et al., 1988; Savage et al., 2018).

Studi genetik pada kecerdasan juga menemukan adanya gen yang berperan dalam struktur dendrit dan kemampuan kognitif manusia. Pengelompokan atau *clustering* pada kandidat gen berdasarkan riset GWAS yang berkaitan dengan pencapaian pendidikan (*educational attainment*) dan difokuskan pada kelompok gen dengan fungsi biologis yang telah diketahui, menunjukkan adanya beberapa kelompok gen yang terlibat dalam morfologi korteks serebral, terutama pada organisasi dendrit dan *spine* dendritik (Okbay et al., 2016). Selain itu, studi lanjutan mengenai keterkaitan antara gen dengan kecerdasan yang telah dilakukan oleh Sniekers et al., 2017 dan Coleman et al., 2019, menunjukkan peran dari area intron pada gen FOXO3 dan promoternya yang mungkin dapat berperan dalam kecerdasan individu.

Gen FOXO3 merupakan bagian dari jalur pensinyalan insulin atau disebut dengan *insulin-like growth factor 1* (IGF-1) (Costales dan Kolevzon, 2016). Penelitian menunjukkan bahwa IGF-1 dapat meningkatkan pencabangan dan ukuran dendrit pada korteks somatosensori tikus, terutama sel piramidal pada lapisan korteks superfisial (Niblock et al., 2000). Kadar IGF-1 yang rendah juga menyebabkan fungsi kognitif yang buruk pada proses penuaan (Aleman et al., 1999; Tumati et al., 2016), serta berkaitan dengan

jumlah network atau jaringan fungsional terintegrasi yang lebih rendah pada area otak yang saling terkoneksi (Sorrentino et al., 2017). Dengan demikian, perbedaan setiap individu pada elaborasi sel piramidal dipengaruhi oleh kontrol genetik dan juga adaptasi fungsional pada sel tersebut. Hal ini menjadi salah satu adanya perbedaan kecerdasan pada manusia.

Bagaimanakah penemuan pada tingkat seluler dan genetik ini dapat ditranslasikan ke dalam penemuan riset skala makro seperti pada studi pencitraan otak? Banyak penelitian mengenai pencitraan otak yang menunjukkan bahwa ketebalan korteks dan volume otak memiliki hubungan dengan kecerdasan (Haier et al., 2004; Narr et al., 2007; Choi et al., 2008; Karama et al., 2009). Rekonstruksi pada kolom korteks pada resolusi skala nano menunjukkan bahwa volume korteks sebagian besar terdiri dari dendritik dan akson yang berperan dalam pemrosesan informasi. Dengan jumlah tujuh kali lebih banyak pada jumlah akson bila dibandingkan dengan dendrit (Kasthuri et al., 2015), hanya sebagian kecil dari proporsi volume ini yang terdiri dari sel tubuh neuron.

Dendrit dan axon merupakan struktur yang berperan dalam plastisitas sinaptik, penyimpanan informasi, dan dapat selalu bertumbuh dan berubah sepanjang hidup. Bahkan, pada perkembangan post-natal manusia menunjukkan bahwa dendrit akan selalu berkembang secara kontinu serta diiringi dengan bertambahnya volume korteks dan berkurangnya densitas neuron. Selain itu, area korteks frontal yang terbentuk seiring dengan usia dan pengalaman membutuhkan waktu yang lebih lama pada dinamika perubahan tersebut bila dibandingkan dengan area otak yang bertanggung jawab terhadap kemampuan visual, dimana area tersebut memiliki periode kritis pada awal perkembangan manusia (Huttenlocher, 1990). Seiring dengan perkembangan yang berkelanjutan tersebut, pohon dendritik pada lobus temporal manusia akan selalu tumbuh hingga usia tua. pohon dendritik individu berusia 80 tahun bersifat lebih ekstensif daripada di usia 50. Perbedaan tersebut dikarenakan meningkatnya jumlah dan rata-rata panjang

segmen terminal pada pohon dendritik tersebut. Hubungan antara ukuran dendritik dan kognisi juga ditambah dengan fakta bahwa pada pada pasien yang mengalami demensia atau pikun (*senile dementia*), pohon dendritik tidak bersifat ekstensif, dikarenakan sebagian besar segmen terminal pada dendritnya lebih sedikit dan pendek (Buell dan Coleman, 1979).

Selain itu, pada korteks manusia, terdapat gradien kompleksitas dendritik pada sepanjang area korteks. Area yang berkaitan dengan orde tinggi (*higher order association*) berperan dalam menyimpan dan memproses informasi yang lebih kompleks, memiliki neuron dengan ukuran dendrit yang lebih besar dan kompleks bila dibandingkan dengan area sensori primer. Selain itu, densitas sel tubuh neuron lebih rendah pada area asosiasi korteks (*cortical association areas*) bila dibandingkan dengan area sensori primer (Buell and Coleman, 1979; DeFelipe et al., 2002; Elston, 2003).

Panjangnya dendrit berkaitan dengan kecerdasan. Studi oleh Genc et al., 2018 menggunakan teknik pencitraan dengan kemampuan untuk menganalisis secara multi dimensi pada sel neuron melalui metode *multi-shell diffusion tensor* dapat mengestimasi kaitan antara densitas korteks parieto-frontal dengan kemampuan kognisi manusia. Studi tersebut menunjukkan bahwa nilai tes kognitif yang tinggi berasosiasi dengan rendahnya densitas neurit (Genc et al., 2018). Seiring dengan berkurangnya densitas neurit, maka bertambahlah panjang dendrit (Huttenlocher, 1990); sehingga hasil penelitian oleh Genc et al., 2018 dapat mengindikasikan bahwa area korteks parieto-frontal yang dimiliki oleh individu dengan kecerdasan tinggi memiliki neuron yang tidak terkumpul secara padat (*less densely packed*) dikarenakan neuron tersebut memiliki dendrit yang berukuran besar. hasil penelitian Genc et al., 2018 dan Gorionnova et al., 2018, mengindikasikan bahwa network atau sirkuit neuron yang berkaitan dengan kecerdasan tinggi (*higher intelligence*) bersifat tersusun secara jarang atau tidak terkumpul secara padat serta bersifat efisien. Sementara itu, neuron yang besar dan kompleks seperti neuron piramidal tersebar pada area korteks dan menempati banyak area pada korteks otak.

3 KESIMPULAN

Studi Pencitraan pada otak menunjukkan berbagai temuan penting pada bidang neurobiologi yang berkaitan dengan kecerdasan manusia, seperti dalam hal penemuan penting pada struktur dan fungsi anatomi otak yang berperan dalam kecerdasan: volume substansi abu (gray matter) dan ketebalannya, serta integritas dan fungsi substansi putih (white matter) pada korteks temporal, frontal, dan parietal. Namun, beberapa penelitian lanjutan menunjukkan bahwa pencitraan otak atau *neuroimaging* pada saat ini tidak dapat memberikan informasi yang cukup dalam skala resolusi temporal dan spasial untuk mempelajari substansi komputasional dari otak, yakni neuron dan kontak sinaptik.

Sementara itu, studi GWAS berfokus pada satu aspek yang sangat detail, yakni untuk mempelajari gen yang berperan dalam kecerdasan manusia. Progress besar telah didapat dengan cara meningkatkan ukuran sampel dan mengkombinasikan beberapa kohort. Hasil menunjukkan bahwa 98% dari varian genetik yang diduga berkaitan dengan kecerdasan tidak mengkode protein fungsional (**Gambar 2**), sehingga pada area genom intergenik dan intronik tersebut mungkin memiliki fungsi regulatori pada berbagai tahap pada proses perkembangan neuron. Namun demikian, sebagian kecil gen yang bisa menghasilkan protein fungsional tersebut memiliki pengaruh dalam berbagai fungsi neuron, seperti fungsi sinaptik dan plastisitas, interaksi sel dan metabolisme energi. Selain itu, semakin banyaknya database profil ekspresi gen menunjukkan bahwa ekspresi pada gen yang mengkode protein fungsional tersebut memiliki asosiasi atau hubungan dengan neuron utama yang ada pada korteks dan otak tengah, yakni neuron piramidal dan *spiny*.

Penelitian bidang neurosains dalam skala seluler, terutama yang menggunakan sampel potongan jaringan otak segar, memberikan perspektif baru bahwa adanya kemungkinan hubungan antara fungsi sel piramidal dan strukturnya terhadap kecerdasan manusia. Korelasi positif tersebut diantaranya adalah ukuran dendrit dan kecepatan

potensial aksi terhadap IQ individu. Namun demikian, masih terdapat beberapa pertanyaan yang masih harus dibuktikan dengan penelitian lebih lanjut.

Secara keseluruhan, tipe neuron apa saja yang memiliki peran dalam kecerdasan manusia? Perkembangan teknologi terbaru pada gene karakterisasi profil gene atau *gene profiling* dengan resolusi unit sel tunggal neuron menunjukkan bahwa terdapat sekitar 50 tipe transkriptomik sel piramidal pada tikus. Selain itu, pada area otak lainnya juga menunjukkan adanya tipe transkriptomik baru (Tasic et al., 2018). Dengan adanya teknologi transkriptomik tersebut, maka informasi yang terdapat pada data transkriptomik dapat memberikan informasi mengenai hubungan antara tipe sel dengan molekul target yang bersifat spesifik pada suatu area otak. Hal yang sama juga dapat ditemukan pada tipe neuron *striatal medium spiny*, dimana adanya hasil proyeksi map dapat memberikan informasi detail mengenai konektivitas yang tinggi pada seluruh area korteks serebral, serta dapat mengidentifikasi 29 domain berbeda pada otak tikus yang bersifat fungsional (Hintiryan et al., 2016). Dengan demikian, baik neuron piramidal dan *medium spiny* dapat membentuk populasi yang bersifat heterogen, dengan tipe sel berbeda yang memiliki berbagai fungsi serta memiliki pola konektivitas yang berbeda dengan berbagai lokasi lainnya di otak.

Berdasarkan hasil riset Tasic et al., 2018 dan Hintiryan et al., 2016, apakah fenomena neurobiologi yang ditemukan pada sel neuron tikus juga berkorelasi dengan sel neuron manusia? Bagaimana tipe sel yang berbeda tersebut dapat mendukung kecerdasan umum dan kemampuan kognitif yang spesifik pada manusia? Untuk menjawab hal tersebut diperlukan usaha dalam skala besar yg membutuhkan analisis komprehensif dengan jumlah data yang sangat besar, tidak hanya pada kohort manusia saja, namun hingga skala seluler dan juga tipe selnya. Hal ini memungkinkan untuk dilakukan di masa yang akan datang, dikarenakan adanya penelitian kolaborasi dalam skala global yang dilakukan oleh peneliti di berbagai negara (Brose, 2016).

DAFTAR PUSTAKA

- [1] Aleman, A., Verhaar, H. J., de Haan, E. H., de Vries, W. R., Samson, M. M., Drent, M. L., et al. (1999). Insulin-like growth factor-I and cognitive function in healthy older men. *J. Clin. Endocrinol. Metab.* 84, 471–475. doi: 10.1210/jc.84.2.471
- [2] Ardlie, K. G., Deluca, D. S., Segrè, A. V., Sullivan, T. J., Young, T. R., Gelfand, E. T., et al. (2015). Human genomics. the genotype-tissue expression (GTEx) pilot analysis: multitissue gene regulation in humans. *Science* 348, 648–660. doi: 10.1126/science.1262110
- [3] Beaulieu-Laroche, L., Toloza, E. H. S., van der Goes, M.-S., Lafourcade, M., Barnagian, D., Williams, Z. M., et al. (2018). Enhanced dendritic compartmentalization in human cortical neurons. *Cell* 175, 643.e14–651.e14. doi: 10.1016/j.cell.2018.08.045
- [4] Bekkers, J. M., and Häusser, M. (2007). Targeted dendrotomy reveals active and passive contributions of the dendritic tree to synaptic integration and neuronal output. *Proc. Natl. Acad. Sci. U S A* 104, 11447–11452. doi: 10.1073/pnas.0701586104
- [5] Buell, S. J., and Coleman, P. D. (1979). Dendritic growth in the aged human brain and failure of growth in senile dementia. *Science* 206, 854–856. doi: 10.1126/science.493989
- [6] Cajal, S. R. Y. (1893). Nueva concepta de la histologia de los centros nervosos. *Ann. Surg.* 18:122. doi: 10.1097/00000658-189307000-00018
- [7] Choi, Y. Y., Shamosh, N. A., Cho, S. H., DeYoung, C. G., Lee, M. J., Lee, J.-M., et al. (2008). Multiple bases of human intelligence revealed by cortical thickness and neural activation. *J. Neurosci.* 28, 10323–10329. doi: 10.1523/JNEUROSCI.3259-08.2008
- [8] Choi, Y. Y., Shamosh, N. A., Cho, S. H., DeYoung, C. G., Lee, M. J., Lee, J.-M., et al. (2008). Multiple bases of human intelligence revealed by cortical thickness and neural activation. *J. Neurosci.* 28, 10323–10329. doi: 10.1523/JNEUROSCI.3259-08.2008

- [9] Coleman, J. R. I., Bryois, J., Gaspar, H. A., Jansen, P. R., Savage, J. E., Skene, N., et al. (2019). Biological annotation of genetic loci associated with intelligence in a meta-analysis of 87,740 individuals. *Mol. Psychiatry* 24, 182–197. doi: 10.1038/s41380-018-0040-6
- [10] Costales, J., and Kolevzon, A. (2016). The therapeutic potential of insulin-like growth factor-1 in central nervous system disorders. *Neurosci. Biobehav. Rev.* 63, 207–222. doi: 10.1016/j.neubiorev.2016.01.001
- [11] Deary, I. J., Pattie, A., and Starr, J. M. (2013). The stability of intelligence from age 11 to age 90 years: the Lothian birth cohort of 1921. *Psychol. Sci.* 24, 2361–2368. doi: 10.1177/0956797613486487
- [12] Deary, I. J., Strand, S., Smith, P., and Fernandes, C. (2007). Intelligence and educational achievement. *Intelligence* 35, 13–21. doi: 10.1016/j.intell.2006.
- [13] DeFelipe, J., Alonso-Nanclares, L., and Arellano, J. I. (2002). Microstructure of the neocortex: comparative aspects. *J. Neurocytol.* 31, 299–316. doi: 10.1023/A:1024130211265
- [14] Deitcher, Y., Eyal, G., Kanari, L., Verhoog, M. B., Atenekeng Kahou, G. A., Mansvelder, H. D., et al. (2017). Comprehensive morpho-electrotonic analysis shows 2 distinct classes of L2 and L3 pyramidal neurons in human temporal cortex. *Cereb. Cortex* 27, 5398–5414. doi: 10.1093/cercor/bhx226
- [15] Drachman, D. A. (2005). Do we have brain to spare? *Neurology* 64, 2004–2005. doi: 10.1212/01.WNL.0000166914.38327.BB
- [16] Elston, G. N., and Fujita, I. (2014). Pyramidal cell development: postnatal spinogenesis, dendritic growth, axon growth, and electrophysiology. *Front. Neuroanat.* 8:78. doi: 10.3389/fnana.2014.00078
- [17] Eyal, G., Mansvelder, H. D., de Kock, C. P. J., and Segev, I. (2014). Dendrites impact the encoding capabilities of the axon. *J. Neurosci.* 34, 8063–8071. doi: 10.1523/JNEUROSCI.5431-13.2014

- [18] Eyal, G., Verhoog, M. B., Testa-Silva, G., Deitcher, Y., Lodder, J. C., Benavides-Piccione, R., et al. (2016). Unique membrane properties and enhanced signal processing in human neocortical neurons. *Elife* 5:e16553. doi: 10.7554/eLife.16553
- [19] Eyal, G., Verhoog, M. B., Testa-Silva, G., Deitcher, Y., Benavides-Piccione, R., DeFelipe, J., et al. (2018). Human cortical pyramidal neurons: from spines to spikes via models. *bioRxiv*: 267898 [Preprint]. doi: 10.1101/267898
- [20] Foverskov, E., Mortensen, E. L., Holm, A., Pedersen, J. L. M., Osler, M., and Lund, R. (2017). Socioeconomic position across the life course and cognitive ability later in life: the importance of considering early cognitive ability. *J. Aging Health* doi: 10.1177/0898264317742810 [Epub ahead of print].
- [21] Genç, E., Fraenz, C., Schlüter, C., Friedrich, P., Hossiep, R., Voelkle, M. C., et al. (2018). Diffusion markers of dendritic density and arborization in gray matter predict differences in intelligence. *Nat. Commun.* 9:1905. doi: 10.1038/s41467-018-04268-8
- [22] Goriounova, N. A., Heyer, D. B., Wilbers, R., Verhoog, M. B., Giugliano, M., Verbist, C., et al. (2018). Large and fast human pyramidal neurons associate with intelligence. *Elife* 7:e41714. doi: 10.7554/elife.41714
- [23] Gottfredson, L. S. (1997). Why g matters: the complexity of everyday life. *Intelligence* 24, 79–132. doi: 10.1016/s0160-2896(97)90014-3
- [24] Haier, R. J., Siegel, B. V. Jr., Nuechterlein, K. H., Hazlett, E., Wu, J. C., Paek, J., et al. (1988). Cortical glucose metabolic rate correlates of abstract reasoning and attention studied with positron emission tomography. *Intelligence* 12, 199–217. doi: 10.1016/0160-2896(88)90016-5
- [25] Herculano-Houzel, S. (2012). The remarkable, yet not extraordinary, human brain as a scaled-up primate brain and its associated cost. *Proc. Natl. Acad. Sci. U S A* 109, 10661–10668. doi: 10.1073/pnas.1201895109

- [26] Hulshoff Pol, H. E., Schnack, H. G., Posthuma, D., Mandl, R. C. W., Baaré, W. F., van Oel, C., et al. (2006). Genetic contributions to human brain morphology and intelligence. *J. Neurosci.* 26, 10235–10242. doi: 10.1523/JNEUROSCI.1312-06.2006
- [27] Huttenlocher, P. R. (1990). Morphometric study of human cerebral cortex development. *Neuropsychologia* 28, 517–527. doi: 10.1016/0028-3932(90)90031-i
- [28] Jacobs, B., Schall, M., Prather, M., Kapler, E., Driscoll, L., Baca, S., et al. (2001). Regional dendritic and spine variation in human cerebral cortex: a quantitative golgi study. *Cereb. Cortex* 11, 558–571. doi: 10.1093/cercor/11.6.558
- [29] Kalmbach, B. E., Buchin, A., Long, B., Close, J., Nandi, A., Miller, J. A., et al. (2018). h-channels contribute to divergent intrinsic membrane properties of supragranular pyramidal neurons in human versus mouse cerebral cortex. *Neuron* 100, 1194.e5–1208.e5. doi: 10.1016/j.neuron.2018.10.012
- [30] Karama, S., Ad-Dab'bagh, Y., Haier, R. J., Deary, I. J., Lyttelton, O. C., Lepage, C., et al. (2009). Positive association between cognitive ability and cortical thickness in a representative US sample of healthy 6 to 18 year-olds. *Intelligence* 37, 145–155. doi: 10.1016/s1053-8119(09)70678-0
- [31] Kasthuri, N., Hayworth, K. J., Berger, D. R., Schalek, R. L., Conchello, J. A., Knowles-Barley, S., et al. (2015). Saturated reconstruction of a volume of neocortex. *Cell* 162, 648–661. doi: 10.1016/j.cell.2015.06.054
- [32] Kramvis, I., Mansvelder, H. D., and Meredith, R. M. (2018). Neuronal life after death: electrophysiologic recordings from neurons in adult human brain tissue obtained through surgical resection or postmortem. *Handb. Clin. Neurol.* 150, 319–333. doi: 10.1016/b978-0-444-63639-3.00022-0
- [33] Lam, M., Trampush, J. W., Yu, J., Knowles, E., Davies, G., Liewald, D. C., et al. (2017). Large-scale cognitive GWAS meta-analysis reveals tissue-specific neural expression and potential nootropic drug targets. *Cell Rep.* 21, 2597–2613. doi: 10.1016/j.celrep.2017.11.028

- [34] Manger, P. R., Spocter, M. A., and Patzke, N. (2013). The evolutions of large brain size in mammals: the 'over-700-gram club quartet'. *Brain Behav. Evol.* 82, 68–78. doi: 10.1159/000352056
- [35] Mohan, H., Verhoog, M. B., Doreswamy, K. K., Eyal, G., Aardse, R., Lodder, B. N., et al. (2015). Dendritic and axonal architecture of individual pyramidal neurons across layers of adult human neocortex. *Cereb. Cortex* 25, 4839–4853. doi: 10.1093/cercor/bhv188
- [36] Mortensen, H. S., Pakkenberg, B., Dam, M., Dietz, R., Sonne, C., Mikkelsen, B., et al. (2014). Quantitative relationships in delphinid neocortex. *Front. Neuroanat.* 8:132. doi: 10.3389/fnana.2014.00132
- [37] Narr, K. L., Woods, R. P., Thompson, P. M., Szeszko, P., Robinson, D., Dimtcheva, T., et al. (2007). Relationships between IQ and regional cortical gray matter thickness in healthy adults. *Cereb. Cortex* 17, 2163–2171. doi: 10.1093/cercor/bhl125
- [38] Niblock, M. M., Brunso-Bechtold, J. K., and Riddle, D. R. (2000). Insulin-like growth factor I stimulates dendritic growth in primary somatosensory cortex. *J. Neurosci.* 20, 4165–4176. doi: 10.1523/JNEUROSCI.20-11-04165.2000
- [39] Okbay, A., Beauchamp, J. P., Fontana, M. A., Lee, J. J., Pers, T. H., Rietveld, C. A., et al. (2016). Genome-wide association study identifies 74 loci associated with educational attainment. *Nature* 533, 539–542. doi: 10.1038/nature 17671
- [40] Pakkenberg, B., and Gundersen, H. J. (1997). Neocortical neuron number in humans: effect of sex and age. *J. Comp. Neurol.* 384, 312–320. doi: 10.1002/(sici)1096-9861(19970728)384:2<312::aid-cne10>3.3.co;2-g
- [41] Plomin, R., and Deary, I. J. (2015). Genetics and intelligence differences: five special findings. *Mol. Psychiatry* 20, 98–108. doi: 10.1038/mp. 2014.105

- [42] Posthuma, D., de Geus, E. J., and Boomsma, D. I. (2001). Perceptual speed and IQ are associated through common genetic factors. *Behav. Genet.* 31, 593–602. doi: 10.1023/A:1013349512683
- [43] Salinas, E., and Sejnowski, T. J. (2001). Correlated neuronal activity and the flow of neural information. *Nat. Rev. Neurosci.* 2, 539–550. doi: 10.1038/350 86012
- [44] Savage, J. E., Jansen, P. R., Stringer, S., Watanabe, K., Bryois, J., de Leeuw, C. A., et al. (2018). Genome-wide association meta-analysis in 269,867 individuals identifies new genetic and functional links to intelligence. *Nat. Genet.* 50, 912–919. doi: 10.1038/s41588-018-0152-6
- [45] Scholtens, L. H., Schmidt, R., de Reus, M. A., and van den Heuvel, M. P. (2014). Linking macroscale graph analytical organization to microscale neuroarchitectonics in the macaque connectome. *J. Neurosci.* 34, 12192–12205. doi: 10.1523/JNEUROSCI.0752-14.2014
- [46] Smith, S. L., Smith, I. T., Branco, T., and Häusser, M. (2013). Dendritic spikes enhance stimulus selectivity in cortical neurons *in vivo*. *Nature* 503, 115–120. doi: 10.1038/nature12600
- [47] Sniekers, S., Stringer, S., Watanabe, K., Jansen, P. R., Coleman, J. R. I., Krapohl, E., et al. (2017). Genome-wide association meta-analysis of 78,308 individuals identifies new loci and genes influencing human intelligence. *Nat. Genet.* 11:201. doi: 10.1038/ng.3869
- [48] Sorrentino, P., Nieboer, D., Twisk, J. W. R., Stam, C. J., Douw, L., and Hillebrand, A. (2017). The hierarchy of brain networks is related to insulin growth factor-1 in a large, middle-aged, healthy cohort: an exploratory magnetoencephalography study. *Brain Connect* 7, 321–330. doi: 10.1089/brain.2016.0469
- [49] Spearman, C. (1904). “General intelligence,” objectively determined and measured. *Am. J. Psychol.* 15, 201–292. doi: 10.2307/1412107

- [50] Tasic, B., Yao, Z., Graybiel, L. T., Smith, K. A., Nguyen, T. N., Bertagnoli, D., et al. (2018). Shared and distinct transcriptomic cell types across neocortical areas. *Nature* 563, 72–78. doi: 10.1038/s41586-018-0654-5
- [51] Testa-Silva, G., Verhoog, M. B., Linaro, D., de Kock, C. P. J., Baayen, J. C., Meredith, R. M., et al. (2014). High bandwidth synaptic communication and frequency tracking in human neocortex. *PLoS Biol.* 12:e1002007. doi: 10.1371/journal.pbio.1002007
- [52] Trampush, J. W., Yang, M. L. Z., Yu, J., Knowles, E., Davies, G., Liewald, D. C., et al. (2017). GWAS meta-analysis reveals novel loci and genetic correlates for general cognitive function: a report from the COGENT consortium. *Mol. Psychiatry* 22, 336–345. doi: 10.1038/mp.2016.244
- [53] Tumati, S., Burger, H., Martens, S., van der Schouw, Y. T., and Aleman, A. (2016). Association between cognition and serum insulin-like growth factor-1 in middle-aged and older men: an 8 year follow-up study. *PLoS One* 11:e0154450. doi: 10.1371/journal.pone.0154450
- [54] van den Heuvel, M. P., Scholtens, L. H., Feldman Barrett, L., Hilgetag, C. C., and de Reus, M. A. (2015). Bridging cytoarchitectonics and connectomics in human cerebral cortex. *J. Neurosci.* 35, 13943–13948. doi: 10.1523/JNEUROSCI.2630-15.2015
- [55] Vasile, F., Dossi, E., and Rouach, N. (2017). Human astrocytes: structure and functions in the healthy brain. *Brain Struct. Funct.* 222, 2017–2029. doi: 10.1007/s00429-017-1383-5
- [56] Verhoog, M. B., Obermayer, J., Kortleven, C. A., Wilbers, R., Wester, J., Baayen, J. C., et al. (2016). Layer-specific cholinergic control of human and mouse cortical synaptic plasticity. *Nat. Commun.* 7:12826. doi: 10.1038/ncomms12826

- [57] Vetter, P., Roth, A., and Häusser, M. (2001). Propagation of action potentials in dendrites depends on dendritic morphology. *J. Neurophysiol.* 85, 926–937. doi: 10.1152/jn.2001.85.2.926
- [58] Volkow, N. D., Wise, R. A., and Baler, R. (2017). The dopamine motive system: implications for drug and food addiction. *Nat. Rev. Neurosci.* 18, 741–752. doi: 10.1038/nrn.2017.130

**ECTOPARASITE DIVERSITY AND ABUNDANCE
IN VANNAMEI SHRIMP (*LITOPENAEUS VANNAMEI*)
CATCHING OF FROM ESTUARIAN CILACAP
CHILDREN AS EARLY CONSERVATION EFFORT**

**KERAGAMAN DAN KELIMPAHAN EKTOPARASIT
PADA UDANG VANNAMEI (*LITOPENAEUS
VANNAMEI*) HASIL TANGKAPAN ESTUARIA
SEGARA ANAKAN CILACAP SEBAGAI UPAYA
KONSERVASI DINI**

Rokhmani¹, Kusbiyanto², Yosep Ditya Nugroho³

*Biologi of faculty, Universitas Jenderal Soedirman. Jl. Dr. Suparno
63, Purwokerto, Banyumas 53122, Central Java. (INDONESIA)
rokhmanitatiek@gmail.com*

Abstract

Segara Anakan Cilacap has a wealth of vannamei shrimp species which have high economic value. Ectoparasite attacks can occur and can cause a decrease in the vannamei shrimp population in the waters. This study was conducted to determine the diversity and abundance of ectoparasites in vannamei shrimp (*Litopenaeus vannamei*) caught in the Segara Anakan Cilacap estuary. The research method used was a survey method with a random sampling technique. Vannamei shrimp samples were taken 3 times with an interval of 1 week. The total sample of vannamei shrimp taken from 3 sampling times was 90 individuals. The research variables are diversity and abundance. Parameters are the number of infected shrimp; and the types of ectoparasites that attack vannamei shrimp. The results showed that the types of ectoparasites found were *Oodinium* sp, *Vorticella* sp, and *Zoothanium* sp. the prevalence of ectoparasites obtained was 33%. The diversity of ectoparasites did not vary, while the abundance was 0.57 individuals

Keywords: Cilacap, Ectoparasites, Diversity, Abundance; *Litopenaeus vannamei*

Abstrak

Segara Anakan Cilacap memiliki kekayaan spesies udang vannamei yang memiliki nilai ekonomis yang tinggi. Serangan ektoparasit dapat terjadi dan dapat menyebabkan menurunnya populasi udang vannamei di suatu perairan. Telah dilakukan penelitian ini bertujuan untuk mengetahui keragaman dan kelimpahan ektoparasit pada udang vannamei (*Litopenaeus vannamei*) hasil tangkapan estuaria Segara Anakan Cilacap Metode penelitian yang digunakan adalah metode survei teknik *random sampling*. Sampel udang vannamei yang diambil sebanyak 3 kali dengan interval waktu 1 minggu. Sampel udang vannamei yang diambil total sampel dari 3 kali sampling adalah 90 ekor. Variabel penelitian berupa keragaman dan kelimpahan. Parameter adalah berapa jumlah udang yang terinfeksi; serta jenis jenis ektoparasit yang menyerang udang vannamei. Hasil penelitian bahwa jenis ektoparasit yang ditemukan yaitu *Oodinium sp*, *Vorticella sp*, dan *Zoothanium sp*. prevalensi ektoparasit yang didapat yaitu 33%. Keragaman ektoparasit tidak beragam, sedangkan kelimpahannya adalah 0,57ekor/individ.

Kata kunci: Cilacap, Ektoparasit, Keragaman, Kelimpahan; *Litopenaeus vannamei*

1 PENDAHULUAN

Udang Vannamei (*Litopenaeus vannamei*) merupakan jenis udang putih yang dibudidayakan di Indonesia yang berasal dari perairan Amerika Tengah. Jenis udang yang dikenal dengan pasific white shrimp sudah lama dibudidayakan di negara-negara Amerika Tengah dan Selatan seperti Ekuador, Venezuela, Panama, Brazil dan Meksiko (Rusmiyati, 2011). Udang Vannamei (*L. vannamei*) merupakan spesies udang putih yang dibudidayakan di Indonesia yang berasal dari perairan Amerika Tengah atau disebut pasific white shrimp. Udang Vannamei diperkenalkan pada masyarakat pembudidaya secara resmi pada tahun 2001 setelah menurunnya produksi udang windu (*Penaeus monodon*) karena dalam proses produksi terdapat berbagai masalah yang dihadapi, baik masalah

teknis maupun non teknis (Subyakto *et al.*, 2009). Spesies ini relatif mudah untuk berkembang biak dan dibudidayakan, dengan tantangan adanya serangan penyakit, salah satunya adalah parasit. Udag vannamei masuk ke perairan umum melalui berbagai cara, misalnya lepasnya udang dari tambak budidaya nelayan di pesisir, ada juga penyebab lainnya yaitu proses pelepasan bibit udang vannamei di perairan umum.

Parasit adalah organisme yang melakukan invasi untuk mendapatkan makanan, tempat tinggal, perlindungan dan kesempatan untuk berkembangbiak dalam tubuh inangnya (Prasadi, 2015). Parasit merupakan salah satu permasalahan yang sering muncul dalam ekologi perairan, baik di perairan laut maupun tawar (Rohde, 1982). Parasit berdasarkan tempat hidupnya, dibedakan menjadi ektoparasit dan endoparasit. Ektoparasit adalah parasit yang hidup pada permukaan luar tubuh inang, sedangkan endoparasit adalah parasit yang hidup pada organ bagian dalam inangnya. Protozoa, cacing (Trematoda, Cestoda dan Nematoda) dan Crustaceae (Branchiura, Copepoda, Isopoda) adalah golongan parasit yang sering ditemukan pada organisme laut seperti ikan, kepiting dan udang. (Anshary, 2008).

Perairan laut Kabupaten Cilacap merupakan jalur pelayaran untuk industri semen dan industri pengolahan minyak bumi serta banyak dimanfaatkan untuk berbagai aktivitas seperti adanya aktivitas di bengkel kapal, pelabuhan, pemukiman dan pertanian. Keberadaan aktivitas tersebut menimbulkan masuknya bahan pencemar yang beracun dan berbahaya ke dalam perairan sehingga mengakibatkan penurunan kualitas perairan (Hidayati *et al.*, 2014). Hubungan inang dengan ektoparasit di pengaruhi oleh kondisi lingkungan seperti suhu, letak geografis, kedalaman air serta gangguan atropogenik lain (Sheath *et al.*, 2016).

Prevalensi adalah persentase udang yang terinfeksi parasit dibandingkan dengan seluruh sampel udang yang diperiksa (Awilia, 2002). Jenis ektoparasit yang menginfeksi udang vannamei (*L. vannamei*) yang dibudidayakan di pertambakan Kabupaten Aceh

Besar terdiri dari spesies *Zoothamnium* sp., *Vorticella* sp. dan *Epistylis* sp. Ektoparasit *Vorticella* sp. memiliki nilai intensitas dan prevalensi yang tinggi dibandingkan ektoparasit lainnya dengan nilai intensitas 34 individu/ekor dan prevalensi sebesar 67% (Nurlaila *et al.*, 2016).

Berdasarkan latar belakang yang telah disampaikan, maka dapat dirumuskan masalah sebagai berikut:

1. Bagaimana Keragaman ektoparasit pada udang vannamei (*L. vannamei*) hasil tangkapan Estuaria Segara Anakan Kabupaten Cilacap.
2. Bagaimana Kelimpahan ektoparasit pada udang vannamei (*L. vannamei*) hasil tangkapan Estuaria Segara Anakan Kabupaten Cilacap.

Berdasarkan rumusan masalah diatas, maka tujuan dari penelitian ini, yaitu:

1. Mengetahui Keragaman ektoparasit pada udang vannamei (*L. vannamei*) hasil tangkapan Estuaria Segara Anakan Kabupaten Cilacap.
2. Mengetahui Kelimpahan ektoparasit pada udang vannamei (*L. vannamei*) hasil tangkapan Estuaria Segara Anakan Kabupaten Cilacap.

Hasil penelitian ini diharapkan dapat memberikan informasi ilmiah mengenai prevalensi dan jenis ektoparasit udang vannamei (*L. vannamei*) yang terdapat di perairan laut Cilacap yang digunakan sebagai sumber data supaya dapat diambil langkah strategis dalam pengendalian kondisi lingkungan dan dapat diambil dan langkah-langkah antisipatif pencegahan serta pengendaliannya jika terbukti positif terinfeksi ektoparasit.

2 METODE PENELITIAN

A. Materi, Waktu, Lokasi Penelitian

1. Materi Penelitian

Materi penelitian terdiri atas bahan dan alat yang digunakan dalam penelitian. Bahan-bahan yang digunakan dalam penelitian ini adalah, udang vannamei (*L. vannamei*) hasil tangkapan Estuaria Segara Anakan Kabupaten Cilacap. Alat-alat yang digunakan dalam penelitian ini adalah, styrofoam berukuran 25x20x30 cm, ember plastik, gunting bedah, pinset, baskom, tissue, mikroskop, object glass, glove, masker dan pipet tetes. Bahan-bahan yang digunakan meliputi udang vannamei (*Litopenaeus vannamei*), es batu dan akuades.

2. Lokasi dan Waktu Penelitian

Penelitian dilakukan di Segara Anakan, Kabupaten Cilacap, Provinsi Jawa Tengah pada dengan beberapa stasiun pilihan (Gambar 2. Tabel 1). Pengamatan mikroskopis dilakukan di Laboratorium Parasitologi dan Entomologi Fakultas Biologi Universitas Jenderal Soedirman.



Gambar 2.2. Skema Lokasi Pengambilan Sampel di Estuaria Segara Anakan Cilacap. Sumber: Nordhaus, 2009.

Tabel 3.1. Koordinat Stasiun Penelitian

No.	Stasiun	Koordinat
1	Desa Kutawaru	07°40'35,48" LS 108°52'03,32" BT
2	Desa Sembir	07°39'25,04" LS 108°50'58,06" BT
3	Desa Alasmalang	07°40'19,57" LS 108°49'18,62" BT

B. Metode Penelitian

1. Rancangan Percobaan

Penelitian ini dilakukan menggunakan metode survei, dengan teknik *random sampling*. Sampel udang vannamei (*L. vannamei*) diambil langsung di Segara Anakan dan diambil langsung dari nelayan. Metode yang dilakukan yaitu acak, Pengambilan Sampel diambil sebanyak 3 kali dengan interval waktu 1 minggu. Sampel udang vannamei yang diambil total sebanyak 90 ekor.

2. Variabel dan Parameter Penelitian

Variabel yang diamati dalam penelitian ini meliputi variabel prevalensi parasit dengan parameter jumlah ektoparasit yang ditemukan pada udang yang terinfeksi. Variabel keragaman ektoparasit dengan parameter jumlah individu dan jenis ektoparasit.

3. Cara Kerja Pengambilan Sampel

a. Cara Pengambilan Sampel

- 1) Menyiapkan Kotak styrofoam berukuran 25x20x30 cm beserta tutupnya.
- 2) Udang vannamei yang baru saja didaratkan dari kapal segera diambil kemudian dimasukkan ke kotak Styrofoam yang berisi es batu.
- 3) Kotak Styrofoam yang berisi udang vannamei ditutup dengan menggunakan tutup Styrofoam kemudian udang vannamei dibawa ke Laboratorium Entomologi dan Parasitologi Fakultas Biologi Universitas Jenderal Soedirman untuk dilakukan pemeriksaan ektoparasit.

b. Metode Pemeriksaan Parasit

- 1) Udang vannamei yang telah dibawa menggunakan styrofoam di pindahkan ke baskom.
- 2) Permukaan tubuh udang vannamei kemudian diamati secara visual untuk dilihat pemeriksaan awal dari serangan ektoparasit.
- 3) Bagian tubuh udang seperti antenna, karapak, periopod, pleopod, uropod, dan kulit abdomen dipotong menggunakan gunting bedah.
- 4) Bagian-bagian tubuh udang yang telah dipotong diletakkan pada object glass kemudian ditetesi dengan larutan akuades.

- 5) Preparat diamati menggunakan mikroskop dengan perbesaran 4x10
- 6) Jumlah ektoparasit yang menginfeksi udang vannamei dihitung pada bagian antenna, karapak, peripod, pleopod, uropod, dan kulit abdomen.

4. Analisis Data

Parasit yang ditemukan dicatat jenis, jumlah dan organ tempat parasit tersebut ditemukan serta dihitung nilai prevalensi menggunakan rumus (Dogiel *et al.*, 1970). Selanjutnya, dianalisa secara deskriptif.

$$\text{Prevalensi (\%)} = \frac{\sum \text{Jumlah udang yang terserang parasit}}{\sum \text{udang yang diperiksa}} \times 100$$

Kelimpahan adalah jumlah total ektoparasit yang ditemukan di bagi jumlah total sampel udang.

3 HASIL

Hasil penelitian menunjukkan bahwa pravelensi ektoparasit yang menginfeksi udang memiliki nilai sebesar 33.3%. Berdasarkan jumlah sampel yang digunakan sebanyak 90 sampel udang dan 30 diantaranya terinfeksi ektoparasit. Berdasarkan tabel 3.1, kriteria pravelensi infeksi parasit (Williams & Williams, 1996) hasil masuk kedalam kategori umum. Intensitas serangan ektoparasit dapat dipengaruhi oleh gerakan udang yang sering bergerak di dasar perairan dengan substrat lumpur. Parasit yang terdapat di dasar perairan dapat dengan mudah menempel pada bagian organ kaki dan menyebar dengan cepat hingga intensitas meningkat (Novita *et al.*, 2016).

Berdasarkan penelitian prevalensi dan jenis ektoparasit pada udang vannamei hasil tangkapan estuaria sagara anakan cilacap, didapatkan tingkat pravelensi sebesar 33,3%. Angka ini dapat dikatakan lebih kecil dibandingkan dengan penelitian-penelitian sebelumnya dengan lokasi sampling yang berbeda. Seperti pada penelitian Mahasri *et al.* (2018), yang meneliti tentang pravelensi

ektoparasit udang vannamei ditempat penggelondongan di Gresik dengan padat tebar yang berbeda. Hasil yang didapatkan nilai sebesar 56,66% pada padat tebar 3 ekor/liter, 63,33% pada padat tebar 6 ekor/liter, 73,33 pada padat tebar 7 ekor/liter, 93,33 pada padat tebar 9 ekor/liter, dan 100% pada padat tebar 11 ekor/liter. Hal yang tidak jauh berbeda ditemukan pada penelitian Nurlaila et al. (2016) tentang identifikasi dan prevalensi ektoparasit udang vannamei di kabupaten Aceh Besar yang menghasilkan nilai berkisar antara 33,3% sampai dengan 56%. Perbedaan angka prevalensi tersebut dapat disebabkan oleh beberapa faktor.

Menurut Nurlaila et al.(2016) tingginya prevalensi perkebangan ektoparasit dapat disebabkan oleh faktor-faktor lingkungan udang sangat mendukung pertumbuhan ektoparasit. Hal lain yang berpengaruh adalah suhu lingkungan, karena menurut Irvansyah et al. (2012), suhu lingkungan yang optimum untuk perkembangan protozoa seperti *Zoothamnium* sp. adalah diatas 30°C. Faktor yang cukup berpengaruh pada tingginya prevalensi adalah padat tebar dari udang, hal tersebut dikemukakan oleh Mahasri et al. (2018), bahwa terdapat hubungan yang sangat erat antara padat tebar dengan prevalensi ektoparasit, dimana semakin tinggi padat tebar akan semakin tinggi juga nilai prevalensi ektoparasit. Hasil yang didapatkan pada penelitian yang dilaksanakan cenderung tidak terlalu besar dapat disebabkan karena telah kondisi lingkungan di estuaria sagara anakan tidak optimum untuk perkembangan ektoparasit.

A. Jenis Ektoparasit

Jenis ektoparasit yang ditemukan pada sampel udang vannamei (*L. vannamei*) di Segara Anakan terdiri dari 4 spesies yaitu *Oodinium* sp. *Apisoma* sp. *Vorticella* sp. dan, *Zoothanium* sp. (Tabel 4.1).

Tabel 3.1. Jenis dan Jumlah Ektoparasit

NO	ORGAN	EKTOPARASIT YANG DITEMUKAN	JUMLAH
1.	Carapaks	<i>Zoothanium</i> sp.	16
		<i>Vorticella</i> sp.	1
2.	Badan	<i>Oodinium</i> sp	31
3.	Kaki (pleopods)	<i>Apisoma</i> sp.	3
	TOTAL		51

Berdasarkan tabel 3.1, ektoparasit yang paling banyak ditemukan adalah *Oodinium* sp., ektoparasit ini hanya ditemukan pada bagian badan sebanyak 31 buah. *Zoothanium* sp., ditemukan pada organ bagian karapaks dengan total 16 buah. *Apisoma* sp., ditemukan pada organ bagian kaki (pleopods) sebanyak 3 buah. Spesies *Vorticella* sp. ditemukan dalam jumlah yang relatif sedikit yaitu ditemukan 1 buah pada spesies *Zoothanium* sp. Menurut Sarjito et al. (2013), Timbulnya penyakit parasit pada udang merupakan proses dinamis dan interaksi yang kompleks antara tiga komponen dalam ekosistem yaitu inang yang lemah akibat berbagai *stressor*, patogen yang virulen dan kualitas lingkungan yang kurang optimal.

1. *Oodinium* sp

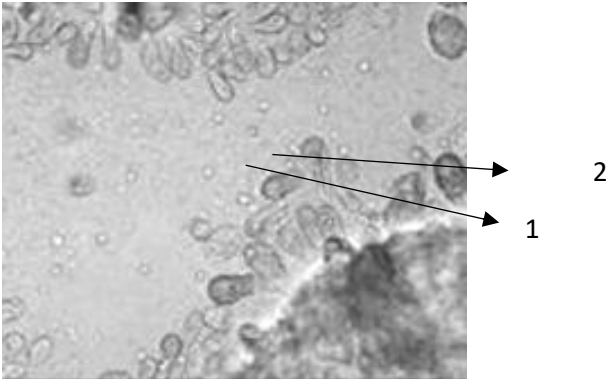

Gambar 4.1 Morfologi parasit *Oodinium* sp. yang menginfeksi udang *Vannamei* (1) Pedicle (2) Zooid (Perbesaran 40x)

Oodinium sp. ditemukan sebanyak 31 buah pada bagian badan. *Oodinium* sp. yang diamati memiliki bentuk oval terdapat pula yang berbentuk fusiform serta memiliki juluran sitoplasma. Hal tersebut sesuai dengan pernyataan Salam & Hidayati (2017), *Oodinium* sp. mempunyai bentuk oval dengan panjang 101.5 μ m. Ditemukan dalam 2 fase yaitu fase tropont yang ditandai dengan adanya juluran sitoplasma, dan fase mitosis yang ditandai dengan adanya segmentasi sel. Menurut Kabata (1985), Infeksi *Oodinium* sp. disebabkan karena penetrasi akan rizoid ke sel epitel inang, sehingga menyebabkan nekrosis, pendarahan dan mengalami infeksi sekunder oleh bakteri dan jamur.

2. *Apiosoma* sp.

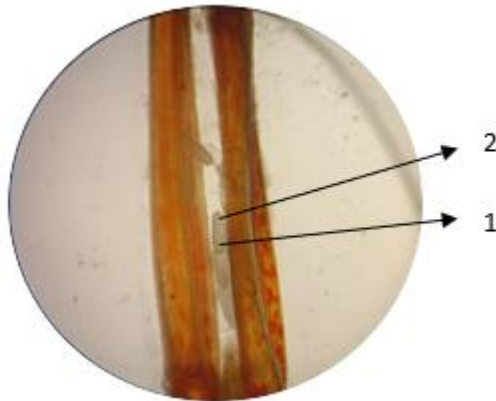

Gambar 4.2 Morfologi parasite *Apiosoma* sp. Yang menginfeksi udang vannamei (1) Pedicle (2) Zooid (Perbesaran 40x)

Apiosoma sp. Ditemukan sebanyak 3 buah pada bagian kaki pleopods. *Apiosoma* sp. memiliki bentuk sel oval, terdapat silia pada bagian posterior dan hidup berkoloni antara 2-5 individu. Hal tersebut sesuai dengan pernyataan Nurhalimah (2017), bahwa *Apiosoma* sp. memiliki ciri-ciri berbentuk silinder memanjang seperti buah pir, juga memiliki makronukleus berbentuk kerucut atau bulat. Menurut Li et al. (2008), dengan ditemukannya *Apiosoma* sp. dapat mempengaruhi ikan menjadi pergerakan lambat, kehilangan keseimbangan dan sering muncul ke permukaan air. Parasit ini dapat melepaskan diri dari kelompok dan mencari inang baru dengan cara berenang bebas. Parasit ini umumnya dikategorikan dalam parasit ikan, namun parasit ini menemukan inang baru atau tertempel pada inang yang berupa udang vannamei (*Litopenaeus vannamei*).

3. *Vorticella* sp.

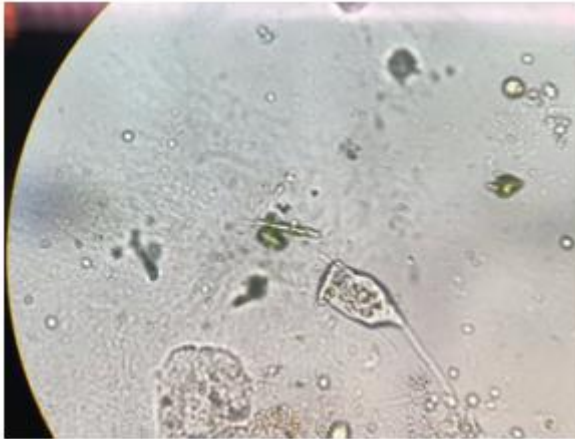

Gambar 4.3 Morfologi parasit *Vorticella* sp. yang menginfeksi udang *Vannamei* (1) Pedicle (2) Zooid (Perbesaran 40x)

Vorticella sp. merupakan spesies yang sangat sedikit ditemukan pada penelitian ini. Berdasarkan tabel 4.1, *Vorticella* sp. sering menginfeksi bagian badan. Berdasarkan gambar 4.2. terlihat bahwa bentuk *Vorticella* sp. agak lonjong dan soliter, serta mempunyai bagian *pedicle* dan *zooid*. Menurut Nurlaila et al. (2016), ciri-ciri dari *Vorticella* sp. adalah memiliki tangkai yang bersifat kontraktile, soliter yang berwarna kekuningan. Hal yang hampir serupa dikemukakan oleh Setyaningsih et al. (2014) menyatakan bahwa bentuk badan dari *Vorticella* sp. adalah lonceng, mempunyai tangkai yang tidak bercabang, dan hidup secara soliter.

4. *Zoothanium* sp.

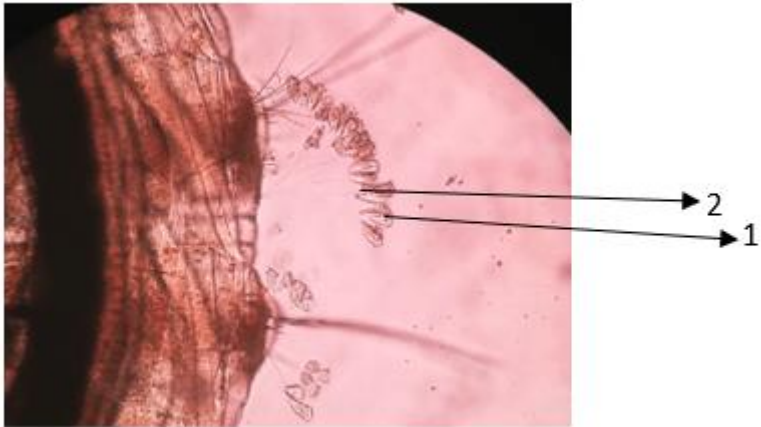

Gambar 4.4 Morfologi parasit *Zoothanium* sp. yang menginfeksi udang *Vannamei* (1) Pedicle (2) Zooid (Perbesaran 40x)

Zoothanium sp. ditemukan dalam jumlah yang relatif sedikit yang terdapat pada bagian karapak udang. *Zoothanium* sp. yang diamati pada gambar 4.4 memiliki bentuk tubuh kerucut agak membulat, hidup dalam koloni dan menempel pada substratnya dengan menggunakan tangkai yang bercabang. Hal ini sesuai dengan pernyataan Irvansyah et al. (2012), yang menyatakan bahwa *Zoothanium* sp. mempunyai morfologi berkoloni, berwarna keputihan, serta menempel pada inangnya dengan myoneme bercabang 2. Spesies ini juga mempunyai bentuk globuler yang terdiri dari tangkai peristomial yang bersilia. Menurut Mahasri et al. (2008), *Zoothanium* sp. merupakan ciliata yang hidup normal pada perairan berkualitas rendah sehingga meskipun kualitas perairan baik, parasit ini tetap bisa tumbuh.

4 KESIMPULAN DAN SARAN

A. Kesimpulan

Berdasarkan hasil dan pembahasan maka dapat disimpulkan bahwa: Jenis ektoparasit yang ditemukan pada sampel udang vannamei (*L. vannamei*) hasil tangkapan di Segara Anakan terdiri dari 4 spesies yaitu *Oodinium* sp. *Apisoma* sp. *Vorticella* sp. dan *Zoothanium* sp. prevalensi ektoparasit yang didapat yaitu 33%. Keragaman ektoparasit tidak beragam, sedangkan kelimpahannya adalah 0,57ekor/individ.

B. Saran

Berdasarkan penelitian ini didapatkan informasi bahwa udang yang berkembang di alam dapat terjangkit ektoparasit yang menyebabkan pertumbuhan udang vannamei (*L.vannamei*) dapat terganggu. Saran untuk penelitian berikutnya supaya lebih mengkaji lebih dalam tentang ektoparasit udang dalam pantai yang berbeda dan jenis yang berbeda agar mendapatkan perbandingan.

DAFTAR PUSTAKA

- [1] Anshary, H. 2008. Pembelajaran Parasitologi Ikan. Makassar: Universitas Hassanudin
- [2] Awilia, V. 2002. Inventarisasi dan Distribusi Parasit pada Ikan Maanvis (*Pterophyllumscalare*) dan Ikan Black Ghost (*Apteronotus albifrons*) di DKI Jakarta. Doctoral dissertation. Bogor: IPB.
- [3] Buwono, I. D. 1993. Tambak Udang Windu Sistem Pengelolaan Berpola Intensif. Kanisius. Yogyakarta. hal. 93-94.
- [4] Dogiel, V.A.G., G.K. Petrushevski., I. Polyanski. 1970. Parasitology of fishes. T.F.H. Publiser, Hongkong.
- [5] Ghufuran, M.H dan Kordi K. 2012. Jurus Jitu Pengelolaan Tambak Budi Daya Perikanan Ekonomis. Lily Publisher. Yogyakarta. hal. 33-34.

- [6] Hidayati, N.V., Siregar, A.S., Sari, L.K. & Putra, G.L., Hartono, I P., Nugraha & Agung, D.S. 2014. Pendugaan Tingkat Kontaminasi Logam Berat Pb, Cd dan Cr pada Air dan Sedimen di Perairan Segara Anakan, Cilacap. *Omni-Akuatika*, 10(1), pp. 30-39.
- [7] Irvansyah, M.Y., Abdulgani, N. & Mahasri, G. 2012. Identifikasi dan Intensitas Ektoparasit pada Kepiting Bakau (*Scylla serrata*) Stadia Kepiting Muda di Pertambakan Kepiting, Kecamatan Sedati, Kabupaten Sidoarjo, *Jurnal Sains dan Seni ITS*, 1(1), pp. 1-5.
- [8] Kabata, Z. 1985. *Parasites and Disease of Fish Cultured in The Tropics*. London: Taylor and Francis.
- [9] Li, M., Wang, J., Zhu, D., & Gu, Z. 2008. Study of *Apisoma piscicola* (Blanchard 1885) occurring on fry of freshwater fishes in Hongze, China with consideration of the genus *Apiosoma piscicola* (Blanchard 1885) occurring on fry of freshwater fishes in Hongze, China with consideration of the genus *Apiosoma*, (January 2016).
- [10] Mahasri, G., Heryamin, A. & Kismiyati., 2018. Prevalensi Ektoparasit pada Udang Vaname (*Litopenaeus vannamei*) dengan Padat Tebar yang Berbeda di Tempat Penggelondongan di Kabupaten Gresik, *Journal of Aquaculture and Fish Health*, 5(2), pp. 7-13.
- [11] Mahasri, G., L. Raya, A. S. Mubarak & B. Irawan. 2008. Gambaran Patologi Insang dan Kulit Udang Windu (*Penaeus monodon* Fab.) yang Terserang Ciliata Patogen dari Famili Vorticellidae (*Zoothamnium* sp.). *Berkala Ilmiah Perikanan*, 3 (1): 95-103.
- [12] Ngo Thi Thuy An. 2009. Development of a System for Separation and Characterization of *Litopenaeus vannamei* Haemocytes. Faculty of Bioscience Engineering. Universiteit Gent. pp. 1-79.
- [13] Novita, D., T. R. Ferasyi, dan Z. A. Muchlisin. 2016. Intensitas dan Prevalensi Ektoparasit pada Udang Pisang (*Penaeus* sp.) yang Berasal dari Tambak Budidaya di Pantai Barat Aceh. *Jurnal Ilmiah Mahasiswa Kelautan dan Perikanan Unsyiah*, 1(3): pp. 268-279.

- [14] Nurhalimah. 2017. Inventariasi ektoparasit pada pendederan ikan nila merah *Oreochromis sp.* yang dipelihara pada fasilitas kolam percobaan (Skripsi). Institut Pertanian Bogor, Bogor.
- [15] Nurlaila, N., Dewiyanti, I. & Wijaya, S. 2016. Identifikasi dan Prevalensi Ektoparasit pada Udang *Vannamei* (*Litopenaeus vannamei*) di Kabupaten Aceh Besar. *Jurnal Ilmiah Mahasiswa Kelautan Perikanan Unsyiah*, 1(3), pp.388-396.
- [16] Prasadi, O. 2015. Inventarisasi Parasit pada Famili Arcidae sebagai Dasar Pengelolaan Sumberdaya Kekekangan di Karangantu dan Labuan, Banten. Doctoral dissertation. Bogor: Institut Pertanian Bogor.
- [17] Rohde, K. 1982. *Ecology of Marine Parasites*. St. Lucia, London, New York: University of Queensland Press.
- [18] Rusmiyati, S. 2011. *Mejala rupiah budidaya udang vannamei varietas baru unggulan*. Pustaka baru press, Yogyakarta.
- [19] Salam, B. & Hidayanti, D., 2017. Prevelensi dan Intensitas Ektoparasit pada Ikan Gabus (*Channa striata*) dari tangkapan alam dan budidaya. *Jurnal Sains dan Seni ITS*, 6(1), pp. 1-4.
- [20] Sarjito., Prayitno, S.B & Alfabetian, H.C.H. 2013. *Buku Pengantar Parasit dan Penyakit Ikan*. Semarang: UPT UNDIP Press.
- [21] Setyaningsih, L., Sarjito, A.H. & Condro, H. 2014. Identifikasi Ektoparasit pada Kepiting Bakau (*Scylla serrata*) yang Dibudidayakan di Tambak Pesisir Pemasang. *Journal of Aquaculture Management and Technology*, 3(3) pp. 8-16.
- [22] Sheath, D. J., D. Andreou dan J. R. Britton. Interactions of Warming and Exposure Affect Susceptibility Toparasite Infection in a Temperate Fish Species. *Parasitology*, 143: pp. 1340-1346.
- [23] Subyakto, S., Suntende D., Afandi M., Sofiati. 2009. Budidaya udang vannamei (*litopenaeus vannamei*) semi intensif dengan metode sirkulasi tertutup untuk menghindari serangan virus. *Jurnal Ilmiah Perikanan dan Kelautan*, 1(2): 121- 127.
- [24] Syukri, M. & Ilham, M., 2016. Pengaruh salinitas terhadap sintasan dan pertumbuhan larva udang windu (*Penaeus monodon*). *Jurnal Galung Tropika*, 5(2), pp.86-96.

- [25] Utami, P. 2012. Keragaman Jenis Ektoparasit pada Ikan Hasil Tangkapan di Sungai Banjaran Kabupaten Banyumas. Purwokerto: Fakultas MIPA UPBJJ
- [26] Williams, E.H.Jr., L. B. Williams. 1996. Parasites of off shore, big game fishes of Puerto Rico and the Western North Atlantic. Puerto Rico Department of Natural and Environmental Resources, San Juan, Puerto Rico, and Department of Biology, University of Puerto Rico, Mayaguez, Puerto Rico.
- [27] Wildani, D., 2017. Identifikasi ektoparasit pada ikan Patin (*Pangasius spp.*) di tambak budidaya ikan desa Lampeuneurut Kabupaten Aceh Besar. *Jurnal Ilmiah Mahasiswa Veteriner*, 1(3), pp.448-455.
- [28] Wyban, J. A. and J. N. Sweeney. 1991. *Shrimp Production Technology*. Honolulu, Hawaii. pp. 37-78.
- [29] Yanto, H. 2006. Diagnosa dan Identifikasi Penyakit Udang Asal Tambak Intensif dan Panti Benih di Kalimantan Barat. *Jurnal Penelitian Sains dan Teknologi*, 1(1): pp. 17-32

SPATIAL PLANNING INFORMATION SYSTEM IN INDONESIA

Erika Pradana Putri

Universitas Terbuka (INDONESIA)

erikap@ecampus.ut.ac.id

Abstract

Each administrative area in Indonesia has a spatial plan which is divided into spatial plans and detailed spatial plans. As the mandate of Spatial Planning Law, no 26/2007, after those plans are established, the plan must be disseminated to the public. Nowadays, is it common for administrative areas Indonesia to have spatial planning information and communication system, known as Sistem Informasi Tata Ruang (SIMTARU), to disclose the spatial plan they had. However, the SIMTARU are varied from one to another. This study aims to explore different characteristics of spatial planning information system. The method used is descriptive qualitative from samples of several SIMTARU in Indonesia. As a result, there are differences in (i) appearance (ii) information they provide, (iii) facilitate community participation

Keywords: spatial plan, SIMTARU

1 INTRODUCTION

Each administrative area in Indonesia has a spatial plan which is divided into spatial plans and detailed spatial plans. As the mandate of Spatial Planning Law, no 26/2007, after those plans are established, the plan must be disseminated to the public. One of the uses of information technology in urban or regional development planning is in delivering the spatial plan. Nowadays, is it common for administrative areas Indonesia to have spatial planning information and communication system, known as Sistem Informasi Tata Ruang (SIMTARU), to disclose the spatial plan they had. However, the SIMTARU are varied from one to another.

2 METHODOLOGY

The method used in this study is descriptive qualitative. By using the qualitative research method, this study explores samples of spatial planning information system (SIMTARU) which is owned by administrative areas in Indonesia. There were various SIMTARU were explored varied from cities, regencies, and province SIMTARU. This study tends to explore and not categorize finding.

3 RESULTS

Until present, there are no standard given by Indonesian Government regarding content and appearance of SIMTARU. Ideally, according Bukhori (2011), spatial information system must include statistic/attribute data, georeferencing spatial data, and others data not included in those two group mention earlier. Moreover, the map in spatial information system must consist of base map and thematic map. As SIMTARU conveys very important information regarding spatial planning, it must be user friendly enough so it can accessed by common people.

Commonly, SIMTARU is web and geospasial application which inform public regrading spatial plan information. Those information usually consist of local regulation in spatial planning and supported by various maps, Some of SIMTARU as well provide tool to accept people report regarding spatial planning. Others, integrate SIMTARU with permit management related with spatial activities. However as mention earlier, the appearance, content, and accommodate public participation in SIMTARU are diverse which will be explained bellow.

3.1 Appearance of Planning Information System in Indonesia

Ideally, planning information system display data in webGIS map. Map are the most suitable media to whos spatial information. However, result shows there are various appearance of Spatial Planning Information System (SIMTARU) in Indonesia. Several SIMTARU use webGIS to provide spatial information for public. Those information varied from one information system to others, common

spatial information provided are the existing land use and land use plan. By using webGIS, public can interactively learn about the spatial information. The map can be zoom in and zoom out, offered different layers in such as existing land use and land use plan. Some SIMTARU also provide 3D media. Jakarta is one example of the province that have well appearance in planning information system. There are several menu including map and 3D media. People also can download several maps in this information sistem such as administrative area map, public transportation route map, hydrology map, and many others.

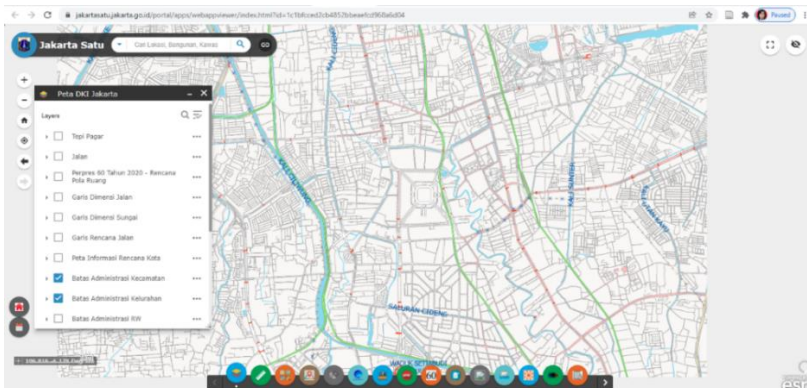

Figure 1. Use of webGIS in Jakarta Spatial Planning Information System

On the other hand, there are also several SIMTARU which had a very simple appearance. It only provides spatial information in picture format. Sometimes, the information is also limited. For example, Serang City, the SIMTARU, the spatial information provided in very simple appearance and not interactive. We need to download the map to get specific information. The map is in jpeg format.

Comparing two examples of SIMTARU, there is quite big difference between Jakarta SIMTARU and Serang SIMTARU in appearance. Jakarta SIMTARU already supports by latest technology

by using webGIS to deliver the spatial information. Although using high technology, the SIMTARU is still user friendly and easy to access by common people who want to know spatial information of Jakarta. In Serang, there was no doubt that the map was made by using GIS, however, it is not used optimally in delivering the spatial information.

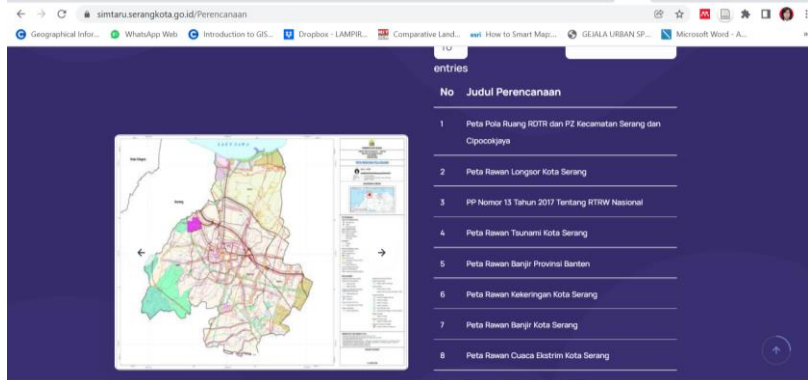

Figure 2. Serang SIMTARU only provide a map in picture format

3.2 Information Provided

Public participation in spatial planning is very important, as the mandate of Spatial Planning Law. However, to participate in the planning process, the public must understand the plan first. Research show a lack of public participation in the spatial planning process in Depok City, due to several factors including the lack of information obtained by the community in the planning process. The research also concludes that government intervention is needed in providing information related to spatial planning. Therefore, SIMTARU, as one media to disclose spatial planning in Indonesia, plays an important role. However, there is no technical standards regarding what information must be provided in the spatial planning system. This lack of standard results differentiation between one SIMTARU to another.

Spatial planning is one of information that must be provided and periodically announced to the public which will contain various

information including other general descriptions of the area (data and pictures), the contents of the Spatial Plan, spatial structure, and land use map. (Sumirat, 2014)

Research shows, most samples already provide compulsory information such as the content of the spatial plan, spatial structure, and land use map. For example, Tabalong SIMTARU provided spatial plan in legal format or local regulation, spatial structure, and land use map in an interactive format using webGIS, and complement with user guidelines.

Furthermore, another example of SIMTARU with complete information is West Sumatra Province SIMTARU that can be accessed at <https://www.todemo.online/>. This SIMTARU not only provided spatial planning in province level but also in city and regency level that part of West Sumatra. There is an interactive map with various layers and complete with regulation related with spatial plan. Therefore, public not only get information regarding the spatial plan but also get a visualization of it. Though, the interactive not shows all compulsory information, there are no spatial structure in the map, only a strategic area.

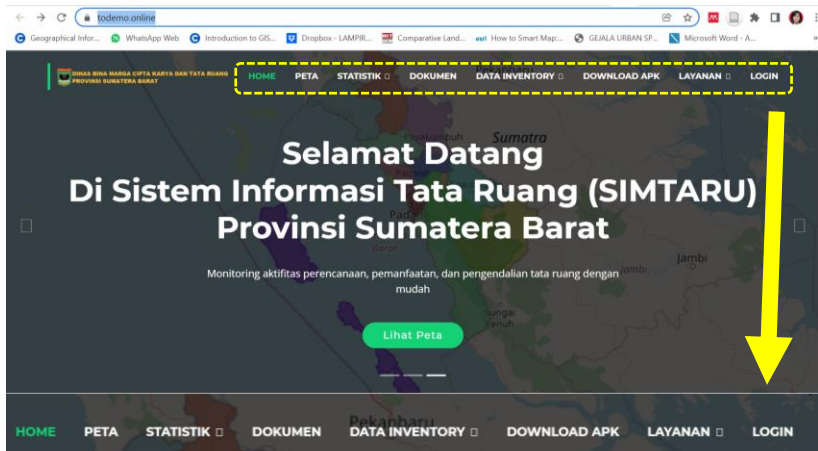

Figure 3. West Sumatra SIMTARU with complete information

However, several SIMTARU only provided minimum data. One example is Kutai Kartanegara SIMTARU that can be accessed at <https://simtaru.kukarkab.go.id/>. The landing page, it mentions that the SIMTARU is a medium for socializing spatial planning information to the community by disseminating information about spatial plans in Kutai Kartanegara Regency. However, the SIMTARU only consists of interactive map without the explanation regarding the spatial planning itself.



Figure 4. Kutai Kartanegara SIMTARU with limited information

Several SIMTARU, also provide information about permit, which related with spatial plan such as Izin Mendirikan Bangunan, Izin HO, Izin Prinsip, Izin Lokasi dan Izin Perubahan Penggunaan Tanah Pertanian ke Non Pertanian. Other also provide service related to spatial plan information. For example, Bandung City SIMTARU, that offer service for people who need Keterangan Rencana Kota. Bandung City SIMTARU also provide information required by public to propose permit, recommendation, and others that related to spatial plan in Bandung City

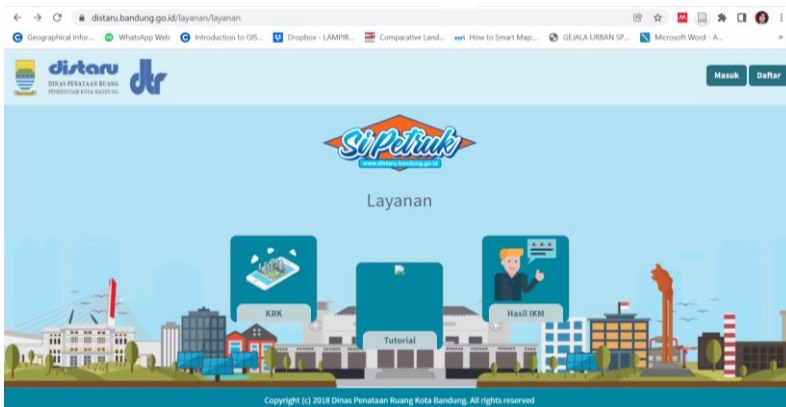
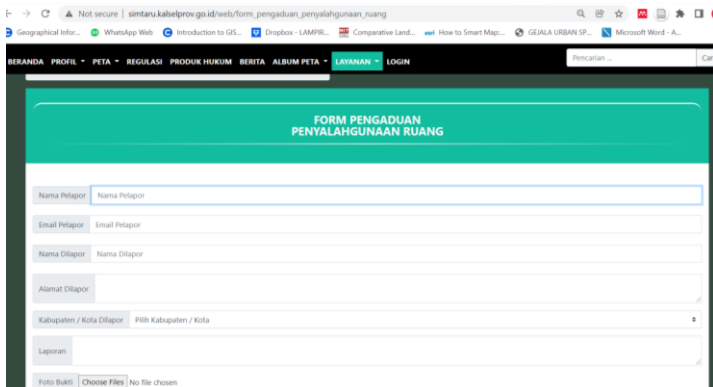

Figure 5. Service provided in Bandung Cities SIMTARU

3.3 Public Participation

Public participation in spatial planning is very important. That participation regulated in government regulation. SIMTARU can become one media to facilitate public participation in spatial planning. One form public participation in spatial planning can be reported to authorized agencies and/or officials in terms of finding violations of established spatial plan (Ameyria, 2019). Several SIMTARU provide reporting form for public such as Kalimantan Selatan SIMTARU. However, there are no feature to monitor the report process. Beside reporting violation of spatial plan, public also can participate during the planning process. When Jakarta conducted Review of Detailed Spatial Plan in 2020. Jakarta citizen can be participate in the process by input their recommendation related with spatial plan through the Jakarta SIMTARU.



The image shows a web browser window displaying the SIMTARU reporting form. The browser's address bar shows the URL: simtaru.kalselprov.go.id/web/form_pengaduan_penyalahgunaan_ruang. The page has a green header with the title "FORM PENGADUAN PENYALAHGUNAAN RUANG". Below the header, there are several input fields: "Nama Pelapor" (Name of Reporter), "Email Pelapor" (Email of Reporter), "Nama Dilapor" (Name of Reported), "Alamat Dilapor" (Address of Reported), "Kabupaten / Kota Dilapor" (District / City of Reported), "Laporan" (Report), and "Foto Bukti" (Evidence Photo) with a "Choose Files" button. The browser's navigation bar includes "BERANDA", "PROFIL", "PETA", "REGULASI", "PRODUK HUKUM", "BERITA", "ALBUM PETA", "LAYANAN", and "LOGIN".

Figure 6. Report Form for Spatial Plan Violation in Kalimantan Selatan SIMTARU

4 CONCLUSIONS

Study shows that planning information system, or widely known as Sistem Informasi Penataan Ruang (SIMTARU), in Indonesia varied, as there are no guideline regarding this from central government. It can be seen in its appearance, information provided,

and facilitating public participation. Several SIMTARU used interactive map to deliver information regarding spatial planning, others only use map in picture format that can be downloaded. Spatial planning is one of information that must be provided and periodically announced to the public, SIMTARU is one media to disclose the spatial planning. However, not all SIMTARU provide complete information such as contents of the Spatial Plan, spatial structure, and land use plan. In term of public participation, several SIMTARU provide complaint form for public. People can report violation of spatial planning in SIMTARU. However, the system not show the progress of the report. As a result, there are differences in (i) appearance (ii) provided information, (iii) facilitate public participation. There is need of standard for SIMTARU, so people get same information regarding spatial planning. However challenge may come from the public, as Indonesia still facing low digital literacy and poor internet network in some region, it can be a burden to optimize use of SIMTARU.

REFERENCES

- [1] Ameyria G. P., D., & Laelabilkis, L. (2019). Urgensi Sistem Informasi Tata Ruang (Simtaru) Sebagai Instrumen Pendukung Pengendalian Pemanfaatan Ruang di Kota Magelang. *Jendela Inovasi Daerah*, 2(1), 1-16.
- [2] Anggoro, Identifikasi Partisipasi Stakeholders dalam Penyusunan Rencana Tata Ruang Wilayah (Rtrw) Kota Depok Tahun 2012-2032, *Jurnal Online Mahasiswa bidang Perencanaan Wilayah dan Kota*, vol. 1, no 1, pp 1-7, 2016
- [3] Bukhori, Imam, Concepts of Information Systems Spatial Planning for Districts / Cities in Indonesia”, *Jurnal Tata Loka*, vol. 13, no 4, pp 224-234, 2011
- [4] Sumirat, Lambang Probo & Suhartoyo, Hengki, “Sistem Informasi Pemetaan Tata Ruang Kota-Kabupaten Dalam Bentuk Peta Grafis Berbasis Web,” *Jurnal Palimpsest*, vol. 5, no. 1, pp. 1-6, 2014.

- [5] Sistem Informasi Tata Ruang Kabupaten Kutai Kartanegara, Accessed 10 October, 2021. Retrieved <https://simtaru.kukarkab.go.id/>
- [6] Sistem Informasi Tata Ruang Kabupaten Tabalong, Accessed 14 October, 2021. Retrieved from <http://pupr.tabalongkab.go.id/simtaru/home/>
- [7] Sistem Informasi Penataan Ruang Pemerintah Kota Serang, Accessed 10 October, 2021. Retrieved from <https://simtaru.serangkota.go.id/Home>
- [8] Sistem Informasi Penataan Ruang Pemerintah Kota Bandung, Accessed 10 October, 2021. Retrieved from <https://distaru.bandung.go.id/>
- [9] Sistem Informasi Tata Ruang Provinsi DKI Jakarta, Accessed 14 October, 2021. Retrieved from <https://jakartasatu.jakarta.go.id/>
- [10] Sistem Informasi Tata Ruang Provinsi Kalimantan Selatan, Accessed 10 October, 2021. Retrieved from <http://simtaru.kalselprov.go.id/web>
- [11] Sistem Informasi Tata Ruang Provinsi Sumatera Barat, Accessed 10 October, 2021. Retrieved from <https://www.todemo.online/>

Science and Technology for Society 5.0



UNIVERSITAS TERBUKA

KEMENTERIAN PENDIDIKAN, KEBUDAYAAN, RISET, DAN TEKNOLOGI

Penerbit Universitas Terbuka
Jalan Cabe Raya, Pondok Cabe, Pamulang,
Tangerang Selatan - 15437, Banten - Indonesia
Telp. 021-7490941, Faks. 021-7490147
Website. www.ut.ac.id